Louisiana Transportation Research Center

Final Report 536

**Testing and Analysis of LWT and SCB
Properties of Asphalt Concrete Mixtures**

by

Samuel B. Cooper III, Ph.D., P.E.
William "Bill" King, P.E.
Md Sharear Kabir, P.E.

LTRC



4101 Gourrier Avenue | Baton Rouge, Louisiana 70808
(225) 767-9131 | (225) 767-9108 fax | www.ltrc.lsu.edu

TECHNICAL REPORT STANDARD PAGE

1. Report No. FHWA/LA/536		2. Government Accession No.	3. Recipient's Catalog No.
4. Title and Subtitle Testing and Analysis of LWT and SCB Properties of Asphalt Concrete Mixtures		5. Report Date April 2016	
		6. Performing Organization Code LTRC Project Number: 11-3B State Project Number: 30000220	
7. Author(s) Samuel B. Cooper III, PE; William "Bill" King, PE; Md Sharear Kabir, PE		8. Performing Organization Report No.	
9. Performing Organization Name and Address Louisiana Department of Transportation and Development P.O. Box 94245 Baton Rouge, LA 70804-9245		10. Work Unit No.	
		11. Contract or Grant No.	
12. Sponsoring Agency Name and Address Louisiana Department of Transportation and Development P.O. Box 94245 Baton Rouge, LA 70804-9245		13. Type of Report and Period Covered Draft Final August 2011 – June 2014	
		14. Sponsoring Agency Code	
15. Supplementary Notes Conducted in Cooperation with the U.S. Department of Transportation, Federal Highway Administration			
16. Abstract Currently, Louisiana's Quality Control and Quality Assurance (QC/QA) practice for asphalt mixtures in pavement construction is mainly based on controlling properties of plant produced mixtures that include gradation and asphalt content, voids filled with asphalt, air voids, moisture susceptibility tests (Modified Lottman), and roadway parameters such as pavement density [1]. These controlling properties have served Louisiana well, yet with growing interest in considering alternative paving materials such as rubber modified asphalts, reclaimed asphalt pavement (RAP), recycled shingles, and warm-mix asphalt (WMA) technologies, there is a pressing need to implement laboratory mechanical testing capable of ascertaining an asphalt mixture's ability to resist common distresses. This research presents an evaluation of LWT and SCB tests for rutting and cracking evaluation of commonly produced mixtures from around the state. This research also presents the results of a balanced mixture design methodology being developed by DOTD. A total of 51 mixtures were evaluated with both the SCB and LWT tests. With respect to LWT Testing, 46 of the 51 mixtures evaluated (90%) passed the criteria specified for acceptable rutting resistance. The criteria (10 mm at 20,000 passes for unmodified binder; 6 mm at 20,000 passes for polymer-modified binder) currently being utilized by DOTD appears to be appropriate for mixtures being produced. With respect to Semi-Circular Bend Testing, the percent of mixtures passing this criterion for mixtures containing PG 64-22, PG 70-22M, PG 76-22M and PG 82-22CRM is 38, 68, 91, and 20 respectively. For the mixtures designed according to the DOTD proposed balanced mixture design specifications, 7 out of 11 met or exceeded the cracking criteria and rutting criteria. The comparison of field and laboratory compacted specimens shows there may be an effect of specimen type on the computed J_c . This relationship would need to be further investigated before using field cores for quality assurance practices.			
17. Key Words		18. Distribution Statement Unrestricted. This document is available through the National Technical Information Service, Springfield, VA 21161.	
19. Security Classif. (of this report)	20. Security Classif. (of this page)	21. No. of Pages	22. Price

Project Review Committee

Each research project will have an advisory committee appointed by the LTRC Director. The Project Review Committee is responsible for assisting the LTRC Administrator or Manager in the development of acceptable research problem statements, requests for proposals, review of research proposals, oversight of approved research projects, and implementation of findings. LTRC appreciates the dedication of the following Project Review Committee Members in guiding this research study to fruition.

LTRC Administrator

William “Bill” King, Jr., P.E.
Materials Research Administrator

Members

Danny Smith
Luanna Cambas
Jeffrey Lambert
Don Weathers
Kim Garlington
Philip Graves
Marcia Granger

Directorate Implementation Sponsor

Janice P. Williams, P.E.
DOTD Chief Engineer

Testing and Analysis of LWT and SCB Properties of Asphalt Concrete Mixtures

by

Samuel B. Cooper III, Ph.D., P.E.

William “Bill” King, P.E.

Md Sharear Kabir, P.E.

Louisiana Transportation Research Center

4101 Gourrier Ave.

Baton Rouge, LA 70808

LTRC Project No. 11-3B

SIO No. 30000220

conducted for

Louisiana Department of Transportation and Development

Louisiana Transportation Research Center

The contents of this report reflect the views of the author/principal investigator who is responsible for the facts and the accuracy of the data presented herein. The contents do not necessarily reflect the views or policies of the Louisiana Department of Transportation and Development or the Louisiana Transportation Research Center. This report does not constitute a standard, specification, or regulation.

April 2016

ABSTRACT

Currently, Louisiana's Quality Control and Quality Assurance (QC/QA) practice for asphalt mixtures in pavement construction is mainly based on controlling properties of plant produced mixtures that include gradation and asphalt content, voids filled with asphalt, air voids, moisture susceptibility tests (Modified Lottman), and roadway parameters such as pavement density [1]. These controlling properties have served Louisiana well, yet with growing interest in considering alternative paving materials such as rubber modified asphalts, reclaimed asphalt pavement (RAP), recycled shingles, and warm-mix asphalt (WMA) technologies, there is a pressing need to implement laboratory mechanical testing capable of ascertaining an asphalt mixture's ability to resist common distresses. This research presents an evaluation of LWT and SCB tests for rutting and cracking evaluation of commonly produced mixtures from around the state. This research also presents the results of a mechanistic property complimented mixture design methodology being developed by DOTD. A total of 51 mixtures were evaluated with both the SCB and LWT tests. With respect to LWT Testing, 46 of the 51 mixtures evaluated (90%) passed the criteria specified for acceptable rutting resistance. The criteria (10 mm at 20,000 passes for unmodified binder; 6 mm at 20,000 passes for polymer-modified binder) currently being utilized by DOTD appears to be appropriate for mixtures being produced. With respect to Semi-Circular Bend Testing, the percent of mixtures passing this criterion for mixtures containing PG 64-22, PG 70-22M, PG 76-22M and PG 82-22CRM is 38, 68, 91, and 20 respectively. For the mixtures designed according to the DOTD proposed balanced mixture design specifications, 7 out of 11 met or exceeded the cracking criteria and rutting criteria. The comparison of field and laboratory compacted specimens shows there may be an effect of specimen type on the computed J_c . This relationship would need to be further investigated before using field cores for quality assurance practices.

ACKNOWLEDGMENTS

This work was supported by the Louisiana Transportation Research Center in cooperation with the Louisiana Department of Transportation and Development and the Federal Highway Administration. The authors would like to acknowledge the efforts of William Gueho, Patrick Frazier, and Jeremy Icenogle at LTRC asphalt laboratory as well as the contributions of Engineering Material Characterization and Research Facility staff. Special thanks to Patrick Icenogle, P.E., for his contribution in the development of analysis packages to improve data analyses.

IMPLEMENTATION STATEMENT

LTRC began using the LWT device as a research tool before 2000. The device has also been used in Louisiana as a forensics investigative tool, providing a good predictor of pavement performance. Texas DOT adopted the use of the LWT device in their mix designs and mixture production in 2004 [2]. The outcome of this study is to provide Louisiana a requirement for the use of the LWT for quality acceptance as part of the Standard Specifications.

LTRC has been using the SCB test as a research tool since 2004. It has been used in several research projects as a predictor of intermediate temperature cracking of asphalt mixtures. The adaptation of this test protocol to a more economical and commonly used Marshall Load frame device provides another tool for quality acceptance and mixture design.

DOTD's current mixture design practices, per Superpave's guidelines, are strictly volumetric in nature. Research has shown these volumetric criteria may not capture a mixture's ability to resist distresses such as rutting and premature cracking. Therefore, a framework for a more balanced approach to mixture design is required. DOTD has proposed specification changes which would include laboratory testing to evaluate the rutting and intermediate temperature cracking resistance of the mixture. LTRC has recommended the use of LWT and SCB test to satisfy these criteria.

TABLE OF CONTENTS

ABSTRACT	iii
ACKNOWLEDGMENTS	v
IMPLEMENTATION STATEMENT	vii
TABLE OF CONTENTS	ix
LIST OF TABLES	xi
LIST OF FIGURES	xiii
INTRODUCTION	1
OBJECTIVE	3
SCOPE	5
METHODOLOGY	7
Background	7
DOTD Volumetric Mixture Design	7
Balanced Mixture Design (BMD).....	7
Fracture Testing	9
Project Description	10
DOTD BMD Mixtures	11
Experimental Evaluation	14
Hamburg Loaded Wheel Tester (LWT).....	14
Semi-Circular Bend Test.....	14
Adaptation to Alternative Load Frame	16
DISCUSSION OF RESULTS.....	19
Laboratory Performance.....	19
Loaded Wheel Tester	19
Semi-Circular Bending	20
Equipment Comparison	22
Effect of Specimen Type on Laboratory Performance	22
Balanced Mixture Analysis	24
CONCLUSIONS.....	27
RECOMMENDATIONS	29
ACRONYMS, ABBREVIATIONS, AND SYMBOLS	31
REFERENCES	33
APPENDIX A.....	35
Draft SCB Test Procedure.....	35

LIST OF TABLES

Table 1 DOTD volumetric specifications	9
Table 2 Mixture descriptions	10
Table 3 Job mix formulas	13

LIST OF FIGURES

Figure 1 Balanced mixture objectives.....	9
Figure 2 Pilot project locations.....	11
Figure 3 Mixture gradations – pilot field projects.....	12
Figure 4 Semi-circular bending test.....	15
Figure 5 Semi-circular bending specimen preparation steps.....	16
Figure 6 Semi-circular bend – Humboldt load frame.....	17
Figure 7 LWT test results.....	20
Figure 8 LWT test results – binder grade comparison.....	20
Figure 9 SCB test results.....	21
Figure 10 Fracture performance – binder grade comparison.....	21
Figure 11 Fracture performance – testing device comparison.....	22
Figure 12 Rutting performance – field core comparison.....	23
Figure 13 Fracture performance – field core comparison.....	24
Figure 14 Balance mixture analysis.....	25

INTRODUCTION

A balance of both rut and crack resistance in response to the traffic loads and environment conditions is required by the pavement to perform well in the field. With increased use of reclaimed binder from reclaimed asphalt pavement (RAP), controlling volumetric properties of Hot Mix Asphalt (HMA) mixture is not enough to ensure good pavement performance. DOTD volumetric specifications were designed to target rutting as the major distress impacting Louisiana roadways. However, an adverse effect of that specification was the production of “dry” mixtures. The reduced asphalt content in the mixtures resulted in questionable durability of the roadway.

A possible solution would be the development of laboratory test procedures to evaluate the as-built pavement-qualities to predict pavement performance and life. In so doing, numerous agencies in the country use the Loaded Wheel Test (LWT) to evaluate the rutting potential and moisture susceptibility of HMA mixtures [2, 3]. This test has shown potential to be used as a verification tool for mixture design as well as QC/QA practices. Since 2004, the Texas Department of Transportation (TXDOT) has successfully included the LWT (Hamburg type) in their Standard Specification for HMA mixtures [4]. Based on the available data, the specification was set to allow the maximum rutting value of 12.5 mm at 20,000, 15,000 and 10,000 passes for mixtures containing PG 76-22, PG 70-22, and PG 64-22 binders respectively.

Similar to rutting, fatigue cracking of HMA pavement is another major concern as the infiltration of water through the cracks can cause rapid deterioration of the pavement and the underlying structure. The fatigue cracking process includes two phases: (1) Crack initiation in which microcracks grow from microscopic size until a critical length is reached, and (2) Crack propagation that a single crack or a few cracks grow until the crack(s) progress through the pavement layer. In the event that the cracks become large enough to impact stability they are called macrocracks. Both microcracks and macrocracks can be propagated by tensile or shear stresses or their combinations. Unfortunately, there is a lack of rapid, simple, practical and performance related test procedures to characterize the crack resistance of asphalt mixtures. The Semi-Circular Bend (SCB) test, adopted by Mohammad et al. has shown promise in predicting the fracture resistance of asphalt pavements [5, 6]. This test is a traditional strength of materials approach that accounts for the flaws, represented by a notch of a certain depth, which in turn reveals the resistance of the material to crack propagation. The fracture resistance of a material is represented by the term, the critical value of J-integral (J_c), and a greater J_c value represents a better fracture resistance of the material. Note that,

previous fracture resistance data from other studies indicated that any mixture achieving a J_c value greater than 0.5 kJ/m^2 is expected to exhibit good fracture resistance [5-7]. However, the complexity of the sample preparation and computation of test results prevents a routine implementation of this test in the real world pavement construction work. As part of this study, an attempt was made to develop a simplified and reasonable SCB test procedure so that the commonly used Marshall Load frame device could be adapted for testing.

OBJECTIVE

The objective of this research was to evaluate the Loaded Wheel Tracker (LWT) and a simplified Semi-Circular Bend (SCB) test as an end result parameter for testing asphalt concrete mixtures. In addition, complimenting volumetric mixture design with mixture properties was evaluated using field projects from across the state.

SCOPE

To achieve the objectives of this study, historic LWT and SCB data from the LTRC database were utilized along with data generated from eleven plant-produced mixtures from six field projects. Mixture details of the eleven field mixtures are provided in the methodology section of this report. The LWT and SCB were conducted on plant produced mixtures and roadway cores for the 11 mixtures. Forty mixtures were evaluated from the LTRC database. Eleven mixtures from six field projects were evaluated. In total, 51 mixtures were evaluated with both the SCB and LWT tests. It is noted, the nominal maximum aggregate size (NMAS) and RAP contents varied throughout the mixtures evaluated. In addition, the laboratory produced mixtures typically did not contain RAP.

METHODOLOGY

Background

The mixtures evaluated in this study were prepared using two design practices. Conventional volumetric based Superpave design methodologies were utilized for mixtures evaluated from historic data from the LTRC database and general contractor provided mixtures. A proposed mixture properties based approach was evaluated for 11 of the mixtures. Descriptions of the two methodologies, as well as background for the balanced mixture design approach follows.

DOTD Volumetric Mixture Design

The mixtures evaluated in this study were designed according to AASHTO PP 28 “Standard Practice for Designing Superpave HMA” and Section 502 of the 2006 Louisiana Standard Specifications for Roads and Bridges [1]. The optimum asphalt cement content was determined based on volumetric (VTM = 2.5 - 4.5 percent, VMA \geq 12%, VFA = 68% -78%) and density (%Gmm at Ninitial \leq 89, %Gmm at Nfinal \leq 98) requirements. Aggregates commonly used in Louisiana (siliceous limestone, granite, sandstone, river gravel, and coarse natural sand) were used in mix preparation. In addition, consistent with DOTD specifications, aggregate testing was conducted to verify aggregate consensus properties. Consensus properties included coarse aggregate angularity (CAA), fine aggregate angularity (FAA), flat and elongated particles (F&E), and sand equivalency (SE).

Balanced Mixture Design (BMD)

A balance of both rut and crack resistance in response to the traffic loads and environment conditions is required by a pavement to perform well in the field. Controlling volumetric properties of asphalt mixture is not enough to ensure good pavement performance. A possible solution would be the development of laboratory test procedures to evaluate the as-built pavement-qualities to predict pavement performance and life. The balanced mixture design methodology combines the volumetric requirements of Superpave with the added task of mixture laboratory performance property testing.

Studies have shown achieving mixture designs that satisfy rutting, cracking and volumetric criteria are possible [8-13]. Walibuta et al. conducted extensive laboratory and field testing of asphalt mixtures constructed in an accordance with TXDOT specifications [10]. The research included the development of specification criteria (LWT and Texas Overlay Tester (OT)) modification to generate more balanced mixtures.

The LWT was used to evaluate rutting potential while the OT was used to evaluate resistance to fatigue cracking. Accelerated testing was conducted to evaluate field performance of the mixtures. Results of the experimental program indicate the balanced mixture design (BMD) method resulted in mixtures with superior cracking resistance and constructability when compared to conventionally designed mixtures [10].

Zhou et al. evaluated the effects of BMD procedures on 11 commonly used TXDOT mixtures [11]. The mixtures were designed to meet LWT and OT in addition to TXDOT volumetric criteria. The study found BMD methodologies typically resulted in higher optimum asphalt content as compared to volumetric analysis alone. Overall, the research stated balanced mixtures are achievable provided acceptable materials (i.e., aggregates, and asphalt cement) are used in the mixture design process [11].

Scullion further evaluated the use of BMD methodologies for crack attenuating mixtures (CAM) [12]. The research concluded a CAM with asphalt content of 8.3% under conventional design methodologies experienced a reduction in optimum asphalt content (7.5%) under BMD methodology. The research also noted a balanced mixture was not achieved when using a PG 70-22 binder. However, a balanced mixture was achieved utilizing a PG 76-22 binder [12].

Blankenship evaluated the effect of increasing the density of a mixture to improve laboratory performance by increasing the design asphalt content [13]. The mixture was evaluated using beam fatigue, dynamic modulus, and flow number. The research concluded a more balanced mixture could be achieved through increase density and asphalt content [13].

DOTD has proposed the use of LWT and SCB tests to evaluate the balance of mixtures designed with conventional volumetric criteria, Figure 1.

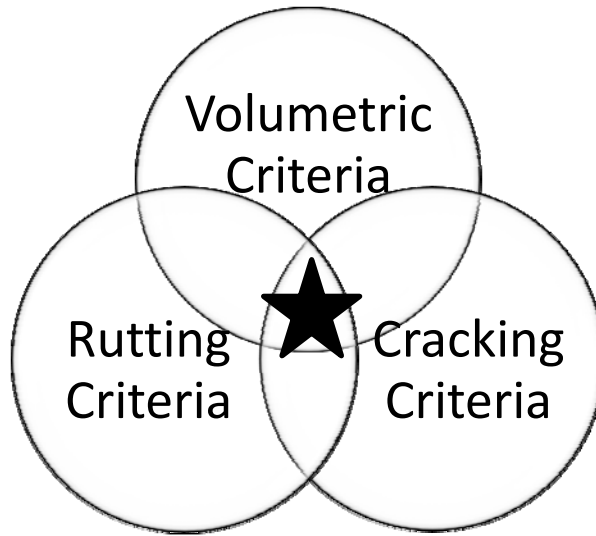

Figure 1
Balanced mixture objectives

New specification criteria proposed by DOTD were evaluated. Table 1 presents proposed modifications to the DOTD volumetric mixture design specifications. It is noted that the required specifications are based on the type of mixture and its intended use (i.e., binder or wearing course, traffic level, etc.). Lately, DOTD has been concerned with asphalt pavements developing premature cracking. To address this concern, DOTD proposed specification changes to increase the effective binder content of asphalt mixtures to address cracking potential while considering possible impacts to rutting.

Table 1
DOTD volumetric specifications

Property	2006 Superpave Specifications	2013 Proposed BMD Specifications
Ndesign, Gyration	75 – 100 ^a	65 – 75 ^a
Minimum VMA, %	10 – 13 ^a	10.5 – 13.0 ^a
VFA, %	68 – 78	69 – 80
Air Voids, %	2.5 – 4.5	2.5 – 4.5
LWT	No	Yes ^a
SCB	No	Yes ^a

^a: specification based on traffic level and mix type

Fracture Testing

There are many laboratory tests which investigate the cracking potential of asphalt mixtures. Common tests conducted include the Texas Overlay, Semi-Circular Bend,

Bending Beam Fatigue, Energy Ratio, and Fracture Energy tests. The SCB test configuration has been favored by many researchers due to the ease of sample preparation. The test can be conducted using gyratory specimens, as well as cores obtained from the field. Another benefit of the SCB is the quick and simple testing procedure [14, 15]. SCB testing offers the potential of assessing the cracking resistance of asphalt mixes in the laboratory in the design phase as well as in QA (quality assurance) testing activities. Mull et al. evaluated the semi-circular bend (SCB) configuration to characterize the fatigue crack propagation of HMA mixtures [7]. The research found that the SCB specimen is suitable for both static and fatigue fracture characterization [7].

Project Description

The laboratory performance of 51 mixtures was evaluated using the LWT and SCB test. Both laboratory and plant-produced mixtures were evaluated. Of the 51 mixtures, 11 projects were selected to utilize mixtures designed to meet the criteria of Louisiana BMD methodologies as per the proposed 2013 DOTD specifications. The remaining 40 mixtures were designed using conventional volumetric mixture design methodologies as per 2006 DOTD specifications. Table 2 presents the 11 mixtures, from six pilot field projects, designed under the DOTD proposed 2013 specification guidelines. It is noted, the nominal maximum aggregate size (NMAS) and RAP contents varied throughout the mixtures evaluated. In addition, the laboratory produced mixtures typically did not contain RAP.

Table 2
Mixture descriptions

Mixture Designation	Route	Mixture Level	NMAS, mm
LA3235BC	LA 3235	Binder	19.0
LA3235WC		Wearing	12.5
LA93BC	LA 93	Binder	19.0
LA93WC		Wearing	12.5
LA113BC	LA 113	Binder	25.0
LA113WC		Wearing	12.5
LA519WC	LA 519	Wearing	12.5
US80BC	US 80	Binder	19.0
US80WC		Wearing	12.5
LA16BC	LA 16	Binder	19.0
LA16WC		Wearing	12.5

NMAS: Nominal Maximum Aggregate Size

Figure 2 shows the locations of the six pilot field projects. Five of the projects provided both binder and wearing courses, while the sixth project only consisted of wearing course.

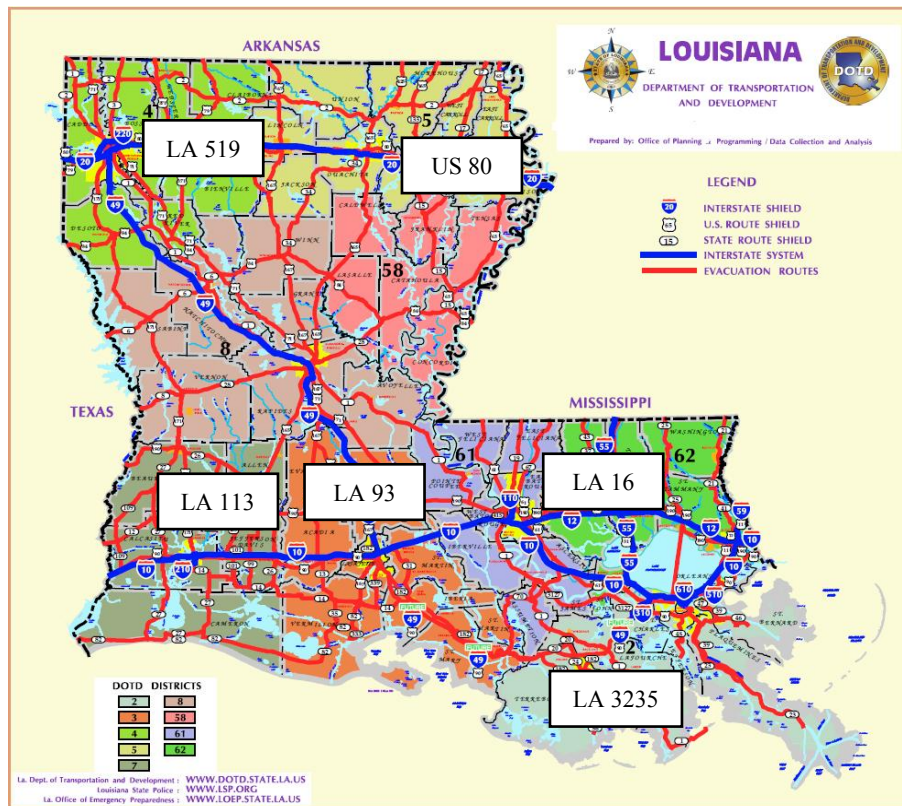
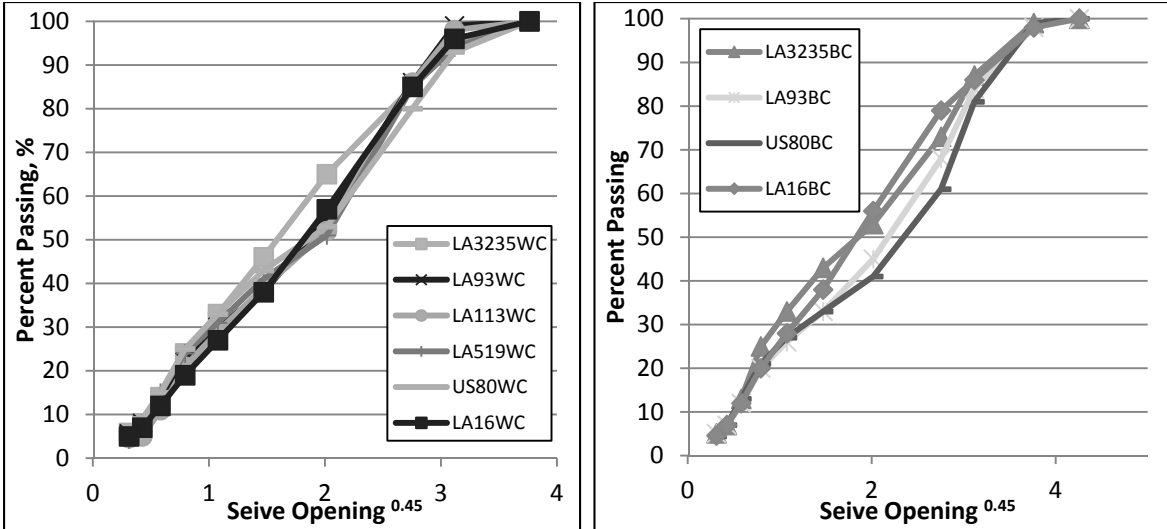

Figure 2
Pilot project locations

DOTD BMD Mixtures

Figure 3 presents the design gradations of the 11 pilot mixtures evaluated. As shown in the figure, there were six 12.5 mm mixtures, four 19 mm mixtures, and one 25 mm mixture. Table 3 presents the design job mix formulas (JMFs). It is noted that there was an increase in the values of VMA (+0.5%) and VFA (+2%) with respect to the historic mixtures produced under the 2006 DOTD specifications. In addition, the film thickness and asphalt content are greater than that of mixtures meeting the 2006 DOTD specification criteria. It is also noted the LA 113 mixtures did not contain reclaimed asphalt pavement (RAP).



a) 12.5 mm NMA

b) 19.0 mm NMA

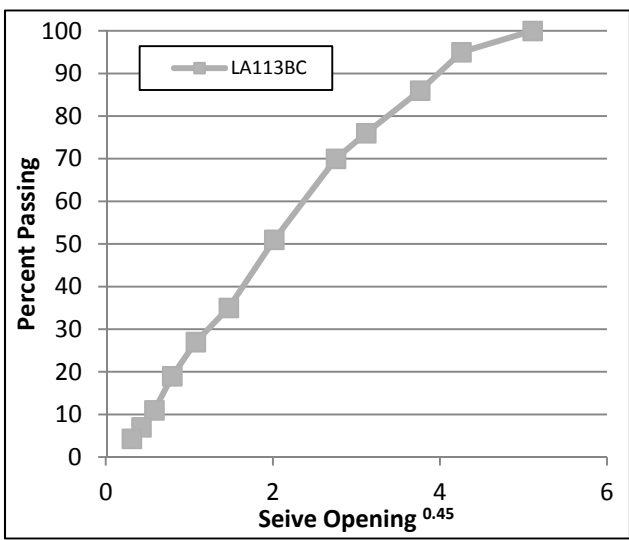

c) 25.0 mm NMA

Figure 3
Mixture gradations – pilot field projects

Table 3
Job mix formulas

Mixture Designation	LA3235 BC	LA3235 WC	LA93 BC	LA93 WC	LA113 BC	LA113 WC	LA519 WC	US80 BC	US80 WC	LA16 BC	LA16 WC
Mix Type	19.0 mm	12.5 mm	19.0 mm	12.5 mm	25.0 mm	12.5 mm	12.5 mm	19.0 mm	12.5 mm	19.0 mm	12.5 mm
Binder type	PG 70-22 M	PG 70-22 M	PG 64-22	PG 70-22 M	PG 70-22 M	PG 70-22 M	PG 70-22 M	PG 70-22 M	PG 70-22 M	PG 82-22 CRM	PG 82-22 CRM
Binder Content, %	4.4	5.2	4.2	4.6	3.7	4.6	5.2	4.4	5.1	4.9	5.5
G_{mm}	2.447	2.416	2.505	2.481	2.532	2.501	2.456	2.493	2.467	2.376	2.371
% G_{mm} at N_{vis}	90.5	89.6	88.5	88.5	87.6	88.6	89.2	89.7	89.1	88.9	88.9
% G_{mm} at N_{max}	96.5	97.2	97.3	97.5	97.5	97.7	97.7	97.4	97.4	97.2	97.3
Design air void, %	3.4	3.5	3.5	3.5	3.5	3.5	3.2	3.5	3.5	3.5	3.5
VMA, %	13.0	14.2	13.0	14.0	11.8	13.7	14.9	13.5	14.8	14.0	15.6
VFA, %	74	75	73	75	70	74	79	74	76	75	78
Metric (U.S.) Sieve	Composite Gradation Blend										
37.5 mm (1½ in.)	100	100	100	100	100	100	100	100	100	100	100
25.0 mm (1 in.)	100	100	100	100	95	100	100	100	100	100	100
19.0 mm (¾ in.)	99	100	98	100	86	100	100	99	100	98	100
12.5 mm (½ in.)	87	95	84	99	76	98	94	81	93	86	96
9.5 mm (3/8 in.)	73	85	68	86	70	86	85	61	80	79	85
4.75 mm (No. 4)	53	65	45	55	51	52	51	41	53	56	57
2.36 mm (No. 8)	43	46	33	38	35	39	41	33	43	38	38
1.18 mm (No. 16)	33	33	26	30	27	29	31	27	33	28	27
0.600 mm (No. 30)	25	24	20	22	19	21	24	21	25	20	19
0.300 mm (No. 50)	13	14	12	12	11	11	15	13	15	12	12
0.150 mm (No. 100)	7	8	7	8	7	5	8	7	9	7	7
0.075 mm (No. 200)	5.1	5.8	5.1	5.6	4.3	4.6	4.3	4.4	5.7	4.6	5.0
D.A	1.2	1.2	1.3	1.2	1.2	1.1	0.8	1.0	1.2	1.0	0.9
T_{50} micron	7.6	8.0	8.0	8.2	7.4	9.2	9.5	8.7	8.1	9.5	10.8

BC: Binder Course; WC: Wearing Course; M: Elastomeric Polymer Modified; CRM: Crumb Rubber Modified; D.A: Dust to Effective Asphalt Ratio; T_{50} : Film Thickness

Experimental Evaluation

Replicate specimens were prepared for testing. For the LWT, two specimens were tested. For SCB, four specimens at each notch depth were evaluated. All specimens were compacted to an air void level of $7.0\% \pm 0.50\%$. Results of the tests had a coefficient of variation (COV) of 20% or less. A brief description of each of the test methods considered are presented in the following sections.

Hamburg Loaded Wheel Tester (LWT)

Rutting performance of the mix was assessed using an LWT, manufactured by PMW, Inc. of Salina, Kansas. This test was conducted in accordance with AASHTO T 324, "Standard Method of Test for Hamburg Wheel-Track Testing of Compacted Hot Mix Asphalt (HMA)." This test is considered a torture test that produces damage by rolling a 703-N (158-lb.) steel wheel across the surface of a specimen that is submerged in 50°C water for 20,000 passes at 56 passes a minute. Typically, DOTD uses a maximum allowable rut depth of 6 mm at 20,000 passes at 50°C. The rut depth at 20,000 cycles was measured and used in the analysis (AASHTO T 324).

The LWT may also be used to evaluate the moisture sensitivity of the mixture. The Stripping Inflection Point (SIP), calculated from LWT test results can be used to determine the stripping potential of HMA mixtures. SIP is the number of wheel passes at which a sudden increase in rut depth occurs, (e.g., tertiary flow occurs). The SIP is related to the mechanical energy required to produce stripping; therefore, a higher stripping inflection point indicates that a mixture is less likely to strip.

Semi-Circular Bend Test

Fracture resistance potential was assessed using the SCB approach proposed by Wu et al. [16]. A draft test procedure is provided in the appendix of this report. This test characterizes the fracture resistance of HMA mixtures based on fracture mechanics principals, the critical strain energy release rate, also called the critical value of J-integral, or J_c . Figure 4 presents the three-point bend load configuration and typical test result outputs from the SCB test. To determine the critical value of J-integral (J_c), semi-circular specimens with at least two different notch depths need to be tested for each mixture. In this study, three notch depths of 25.4 mm, 31.8 mm, and 38 mm were selected based on an a/r_d ratio (the notch depth to the radius of the specimen) between 0.50 and 0.75. Test temperature was selected to be 25°C. The semi-circular specimen is loaded monotonically until fracture failure occurs under a constant cross-head deformation rate of 0.5 mm/min in a three-point bending load configuration.

The load and deformation are continuously recorded and the critical value of J-integral (J_c) is determined using the following equation [16]:

$$J_c = \left(\frac{U_1}{b_1} - \frac{U_2}{b_2} \right) \frac{1}{a_2 - a_1} \quad (1)$$

where,

b = sample thickness, mm;

a = the notch depth, mm; and

U = the strain energy to failure, kN-mm.

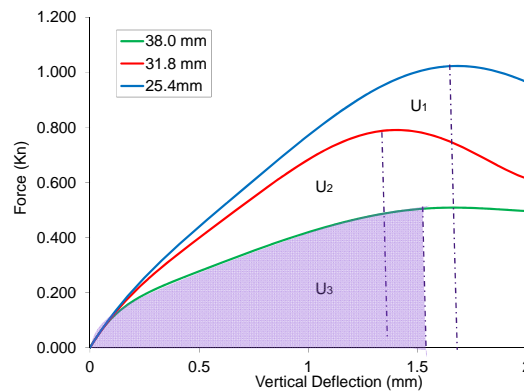

Figure 4
Semi-circular bending test

Sample Fabrication. Gyratory specimens, 150-mm diameter, are compacted to a height of 57 mm and an air void content of $7 \pm 0.5\%$. The circular specimens are then cut along the center diameter of the specimen yielding two semi-circular halves. To reduce the effect of mixture variation between specimens, each half of the specimen was designated with the same notch depth (i.e., 25.4 mm, 31.8 mm, or 38.1 mm). Four semicircular specimens were tested at each notch depth. The tolerance on the notch depth is ± 1.0 mm, while the notch width is 3.0 ± 0.5 mm. Figure 5 shows the steps used in the SCB sample preparation.



Step 1: Prepare gyratory-compacted samples



Step 2: Cut specimens along the center diameter



Step 3: Create notch with desired depth

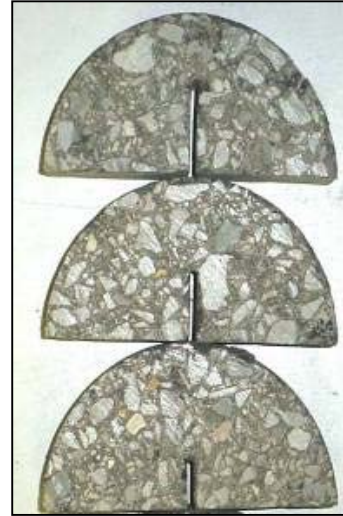

Step 4: Repeat procedure for three notch depths

Figure 5
Semi-circular bending specimen preparation steps

Adaptation to Alternative Load Frame

Typically, the SCB test is conducted on a closed-loop hydraulic material testing system (MTS). However, these systems are highly complicated, sensitive to laboratory conditions, and expensive to operate. LTRC has adapted the SCB device to the Humboldt HM-3000 Digital Master Loader typically used for Modified Lottman testing and Marshall Mixture design, Figure 6. This allows for the semi-circular bend test to be conducted in the plant or district laboratories without having to make significant additional investment. The device used should be able to record load and deformation data. It is noted, LTRC uses a data acquisition rate of 1 Hz. This data acquisition rate proves adequate to capture the load versus deformation curves required for the analysis. Also, the load frame must be able to apply a monotonic loading rate of 5 mm/min (0.02 in/min). Comparison of the J_c computed from the modified Humboldt device to that of the standard MTS system is provided in the analysis section of this report.



Figure 6
Semi-circular bend – Humboldt load frame

DISCUSSION OF RESULTS

Laboratory Performance

Loaded Wheel Tester

Figure 7 presents the results of the LWT test results at 50°C for the mixtures evaluated in this study. Mixtures designed according to the 2013 proposed DOTD specifications are indicated by star symbols. In general, historic data shows mixtures designed according to the 2006 DOTD specifications performed well in the LWT test with a mean rut depth of less than 6.0 mm (for modified asphalts) and 10.0 mm (for neat asphalts) at 20,000 passes. In addition, mixtures prepared with the BMD methodology met the respective LWT criteria. There was some concern as to whether the increase in AC would adversely affect the rutting resistance of the mixture produced under the new specifications. It is noted the 11 mixtures that were designed according to the proposed 2013 specifications (indicated by star symbols) exhibited improved or similar performance with respect to rut resistance as measured by the LWT. The 11 mixtures produced under the proposed 2013 specification criteria did not exhibit tertiary flow, thus do not exhibit moisture susceptibility as indicated by the LWT. Therefore, DOTD proposed specification modification does not appear to have adversely affected the rutting resistance of the mixtures.

Mixtures containing polymer-modified binders (i.e., PG70-22M and PG76-22M) resulted in improved performance when compared to unmodified binders (i.e., PG64-22). Figure 8 presents the average rut depths by binder grade. The figure shows a decrease in rut depth with increase in high temperature grade of the binder. This is to be expected as the LWT was conducted at a single temperature (50°C) irrespective of binder grade.

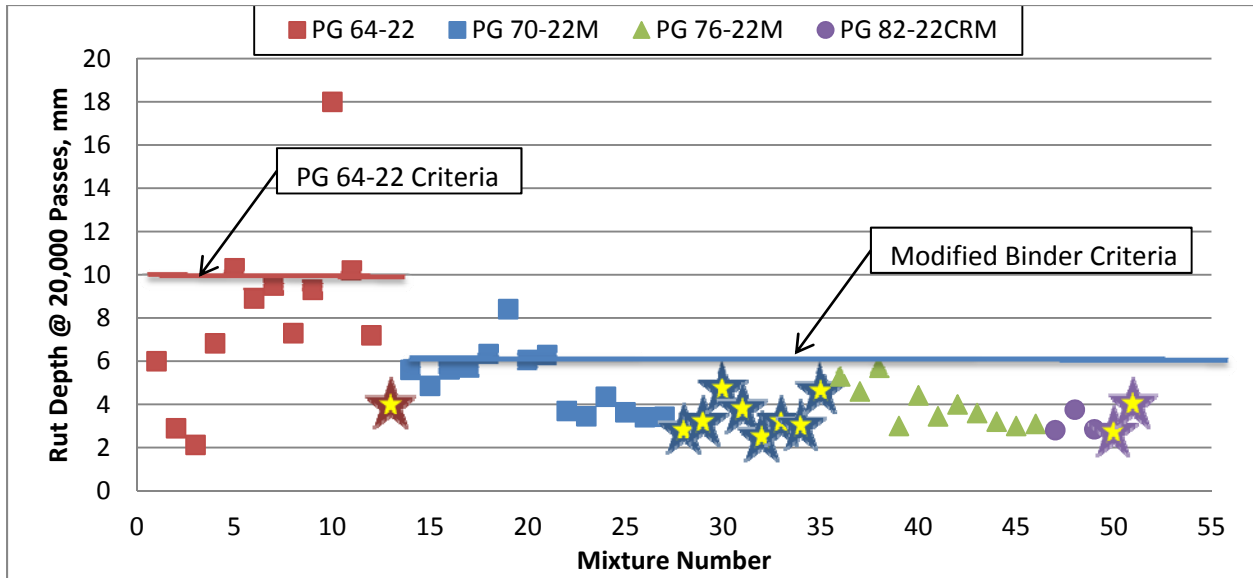

Figure 7
LWT test results

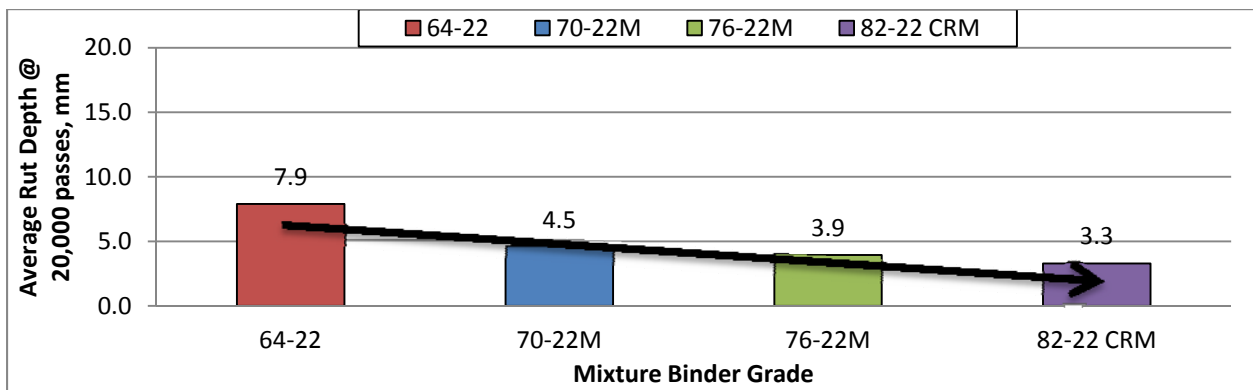

Figure 8
LWT test results – binder grade comparison

Semi-Circular Bending

Figure 9 presents the SCB test data generated for this report. The minimum passing criterion used in this analysis is 0.5 kJ/m² (17). Based on this finding a passing criteria of 0.45 kJ/m² was adopted (accounting for testing variability). Data from the LTRC database shows mixtures containing PG 70-22M binder met the criteria 71% of the time. Mixtures designed according to the proposed DOTD 2013 specifications are indicated by star symbols. This figure shows nearly 75% of the BMD mixtures met or exceeded the cracking criteria. In general, mixtures containing elastomeric type of polymer modified binder (PG 70-22M and PG 76-22M) performed better than mixtures containing other modifiers. In addition, mixtures containing crumb rubber modifiers should be monitored closely as the base binder

is a PG 64-22 without elastomeric modification. It is noted elastomeric modification of CRM blends may address these observations. Also, mixtures containing PG76-22M binder exceeded the criterion 91% of the time. For the 51 mixtures evaluated, the percent of mixtures passing this criterion for mixtures containing PG 64-22, PG 70-22M, PG 76-22M and PG 82-22CRM is 38, 68, 91, and 20 respectively. Figure 10 presents the J_c values comparison with respect to binder grade. This figure clearly identifies the effect of binder grade on cracking resistance as measured by the SCB test. The improved cracking resistance may be attributed to the elastomeric polymer modifiers used in the PG 70-22M and PG 76-22M binders. In general, mixtures containing no reclaimed asphalt pavement (RAP) exhibited improved J_c . Evaluation of the mixture components shows no influence of NMAS and aggregate type on J_c . All aggregate types and NMAS evaluated in this study produced acceptable J_c values.

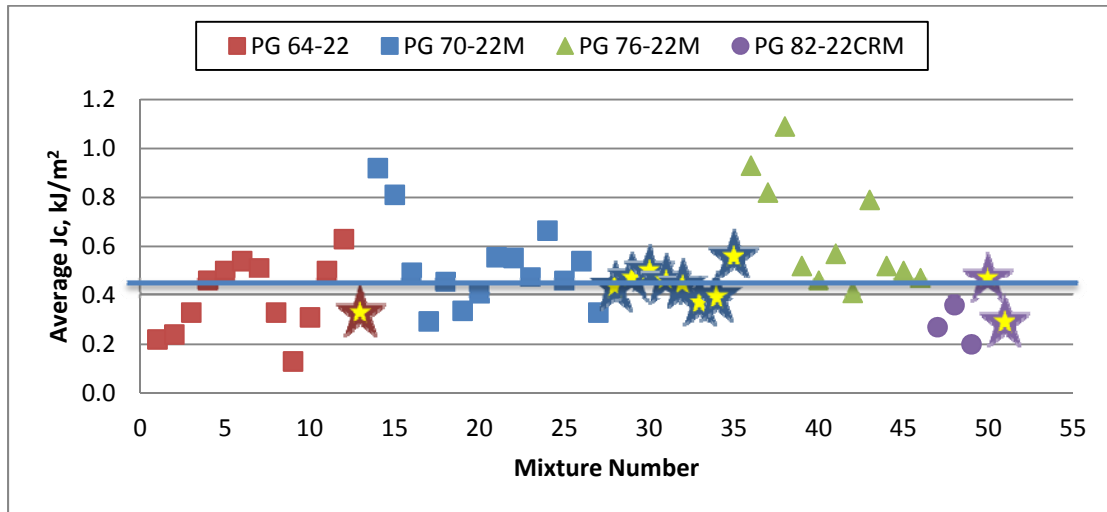

Figure 9
SCB test results

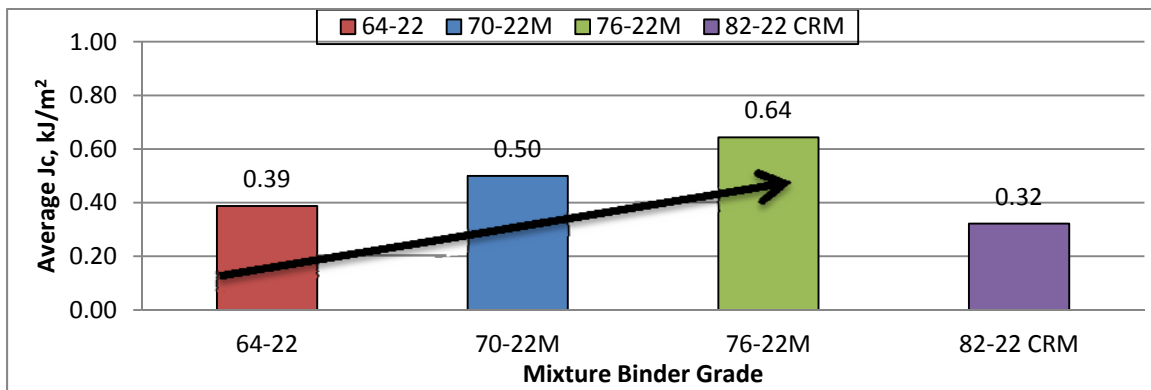

Figure 10
Fracture performance – binder grade comparison

Equipment Comparison

Comparison of multiple testing devices was conducted on a partial factorial. The mixtures evaluated were prepared using the proposed balanced mixture design specifications. Eight mixtures from four projects were used in the comparison. Figure 11 presents the results of the J_c comparison from the MTS and Humboldt load frames. The error bars represent the typical allowable error observed at LTRC (5%). In general, the J_c value of mixtures tested on the Humboldt load frame were within the acceptable error region when compared to that of mixtures tested on the MTS. It is noted the J_c computed from testing on the Humboldt device is higher than the J_c computed from mixtures tested on the MTS. This may be due to developing a proper testing apparatus for the Humboldt device. There were noticeable differences in the deformation of the first testing apparatus developed for the Humboldt. The latest device has addressed that issue and the results were greatly improved.

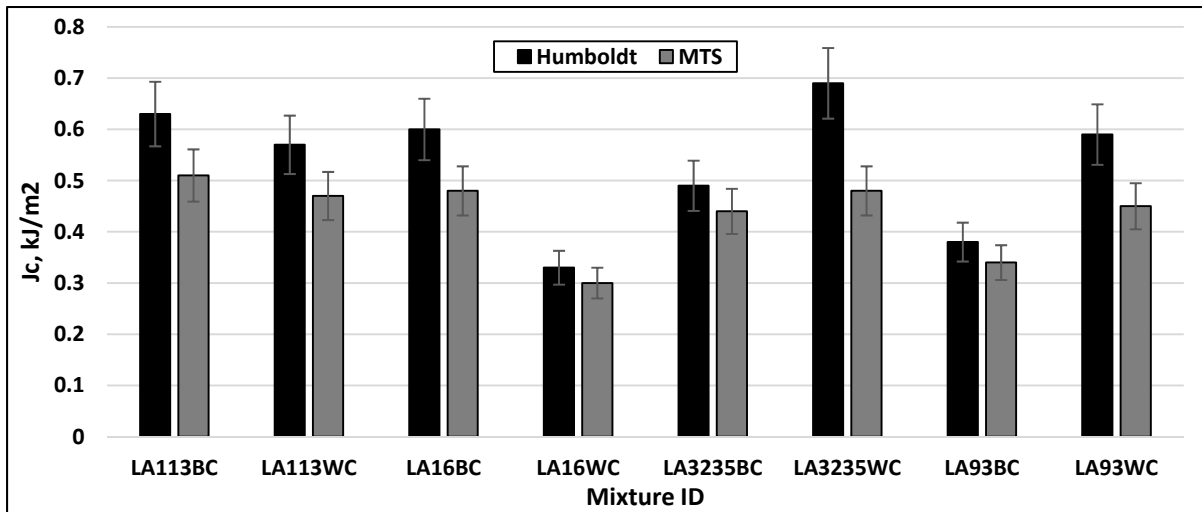

Figure 11
Fracture performance – testing device comparison

Effect of Specimen Type on Laboratory Performance

In order to properly evaluate the feasibility of these tests as possible mixture acceptance parameters, the relationship between specimens prepared from gyratory compaction and field cores taken after compaction must be understood. This will allow for the proper specification requirement during both quality control and quality assurance procedures. Figures 11 and 12 present the comparison of gyratory compacted specimens (PL) and field cores (PF) for both LWT and SCB tests respectively. Figure 12 presents the comparison of the rut depth of field compacted to plant compacted specimens. The figure shows that, generally, there is no practical difference between the rut depths of the plant-compacted specimens when compared to field-compacted specimens. With the exception of LA519WC,

both specimen types for all mixtures passed the criteria used by DOTD. The discrepancy for LA519WC is attributed to lower density of the field compacted specimen. Therefore, density is an important consideration when comparing specimen types for LWT.

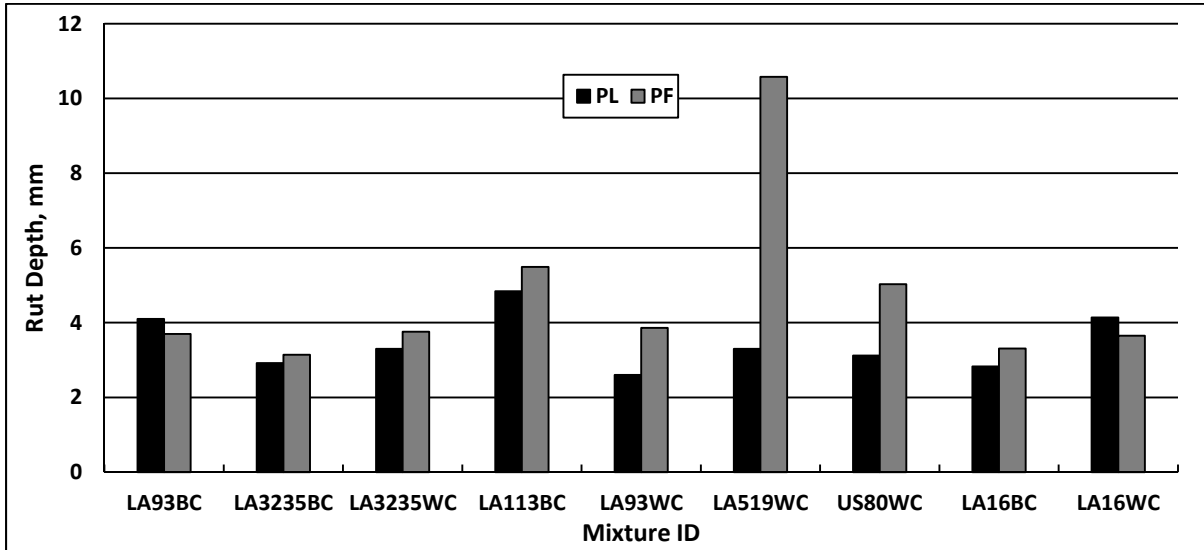

Figure 12
Rutting performance – field core comparison

Figure 13 presents the results of SCB testing from both gyratory and field compacted specimens. The comparison of the two specimen types shows there may be an effect of specimen type on the computed J_c . This finding is not unusual as many mechanistic tests vary depending on the type of compaction used. Also construction density is different than the density replicated in the lab. This relationship would need to be further investigated before using field cores for quality assurance practices. It is noted there were cases where the effect of specimen type was negligible. It is also noted that the relationship between field and laboratory did not result in a consistent trend for J_c . For some mixtures the J_c of the PF specimens was higher than that of the PL, while other mixtures exhibited the opposite trend.

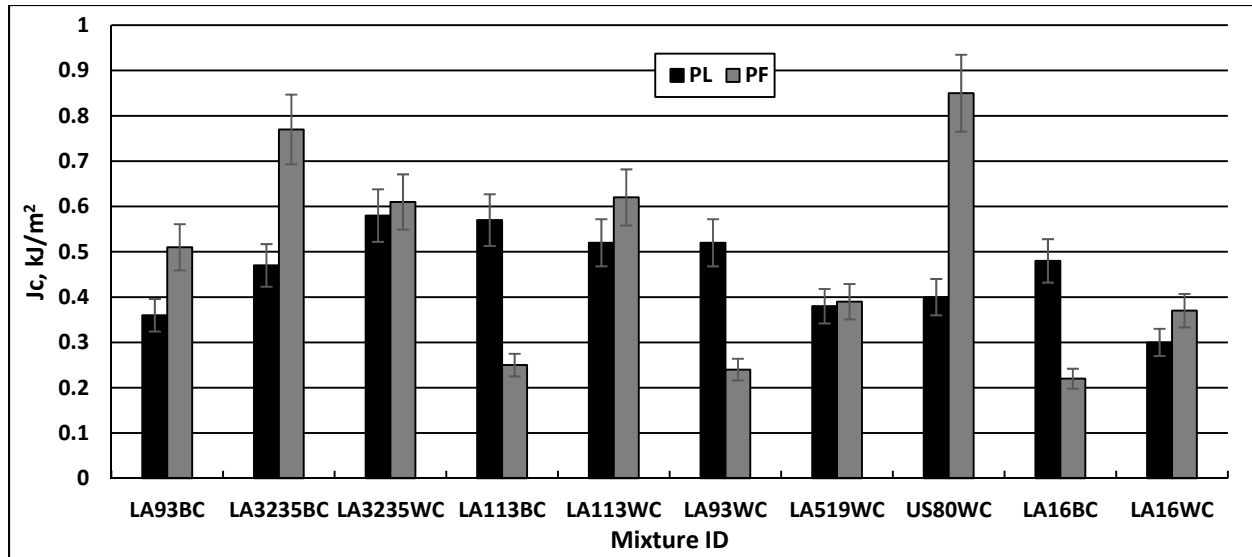

Figure 13
Fracture performance – field core comparison

Balanced Mixture Analysis

As one of the objectives of this research was to evaluate a concept for balanced mixture design methodology, Figure 14 presents the balanced mixture analysis for the 51 mixtures evaluated in this research. It is noted the 40 mixtures designed in accordance with 2006 DOTD specifications were not designed with considering LWT or SCB performance. The purpose was to determine whether mixtures produced met volumetric, laboratory rutting parameters, and laboratory field cracking parameters. All mixtures used in the study had passed the required volumetric design parameters. In Figure 14, the balanced region highlighted indicates mixtures that satisfied both rutting and fracture criteria. As shown in the figure, the mixtures designed using the 2013 proposed specification balanced 64% of the time (using the 0.45 kJ/m² criterion). It is noted that the 2013 proposed specification mixture containing PG 64-22 binder did not balance. Mixtures designed according to the 2006 DOTD specifications were balanced 52% of the time (PG 64-22-36%; PG 70-22M-50%; PG 76-22M-92%; PG 82-22CRM-0%). It is noted the percentage of PG 82-22CRM mixtures that balanced increased from 0% to 50%. However, the sample size for PG 82-22 CRM mixtures was limited.

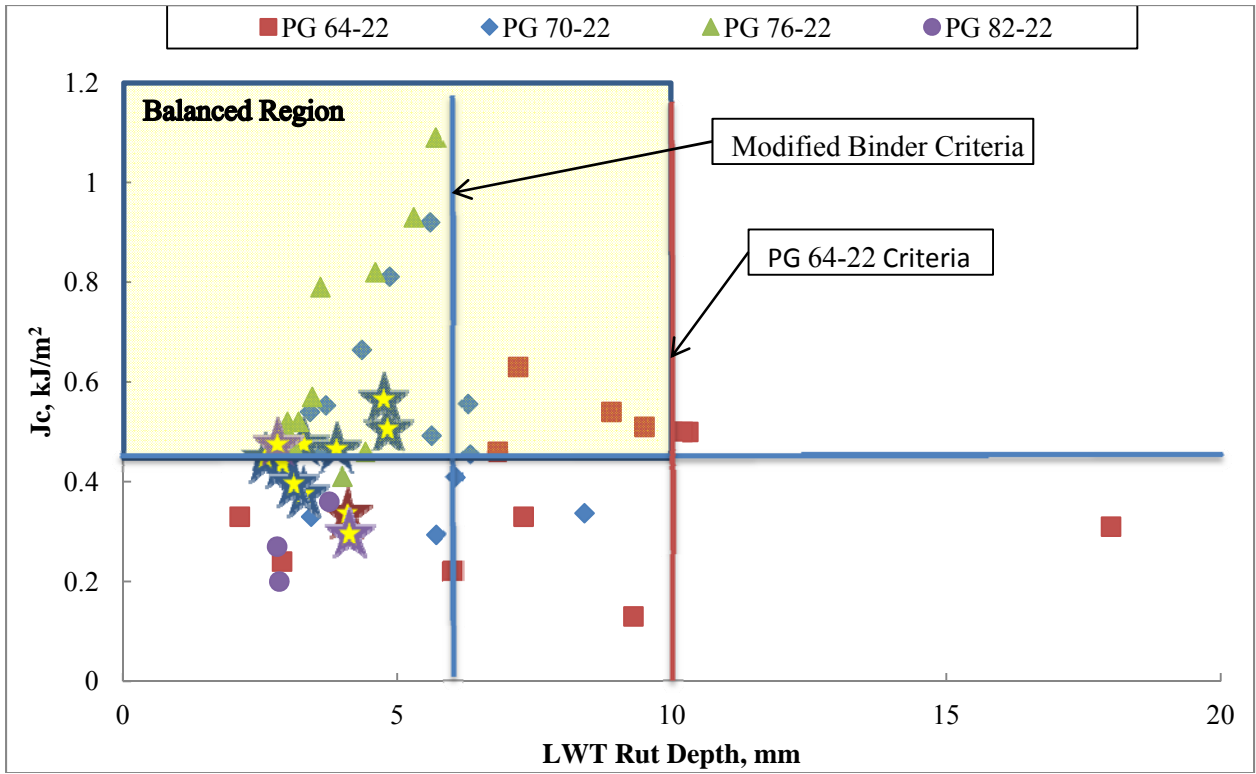

Figure 14
Balance mixture analysis

CONCLUSIONS

The objective of this research was to implement the Loaded Wheel Tracker (LWT) and to evaluate a simplified Semi-Circular Bend (SCB) tests as an end result parameter for testing Asphalt Concrete mixtures. The research focused on testing both plant produced loose mixtures as well as roadway cores. In addition, a balanced mixture design concept was evaluated using field projects from across the state. To achieve the objectives of this study, historic LWT and SCB data from the LTRC database were utilized along with data generated from eleven plant-produced mixtures from six field projects. The LWT and SCB were tested from plant produced mixtures and roadway cores for the eleven mixtures. In total, 51 mixtures were evaluated with both the SCB and LWT tests. LWT and SCB data were compared between mixtures produced under the proposed balanced mixture design specification with that of mixtures produced using the 2006 specification criteria. Based on the results of the analysis, the following findings and conclusions may be drawn:

- With respect to LWT Testing,
 - 46 of the 51 mixtures evaluated (90%) passed the criteria specified for acceptable rutting resistance. The criteria (10 mm at 20,000 passes for unmodified binder; 6 mm at 20,000 passes for polymer-modified binder) currently being utilized by DOTD appears to be appropriate for mixtures being produced.
 - Additionally, the 11 mixtures produced using the DOTD proposed design specifications exhibited improved or similar performance to mixtures produced using the 2006 DOTD specification.
 - Mixtures containing polymer modified binders (i.e., PG 70-22M and PG76-22M) resulted in improved rutting performance when compared to unmodified binders (PG 64-22).
- With respect to Semi-Circular Bend Testing:
 - Research has shown the commonly accepted criterion for acceptable cracking resistance is a J_c of 0.5 kJ/m^2 (17). The percent of mixtures passing this criterion for mixtures containing PG 64-22, PG 70-22M, PG 76-22M and PG 82-22CRM is 38, 68, 91, and 20 respectively regardless of whether they were designed for LWT or SCB. These percentages are irrespective of whether they were designed to meet LWT and SCB parameters.
 - 64% (7 out of 11) of the mixtures designed according to the DOTD proposed design specifications met or exceeded the cracking criteria (Rounding from 0.45 kJ/m^2). It is noted, two of the mixtures which failed to meet this criterion were prepared with PG 64-22 and PG 82-22CRM binder.

- Mixtures containing PG 76-22M modified binder outperformed the mixtures containing other binders (e.g., PG 64-22, PG 70-22M and PG 82-22CRM).
- The comparison of the plant v. roadway specimens shows there may be an effect of specimen type on the computed J_c . This relationship would need to be further investigated before using field cores for quality assurance practices.

RECOMMENDATIONS

Based on the findings of this research, it is recommended that DOTD implement the LWT and SCB test procedures as part of the mixture design. Primarily require the following specifications:

- For LWT testing, 6 mm at 20,000 passes for mixtures containing elastomeric polymer and crumb rubber modified binder and 10 mm at 20,000 passes for mixtures containing unmodified (PG 64-22 binder).
- For SCB testing, $J_c = 0.6 \text{ kJ/m}^2$ min for mixtures containing binder with a high temperature grade greater than PG-76. This is determined based on the majority of mixtures contained PG 76-22M resulting in J_c greater than 0.55 kJ/m^2 . A minimum $J_c = 0.5 \text{ kJ/m}^2$ (0.45 kJ/m^2 min.) is recommended for mixtures containing binder with a high temperature PG grade less than 76 (i.e. PG 70-22M and PG 64-22).

ACRONYMS, ABBREVIATIONS, AND SYMBOLS

a	notch depth
a/r_d	notch depth to the radius of the specimen ratio
AASHTO	American Association of State Highway and Transportation Officials
b	sample thickness
BC	Binder Course
BMD	balanced mix design
CAA	course aggregate angularity
CAM	crack attenuating mixtures
COV	coefficient of variation
CRM	Crumb Rubber Modified
D:A	Dust to Asphalt Ratio
DOTD	Department of Transportation and Development
F&E	flat and elongated
FAA	fine aggregate angularity
Gmm	mixture maximum specific gravity
HMA	Hot Mix Asphalt
Hz	hertz
in.	inch(es)
J_c	J-integral
JMF	job mix formula
kJ/m^2	kilojoule(s) per squared meter(s)
kJ/mm^2	kilojoule(s) per squared millimeter(s)
$\text{kN}\cdot\text{mm}$	kilonewton(s) millimeter(s)
lb.	pound(s)
LTRC	Louisiana Transportation Research Center
LWT	Loaded Wheel Test
M	Elastomeric Polymer Modified
m	meter(s)
min	minute(s)
mm	millimeter(s)
mm/min	millimeter(s) per minute(s)
MTS	material testing system
N	newton(s)
NMAS	Nominal Maximum Aggregate Size

OT	Texas Overlay tester
PF	field cores (field-compacted)
PL	gyratory compacted (plant-compacted)
QA	quality assurance
QC	quality control
RAP	reclaimed asphalt pavement
SCB	Semi- Circular Blend
SE	sand equivalency
SIP	Stripping Inflection Point
T _f	Film Thickness
TXDOT	Texas Department of Transportation
U	strain energy to failure
VFA	voids filled with asphalt
VMA	void in the mineral aggregate
VTM	voids in the total mix
WC	Wearing Course

REFERENCES

1. DOTD. "Louisiana Standard Specification for Roads and Bridges." State of Louisiana Department of Transportation and Development, Baton Rouge, LA, 2006.
2. TXDOT. "Standard Specification for Construction and Maintenance of Highways, Streets, and Bridges." Texas Department of Transportation, Texas, 2004.
3. Izzo, R.P. and Tahmoressi, M. "Testing Repeatability of the Hamburg Wheel-Tracking Device and Replicating Wheel-Tracking Devices Among Different Laboratories." *Journal of the Association of Asphalt Paving Technologists*, Vol. 68, 1999, pp.589-612.
4. Cooley Jr., L.A., Kandhal, P.S., Buchanan, M.S., Fee, F., and Epps, A. "Loaded Wheel Testers in the United States: State of the Practice." Transportation Research E-Circular, No. E-C016, Transportation Research Board, Washington, D.C., 2000.
5. Mohammad, L.N., Wu, Z., and Aglan, M.A. "Characterization of Fracture and Fatigue Resistance on Recycled Polymer-Modified Asphalt pavements." *Proceedings, 5th International Conference*, Limoges, France, 2004, pp.375-382.
6. Kim, M., Mohammad, L.N., and Elseifi, M.A. "Characterization of Fracture Properties of Asphalt Mixtures as Measured by Semicircular Bend Test and Indirect Tension Test." In *Transportation Research Record 2296*. Transportation Research Board, National Research Council, Washington, D.C., 2012, pp. 115–124.
7. Mull, M.A., Stuart, K., and Yehia, A. "Fracture Resistance Characterization of Chemically Modified Crumb Rubber Asphalt Pavement." *Journal of Materials Science*, Vol. 37, 2002, pp. 557-566.
8. Zhou, F.; Hu, S.; Scullion, T. *Integrated Asphalt (Overlay) Mixture Design, Balancing Rutting and Cracking Requirements*. Texas Transportation Institute; Texas Department of Transportation; Federal Highway Administration, 2006, 162 p.
9. Zamhari, K. A.; Dachlan, A. T.; Sterling, A. B. "Towards a Balanced Asphalt Mixture: An Indonesian Experience." *Road Engineering Association of Asia and Australasia (REAAA), Conference, 9th, 1998, Wellington, New Zealand, Volume 2, 1998, pp. 137-41*

10. Walubita, L.F.; Hoeffner, J.; Scullion, T. “New Generation Mix-Designs: Laboratory-Field Testing and Modifications to Texas HMA Mix-Design Procedures.” Texas A&M Transportation Institute, College Station, University of Texas, San Antonio; Texas Department of Transportation; Federal Highway Administration, 2013, 126 p.
11. Zhou, F.; Hu, S.; Scullion, T.; Mikhail, M.; Walubita, L.F. “A Balanced HMA Mix Design Procedure for Overlays (With Discussion).” *Journal of the Association of Asphalt Paving Technologists*, Vol 76, 2007, pp. 823-850.
12. Scullion, T. “Balanced Mix Design Report for Lufkin's Crack Attenuating Mix (CAM).” Texas Transportation Institute; Texas Department of Transportation; Federal Highway Administration, 2010, 14 p.
13. Blankenship, P.B.; Anderson, R.M.. “Laboratory Investigation of HMA Modulus, Flow Number and Flexural Fatigue on Samples of Varying Density.” *Journal of the Association of Asphalt Paving Technologists*, Vol 79, 2010, pp. 497-518.
14. Li, X.J., and Marasteanu, M.O. “Using Semi Circular Bending Test to Evaluate Low Temperature Fracture Resistance for Asphalt Concrete”, *Journal of Experimental Mechanics*, Vol. 50, 2010, pp. 867-876.
15. Adamson, R.M., Dempsey, J.P., and Mulmule, S.V. “Fracture Analysis of Semi-Circular and Semi-Circular-Bend Geometries”, *International Journal of Fracture*, Vol. 77, 1996, pp. 213-222.
16. Wu, Z., Mohammad, L.N., Wang, L.B., Mull, M.A. (2005). “Fracture Resistance Characterization of Superpave Mixtures Using the Semi-Circular Bending Test.” *Journal of ASTM International*, Vol. 2, No. 3.
17. Kim, M., Mohammad, L.M., and Elseifi, M.A. “Characterization of Fracture Properties of Asphalt Mixtures as Measured by Semicircular Bend Test and Indirect Tension Test.” Transportation Research Record 2296. Journal of the Transportation Research Board . 2012, pp. 115-124.

APPENDIX A

Draft SCB Test Procedure

Standard Method of Test for

Evaluation of Asphalt Mixture Crack Propagation using the Semi-Circular Bend Test (SCB) at Intermediate Temperature

AASHTO Designation X XXX-XX

1. SCOPE

- 1.1. This test method covers procedures for the preparation, testing, and measurement of asphalt mixture crack propagation of semi-circular specimens tested monotonically at intermediate temperature.
- 1.2. This standard may involve hazardous material, operations, and equipment. This standard does not purport to address all safety problems associated with its use. It is the responsibility of the user of this procedure to establish appropriate safety and health practices and to determine the applicability of regulatory limitations prior to use.

2. REFERENCED DOCUMENTS

2.1. AASHTO STANDARDS

- R30, Standard Practice for Mixture Conditioning of Hot-Mix Asphalt (HMA)
- T 67, Standard Practices for Load Verification of Testing Machines
- T 166, Bulk Specific Gravity of Compacted Hot Mix Asphalt Using Saturated Surface-Dry Specimens
- T 168, Sampling Bituminous Paving Mixtures
- T 209, Theoretical Maximum Specific Gravity and Density of Hot Mix Asphalt (HMA)
- T 269, Percent Air Voids in Compacted Dense and Open Bituminous Paving Mixtures

- T 312, Preparing and Determining the Density of Hot Mix Asphalt (HMA) Specimens by Means of the Superpave Gyrotory Compactor

3. SUMMARY OF TEST METHOD

- 3.1. A semi-circular specimen is loaded monotonically until fracture failure. The load and deformation are continuously recorded and the critical strain energy rate, J_c , is determined.

4. SIGNIFICANCE AND USE

- 4.1. The critical strain energy rate is used to compare the fracture properties of asphalt mixtures with different binder types.
- 4.2. This fundamental engineering property can be used as a performance indicator of fracture resistance based on fracture mechanics, the critical strain energy release rate, also known as J_c value.

5. APPARATUS

- 5.1. Load Test System- A load test system consisting of a testing machine, environmental chamber, and data acquisition system. The test system shall meet the minimum requirements specified below.

Test System Minimum Requirements	
Load Measurement and Control	Range: 0 to 25 kN
Displacement Measurement and Control	Range: 0-50mm
Temperature Measurement and Control	Range: 25°C

- 5.2. Testing Machine- The testing machine should be a closed loop system capable of applying a minimum of 4.5 kN load monotonically under a constant cross-head deformation rate of 0.5 mm/min in a three point bend load configuration.
- 5.3. Environmental Chamber- A chamber for controlling the test specimen at the desired temperature is required. The environmental chamber shall be capable of controlling the temperature of the specimen at 25°C to an accuracy of +/- 1°C.
- 5.4. Measurement System- The system shall include a data acquisition system comprising analog to digital conversion and/or digital input for storage and analysis on a

computer. The system shall be capable of measuring and recording the time history of the applied load for the time duration required by this test method. The system shall be capable of measuring the load and resulting deformations with a resolution of 0.5 percent.

- 5.4.1. Load- The load shall be measured with an electronic load cell having adequate capacity for the anticipated load requirements. The load cell shall be calibrated in accordance with AASHTO T67.
 - 5.4.2. Axial Deformations- Axial deformations shall be measured with linear variable differential transformers (LVDT).
 - 5.4.3. Temperature- Temperature shall be measured with Resistance Temperature Detectors (RTD) accurate to within +/- 1°C
- 5.5. Gyrotory Compactor- A gyrotory compactor and associated equipment for preparing laboratory specimens in accordance with AASHTO T 312 shall be used.
- 5.6. Saw- The saw shall be capable of producing three different notch sizes ranging from 0 – 50 mm. The width of the saw blade shall be 3.0mm.
- 5.7. Loading Frame- The loading frame shall consist of a loading rod and two sample support rods. The schematic of the test apparatus is shown in Figure 1. The diameters of the loading and supports rods shall be 25.4 mm and the anvil span shall be 127.0 mm.
- 5.7.1. Reaction Surface Treatment - The support rods shall contain friction reducing membranes to ensure pure bending occurs at the center of the specimen. The surface treatment shall consist of two TFE-fluorocarbon sheets or two 0.5-mm (0.02-in) thick latex membranes separated with silicone grease.

6. TEST SPECIMENS

- 6.1. Semi- circular bend testing may be performed on field cores or laboratory prepared test specimens.
- 6.2. Specimen Size- The test specimen shall be 150mm diameter and 57 mm thick.
 - 6.2.1. The semi-circular shaped specimens are prepared by slicing the 150mm by 57mm specimen along its central axis into two equal semi-circular samples
 - 6.2.2. Roadway cores can also be used if pavement is at least 57 mm.
- 6.3. Notching- A vertical notch is introduced along the symmetrical axis of each semi-circular specimen. The three nominal notch sizes are 25.4 mm, 31.8 mm, and 38.1 mm. The notch depth tolerance is ± 1.0 mm. The width of the notch shall be 3.0 ± 0.5 mm

- 6.4. Prepare four test specimens at the target air void content $\pm 0.5\%$.
- 6.5. Aging- Laboratory-prepared mixtures shall be temperature-conditioned in accordance with the oven conditioning procedure outlined in AASHTO R30. Field mixtures need not be aged prior to testing.
- 6.6. Air Void Content- Prepare four test specimens at the target air void content $\pm 0.5\%$.
- 6.7. Replicates- Four specimen should be tested at each at each notch depth (25.4-, 31.8-, and 38.1-mm).

7. PROCEDURE

Place the specimen on the bottom support, ensuring the support is centered and level (as shown in

Sample Fabrication. Gyrotory specimens, 150-mm diameter, are compacted to a height of 57 mm and an air void content of $7 \pm 0.5\%$. The circular specimens are then cut along the center diameter of the specimen yielding two semi-circular halves. To reduce the effect of mixture variation between specimens, each half of the specimen was designated with the same notch depth (i.e., 25.4 mm, 31.8 mm, or 38.1 mm). Four semicircular specimens were tested at each notch depth. The tolerance on the notch depth is ± 1.0 mm, while the notch width is 3.0 ± 0.5 mm. Figure 5 shows the steps used in the SCB sample preparation.



Step 1: Prepare gyrotory-compacted samples



Step 2: Cut specimens along the center diameter



Step 3: Create notch with desired depth



Step 4: Repeat procedure for three notch depths

Figure 5

Semi-circular bending specimen preparation steps

Adaptation to Alternative Load Frame

Typically, the SCB test is conducted on a closed-loop hydraulic material testing system (MTS). However, these systems are highly complicated, sensitive to laboratory conditions, and expensive to operate. LTRC has adapted the SCB device to the Humboldt HM-3000 Digital Master Loader typically used for Modified Lottman testing and Marshall Mixture design, Figure 6. This allows for the semi-circular bend test to be conducted in the plant or district laboratories without having to make significant additional investment. The device used should be able to record load and deformation data. It is noted, LTRC uses a data acquisition rate of 1 Hz. This data acquisition rate proves adequate to capture the load verses deformation curves required for the analysis. Also, the load frame must be able to apply a monotonic loading rate of 5 mm/min (0.02 in/min). Comparison of the J_c computed from the modified Humboldt device to that of the standard MTS system is provided in the analysis section of this report.



Figure 6
Semi-circular bend – Humboldt load frame

DISCUSSION OF RESULTS

Laboratory Performance

Loaded Wheel Tester

Figure 7 presents the results of the LWT test results at 50°C for the mixtures evaluated in this study. Mixtures designed according to the 2013 proposed DOTD specifications are indicated by star symbols. In general, historic data shows mixtures designed according to the 2006 DOTD specifications performed well in the LWT test with a mean rut depth of less than 6.0 mm (for modified asphalts) and 10.0 mm (for neat asphalts) at 20,000 passes. In addition, mixtures prepared with the BMD methodology met the respective LWT criteria. There was some concern as to whether the increase in AC would adversely affect the rutting resistance of the mixture produced under the new specifications. It is noted the 11 mixtures that were designed according to the proposed 2013 specifications (indicated by star symbols) exhibited improved or similar performance with respect to rut resistance as measured by the LWT. The 11 mixtures produced under the proposed 2013 specification criteria did not exhibit tertiary flow, thus do not exhibit moisture susceptibility as indicated by the LWT. Therefore, DOTD proposed specification modification does not appear to have adversely affected the rutting resistance of the mixtures.

Mixtures containing polymer-modified binders (i.e., PG70-22M and PG76-22M) resulted in improved performance when compared to unmodified binders (i.e., PG64-22). Figure 8 presents the average rut depths by binder grade. The figure shows a decrease in rut depth with increase in high temperature grade of the binder. This is to be expected as the LWT was conducted at a single temperature (50°C) irrespective of binder grade.

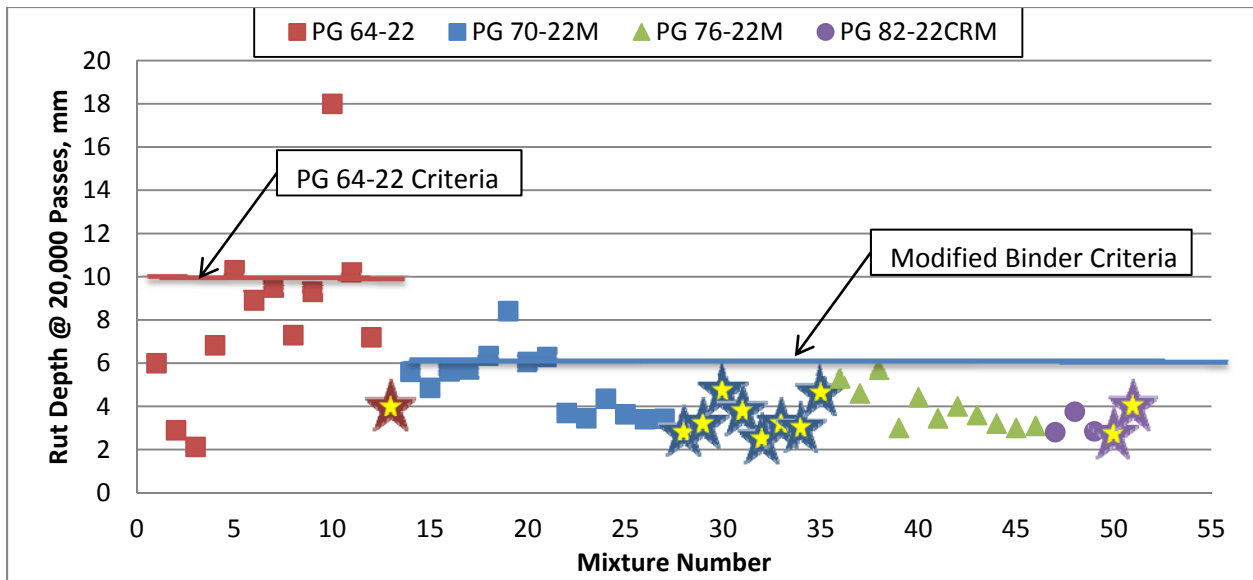

Figure 7
LWT test results

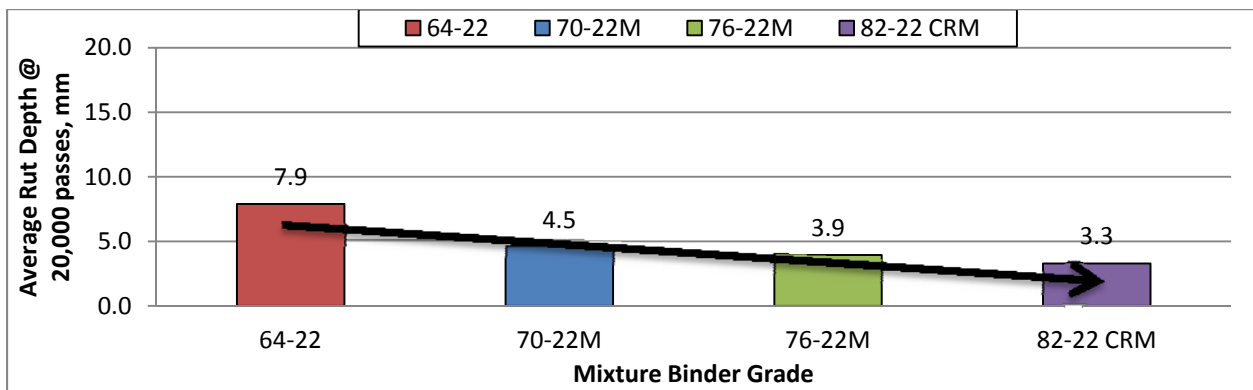

Figure 8
LWT test results – binder grade comparison

Semi-Circular Bending

Figure 9 presents the SCB test data generated for this report. The minimum passing criterion used in this analysis is 0.5 kJ/m^2 (17). Based on this finding a passing criteria of 0.45 kJ/m^2 was adopted (accounting for testing variability). Data from the LTRC database shows mixtures containing PG 70-22M binder met the criteria 71% of the time. Mixtures designed according to the proposed DOTD 2013 specifications are indicated by star symbols. This figure shows nearly 75% of the BMD mixtures met or exceeded the cracking criteria. In general, mixtures containing elastomeric type of polymer modified binder (PG 70-22M and PG 76-22M) performed better than mixtures containing other modifiers. In addition, mixtures containing crumb rubber modifiers should be monitored closely as the base binder

is a PG 64-22 without elastomeric modification. It is noted elastomeric modification of CRM blends may address these observations. Also, mixtures containing PG76-22M binder exceeded the criterion 91% of the time. For the 51 mixtures evaluated, the percent of mixtures passing this criterion for mixtures containing PG 64-22, PG 70-22M, PG 76-22M and PG 82-22CRM is 38, 68, 91, and 20 respectively. Figure 10 presents the J_c values comparison with respect to binder grade. This figure clearly identifies the effect of binder grade on cracking resistance as measured by the SCB test. The improved cracking resistance may be attributed to the elastomeric polymer modifiers used in the PG 70-22M and PG 76-22M binders. In general, mixtures containing no reclaimed asphalt pavement (RAP) exhibited improved J_c . Evaluation of the mixture components shows no influence of NMAS and aggregate type on J_c . All aggregate types and NMAS evaluated in this study produced acceptable J_c values.

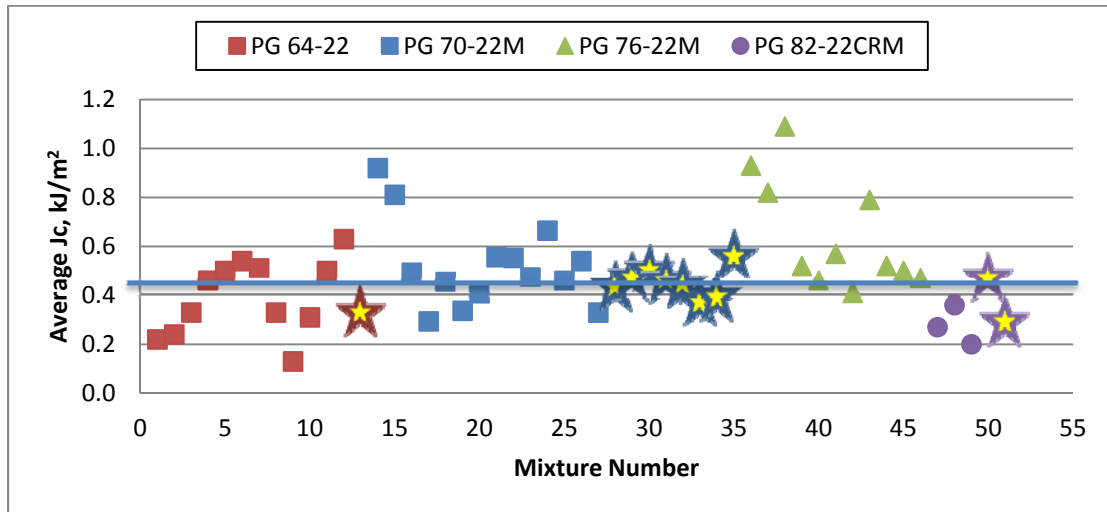

Figure 9
SCB test results

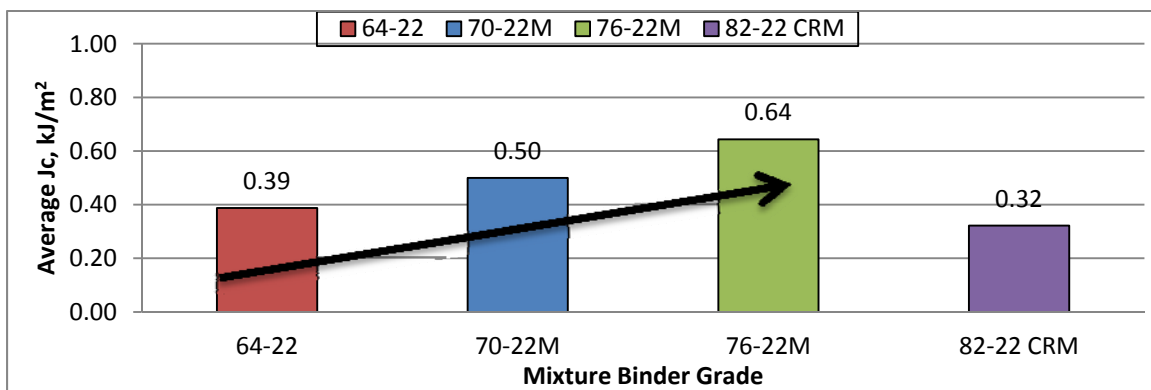

Figure 10
Fracture performance – binder grade comparison

Equipment Comparison

Comparison of multiple testing devices was conducted on a partial factorial. The mixtures evaluated were prepared using the proposed balanced mixture design specifications. Eight mixtures from four projects were used in the comparison. Figure 11 presents the results of the J_c comparison from the MTS and Humboldt load frames. The error bars represent the typical allowable error observed at LTRC (5%). In general, the J_c value of mixtures tested on the Humboldt load frame were within the acceptable error region when compared to that of mixtures tested on the MTS. It is noted the J_c computed from testing on the Humboldt device is higher than the J_c computed from mixtures tested on the MTS. This may be due to developing a proper testing apparatus for the Humboldt device. There were noticeable differences in the deformation of the first testing apparatus developed for the Humboldt. The latest device has addressed that issue and the results were greatly improved.

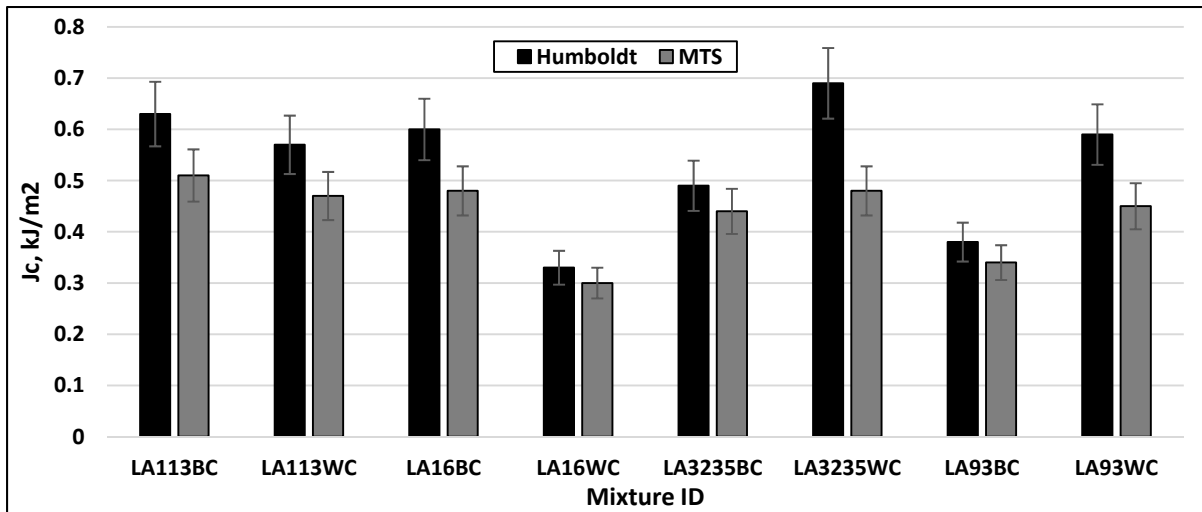

Figure 11
Fracture performance – testing device comparison

Effect of Specimen Type on Laboratory Performance

In order to properly evaluate the feasibility of these tests as possible mixture acceptance parameters, the relationship between specimens prepared from gyratory compaction and field cores taken after compaction must be understood. This will allow for the proper specification requirement during both quality control and quality assurance procedures. Figures 11 and 12 present the comparison of gyratory compacted specimens (PL) and field cores (PF) for both LWT and SCB tests respectively. Figure 12 presents the comparison of the rut depth of field compacted to plant compacted specimens. The figure shows that, generally, there is no practical difference between the rut depths of the plant-compacted specimens when compared to field-compacted specimens. With the exception of LA519WC,

both specimen types for all mixtures passed the criteria used by DOTD. The discrepancy for LA519WC is attributed to lower density of the field compacted specimen. Therefore, density is an important consideration when comparing specimen types for LWT.

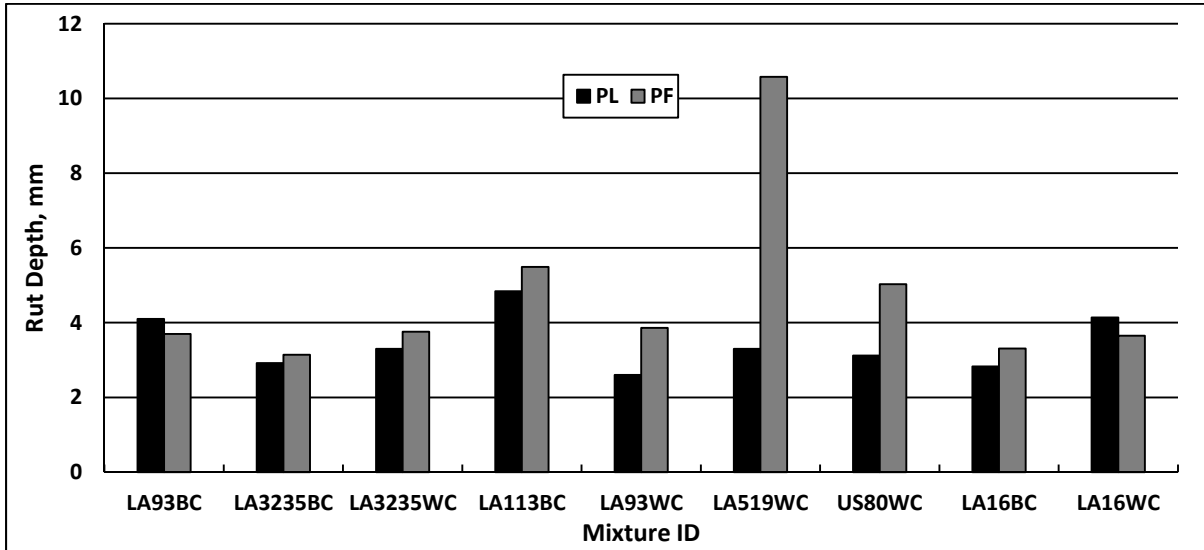

Figure 12
Rutting performance – field core comparison

Figure 13 presents the results of SCB testing from both gyratory and field compacted specimens. The comparison of the two specimen types shows there may be an effect of specimen type on the computed J_c . This finding is not unusual as many mechanistic tests vary depending on the type of compaction used. Also construction density is different than the density replicated in the lab. This relationship would need to be further investigated before using field cores for quality assurance practices. It is noted there were cases where the effect of specimen type was negligible. It is also noted that the relationship between field and laboratory did not result in a consistent trend for J_c . For some mixtures the J_c of the PF specimens was higher than that of the PL, while other mixtures exhibited the opposite trend.

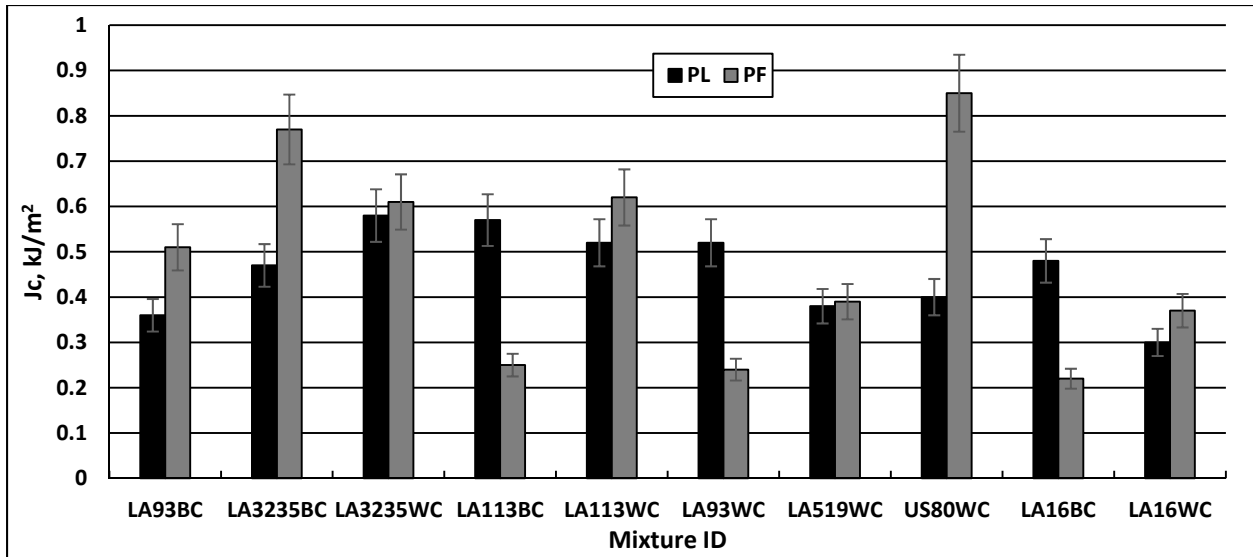
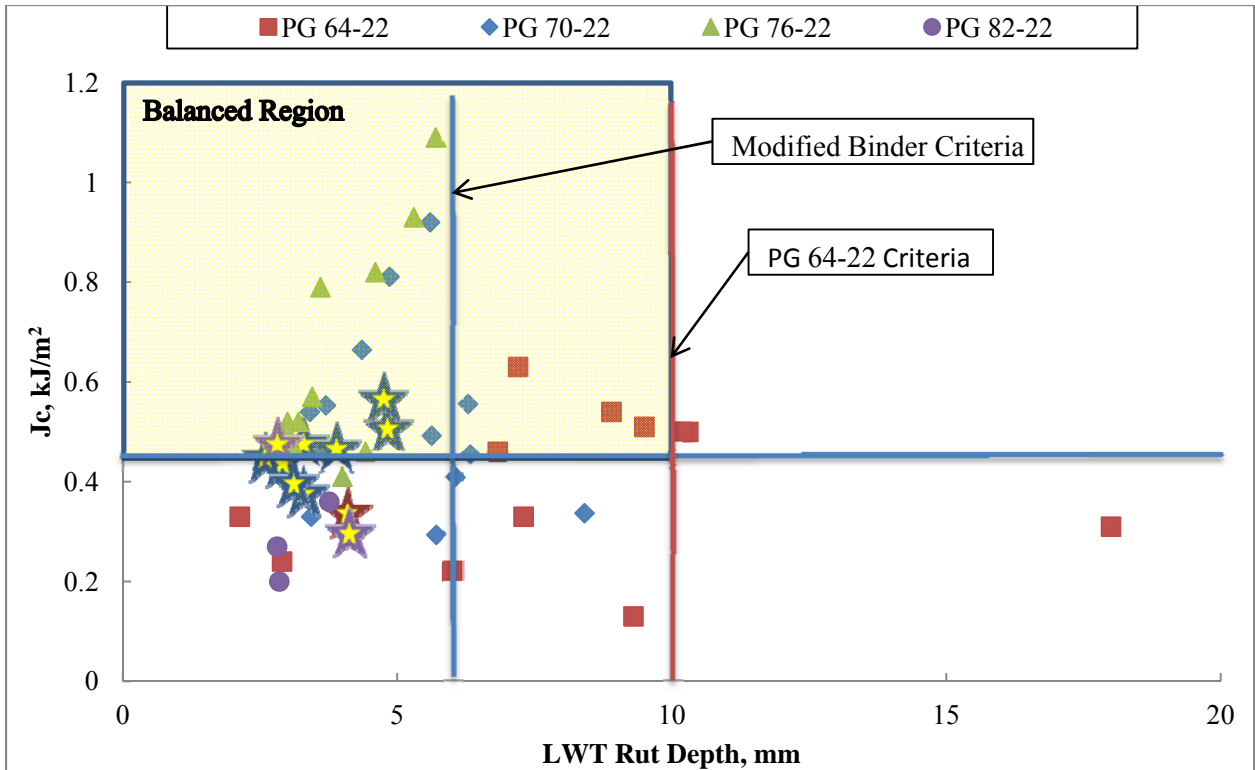

Figure 13
Fracture performance – field core comparison

Balanced Mixture Analysis

As one of the objectives of this research was to evaluate a concept for balanced mixture design methodology, Figure 14 presents the balanced mixture analysis for the 51 mixtures evaluated in this research. It is noted the 40 mixtures designed in accordance with 2006 DOTD specifications were not designed with considering LWT or SCB performance. The purpose was to determine whether mixtures produced met volumetric, laboratory rutting parameters, and laboratory field cracking parameters. All mixtures used in the study had passed the required volumetric design parameters. In Figure 14, the balanced region highlighted indicates mixtures that satisfied both rutting and fracture criteria. As shown in the figure, the mixtures designed using the 2013 proposed specification balanced 64% of the time (using the 0.45 kJ/m² criterion). It is noted that the 2013 proposed specification mixture containing PG 64-22 binder did not balance. Mixtures designed according to the 2006 DOTD specifications were balanced 52% of the time (PG 64-22-36%; PG 70-22M-50%; PG 76-22M-92%; PG 82-22CRM-0%). It is noted the percentage of PG 82-22CRM mixtures that balanced increased from 0% to 50%. However, the sample size for PG 82-22 CRM mixtures was limited.



7.1. Figure 14

Balance mixture analysis), in the environmental chamber and allow it to stabilize to 25°C. A dummy specimen with a temperature sensor mounted to its center can be monitored to determine when the specimen reaches 25°C. In the absence of a dummy specimen, a minimum of 0.5 hours from room temperature is the required temperature equilibrium time.

7.2. After temperature equilibrium is reached, apply a preload of 4.5 N to specimen to ensure the sample is seated properly. After ensuring the sample is level, release the load.

7.3. Begin to apply load to specimen in displacement control at a rate of 0.5 mm/min ensuring that time, force, and displacement are being collected and recorded for each at a sampling rate of 1 Hz. During the test have the load versus displacement plot visible, paying close attention to the peak load. Test may be terminated 120 seconds after peak load is reached.

8. CALCULATIONS

8.1. The critical value of J-integral (J_c) is determined using the following equation:

$$J_c = - \left(\frac{1}{b} \right) \frac{dU}{da}$$

where:

J_c = critical strain energy release rate (kJ/mm²);

b = sample thickness (mm);
 a = notch depth (mm);
 U = strain energy to failure (N.mm); and
 dU/da = change of strain energy with notch depth.

8.1.1. Strain energy to failure, U is the area under the loading portion of the load vs. deflection curves, up to the maximum load measured for each notch depth (shown in Figure 2).

- 8.2. The specimens are randomly clustered into 4 groups of three (one specimen at each notch depth within the grouping) before testing. Each cluster of three notch depths may be analyzed individually. The three values of U (one at each notch depth) are plotted versus their respective notch depths. The data is then modeled with a linear regression line.(shown in Figure 3). The slope of the linear regression line represents the strain energy release rate.
- 8.3. The critical value of J-integral (J_c) then computed by dividing the slope of the linear regression line (dU/da) by the specimen thickness, b .

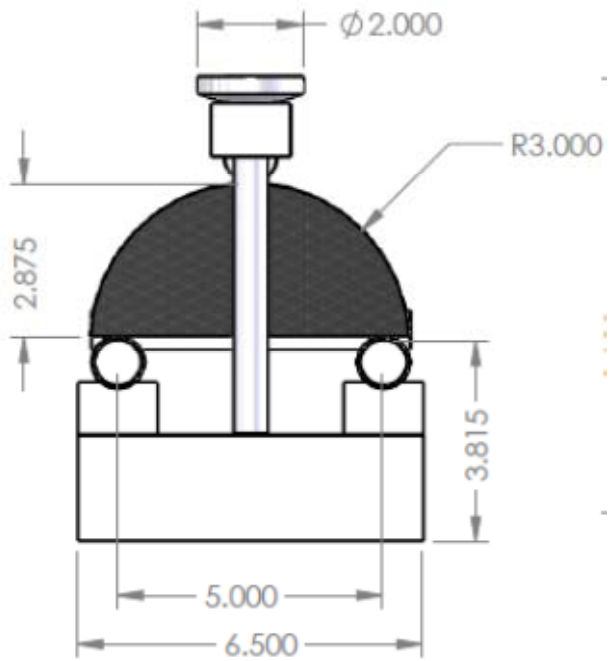
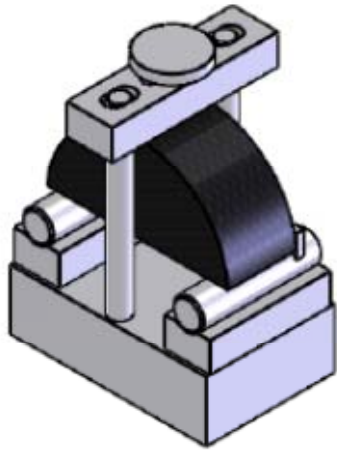

Figure 1a: Schematic of the loading apparatus

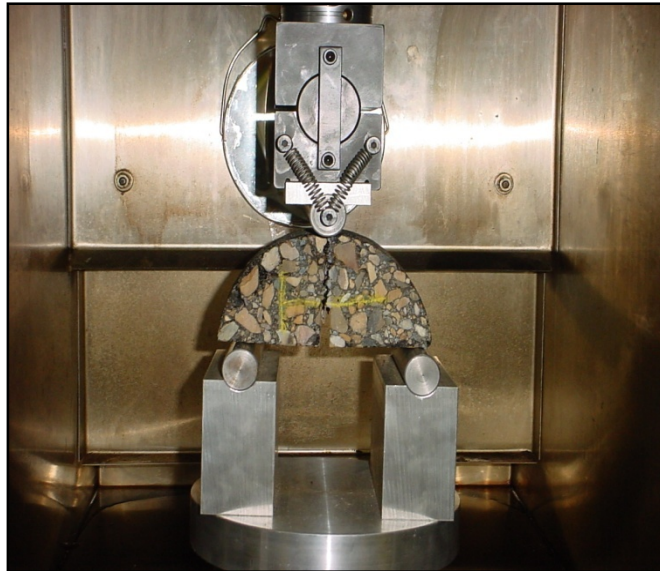

Figure 5b: Loading Position

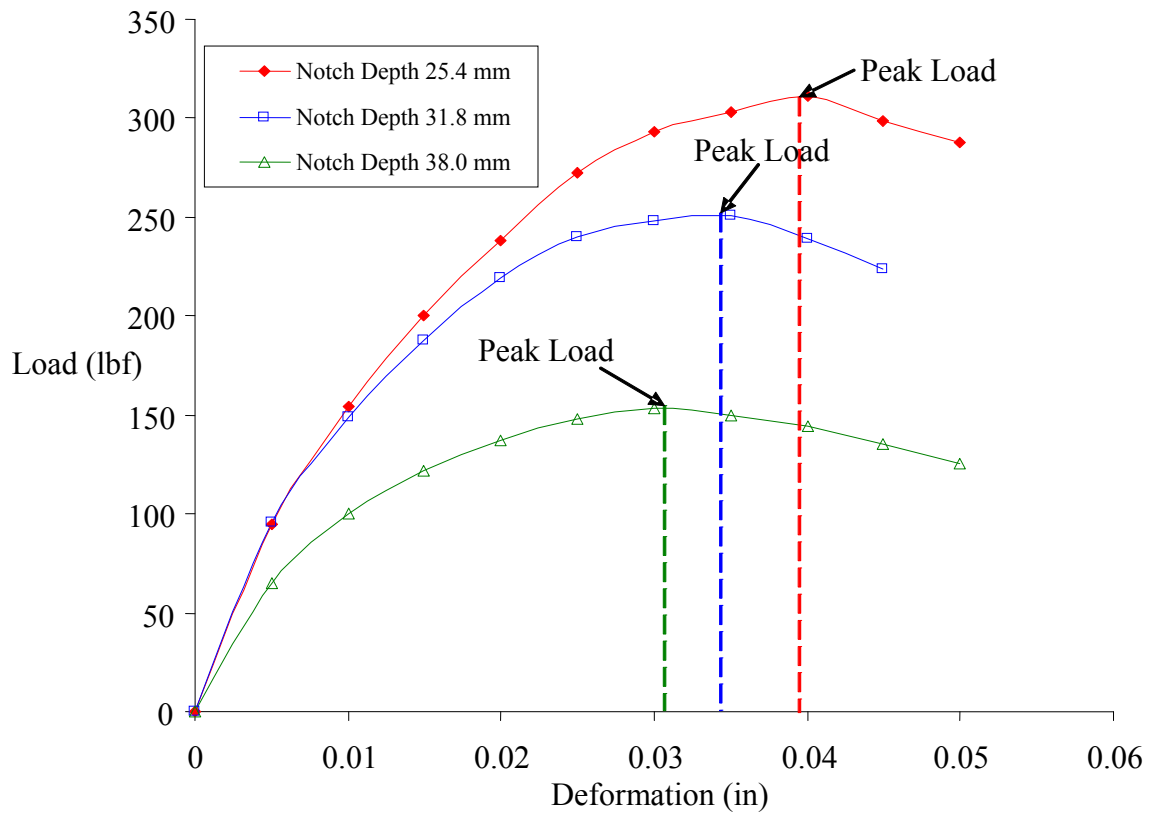

Figure 6: Deformation versus Load

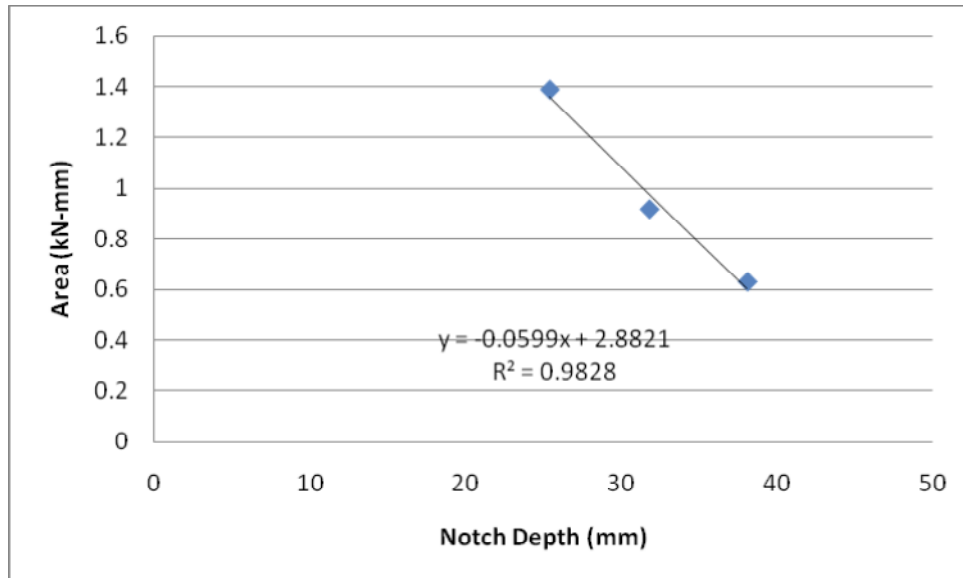

Figure 7: Notch Depth versus Area

9. REPORT

9.1. *The report shall include the following parameters:*

- 9.1.1 Asphalt Mixture Type;
 - 9.1.2 Test Temperature, °C;
 - 9.1.3 Specimen Air Voids, %;
 - 9.1.4 J_c per Notch Depth, kJ/m^2 ;
 - 9.1.5 Coefficient of Determination, R^2 ;
 - 9.1.6 Mean J_c Value, kJ/m^2 ;
 - 9.1.7 Standard Deviation of J_c ;
 - 9.1.8 Coefficient of Variation, %.
-

This public document is published at a total cost of \$250. 42 copies of this public document were published in this first printing at a cost of \$250. The total cost of all printings of this document including reprints is \$250. This document was published by Louisiana Transportation Research Center to report and publish research findings as required in R.S. 48:105. This material was duplicated in accordance with standards for printing by state agencies established pursuant to R.S. 43:31. Printing of this material was purchased in accordance with the provisions of Title 43 of the Louisiana Revised Statutes.