

# **Assessing Performance of Alternative Pavement Marking Materials**

by

Haoqiang Fu  
Post Doctoral Researcher

and

Chester G. Wilmot  
Associate Professor

Louisiana Transportation Research Center  
4101 Gourrier Avenue  
Baton Rouge, LA 70808

Technical Assistance Report No. 08-4TA

conducted for

Louisiana Department of Transportation and Development  
Louisiana Transportation Research Center

The contents of this report reflect the views of the author/principal investigator who is responsible for the facts and the accuracy of the data presented herein. The contents do not necessarily reflect the views or policies of the Louisiana Department of Transportation and Development or the Louisiana Transportation Research Center. This report does not constitute a standard, specification, or regulation.

August 2008



## EXECUTIVE SUMMARY

Pavement markings need to be restriped from time to time to maintain retroreflectivity. Knowing which material provides the most economically efficient solution is important. Currently, no agreed upon method by which to evaluate the use of alternative pavement marking materials exists. This study developed a methodology that measures the benefit of pavement marking materials based on the public perceived benefit of retroreflectivity. Using the measured benefit along with the cost of installation and impact on road users during the installation process, a benefit/cost analysis was applied to evaluate different marking materials used on Louisiana interstate freeways, including thermoplastics (both 40 mil and 90 mil), tape, and inverted profile pavement markings.

A Microsoft Excel workbook with built-in macros, named PMValue.xlsm, was developed to allow the comparison of alternative pavement marking materials for a particular application. A simple and user friendly interface enables users to specify basic information about the pavement, traffic conditions, material cost, and application schedule. Results of the analysis are presented in graphical form to assist users in assessing the performance of alternative pavement marking materials in terms of their benefit/cost ratio.

The impact of increasing the starting and six-month retroreflectivity specifications for 90 mil and tape was also estimated. The impact was measured in terms of increased pavement marking service life. The percentage of current markings that would fail the new requirement, based on current data, was also observed. An alternative specification in which the initial retroreflectivity specification is followed by a maximum percent decrease from the initial retroreflectivity in six months was also considered. The suggested specification not only sets the standard for initial retroreflectivity but also sets a limit on the decay rate of retroreflectivity.



# TABLE OF CONTENTS

EXECUTIVE SUMMARY .....	iii
TABLE OF CONTENTS.....	v
LIST OF FIGURES .....	vii
LIST OF TABLES.....	ix
INTRODUCTION .....	1
OBJECTIVES.....	3
LITERATURE REVIEW .....	5
Retroreflectivity and Its Measurement.....	5
Minimum Retroreflectivity Standard .....	6
Pavement Marking Materials .....	7
State Practices on Pavement Marking Material Selection .....	11
Pavement Marking Service Life and Its Modeling .....	13
The National Transportation Product Evaluation Program.....	19
Pavement Marking Economic Evaluation.....	22
Research in Progress .....	27
DATA .....	29
METHODOLOGY .....	33
Measuring User Benefit .....	33
Modeling Pavement Marking Retroreflectivity .....	34
Estimating User Cost.....	35
Evaluating Pavement Marking Material .....	35
Generating Equivalent Cost Factors.....	35
MODEL ESTIMATION.....	39
Estimating Pavement Marking Retroreflectivity.....	39
Estimating User Cost.....	41
Estimating Application and Removal Costs.....	43
MODEL OPERATION.....	45
Input .....	45
Evaluation.....	46

Calculating Equivalent Cost Factors .....	54
RESULTS AND ANALYSES.....	55
Analysis 1: Yellow Edge Line on Concrete Pavement Applied in Daytime Off-Peak.....	55
Analysis 2: Daytime vs. Nighttime Application .....	56
Analysis 3: Concrete Pavement vs. Asphalt Pavement.....	57
Analysis 4: Different Pavement Remaining Service Lives: 100 vs. 10 Months .....	58
Analysis 5: Comparing the Method of This Study with the Kansas Method.....	59
RAISING CURRENT RETROREFLECTIVITY REQUIREMENTS .....	63
Specifications for 90 Mil Thermoplastics .....	64
Specifications for White Tape.....	69
CONCLUSIONS.....	73
POTENTIAL PROBLEMS AND RECOMMENDATIONS FOR FUTURE RESEARCH.	75
REFERENCES .....	77

## LIST OF FIGURES

Figure 1 30-Meter geometry measurement of retroreflectivity [11] .....	5
Figure 2 Laserlux (left) and LTL2000 (right) [12].....	6
Figure 3 Profiled pavement marking [12] .....	10
Figure 4 Inverted profile line striping system [23].....	11
Figure 5 Service life of durable pavement markings in months .....	13
Figure 6 Observed retroreflectivity patterns over time [22].....	14
Figure 7 Life expectancy of preformed tape on both AC and PCC.....	16
Figure 8 Service lives and ADT/lane for epoxy on PCC and AC [28] .....	17
Figure 9 Applying the lines [35] .....	20
Figure 10 Retroreflectivity data from NTPEP Web site for a tape marking product .....	21
Figure 11 Measuring user benefit: Kansas and Virginia .....	23
Figure 12 Pavement marking retroreflectivity and public perception of its brightness.....	24
Figure 13 ADT distribution of Louisiana Interstate and retroreflectivity reading sites .....	30
Figure 14 Retroreflectivity as a function of time for a marking material.....	31
Figure 15 Measure benefit based on user perception.....	33
Figure 16 User cost by number of lanes and time of operation .....	42
Figure 17 Application cost of a 90 mil marking material by job size.....	43
Figure 18 Removal cost of all materials by job size.....	44
Figure 19 User interface after launching the program.....	48
Figure 20 Result of analysis: benefit/cost ratio by ADT .....	50
Figure 21 Application, removal, and user delay costs.....	51
Figure 22 Estimated benefit and pavement marking service life.....	52
Figure 23 Result of analysis: user input data.....	53
Figure 24 Output of equivalent cost factor program.....	54
Figure 25 Benefit/cost ratios for a yellow edge line.....	55
Figure 26 Benefit of a yellow edge line by ADT.....	56
Figure 27 Application, removal, and user costs of a yellow edge line .....	56
Figure 28 Benefit/cost ratios for daytime off-peak and nighttime restripes .....	57
Figure 29 User delay costs for daytime off-peak and nighttime applications .....	57
Figure 30 Benefit/cost ratios for a white lane line on PCC and AC.....	58
Figure 31 B/C ratios for white lane lines with different remaining pavement service life....	59
Figure 32 Expected marking service lives for different materials.....	59
Figure 33 Comparison between the method used in this study and the Kansas method .....	60
Figure 34 Different methods of calculating benefits .....	60
Figure 35 Retroreflectivity for two 90 mil thermoplastic products from NTPEP .....	63
Figure 36 Average Louisiana white 90 mil materials meet the new requirements.....	66
Figure 37 Average Louisiana yellow 90 mil materials meet the new requirements.....	66
Figure 38 Potential service life increases by raising initial retroreflectivity for white 90 mil	67

Figure 39 Potential service life increases by raising initial retroreflectivity requirements ....	68
Figure 40 Percent 90 mil materials failing different initial retroreflectivity requirements.....	68
Figure 41 Average Louisiana tape materials vs. the requirements .....	70
Figure 42 Potential gain in service life for white tape .....	71
Figure 43 Percent white tape failure at different initial retroreflectivity requirements .....	72



## LIST OF TABLES

Table 1 Minimum retroreflectivity guidelines from FHWA [2] .....	7
Table 2 Marking materials used by state DOTs and local authorities [2] .....	8
Table 3 Typical marking materials used in the United States [17] .....	8
Table 4 North Dakota pavement marking selection matrix [24] .....	12
Table 5 KDOT BBF factor for a pavement with five years of remaining service life .....	13
Table 6 Total cost (\$/mile) of pavement marking materials for different study periods .....	22
Table 7 VDOT estimated cost of delay by scenario [37] .....	25
Table 8 Data availability .....	30
Table 9 Estimated model by material, line color, and pavement surface type .....	39
Table 10 Observed vs. model predicted pavement marking service life .....	40
Table 11 Parameter values used to calculate user cost due to lane closure .....	41
Table 12 Regression models for calculating user cost.....	43
Table 13 Average application and removal costs .....	44
Table 14 Current specifications on marking retroreflectivity (mcd/m <sup>2</sup> /lux).....	63
Table 15 Suggested retroreflectivity specifications for 90 mil thermoplastics.....	65
Table 16 Average 90 mil retroreflectivity models as a function of month.....	65
Table 17 Suggested retroreflectivity specifications for white tape.....	70



## INTRODUCTION

Pavement markings are an essential component of the highway system. They provide guidance and convey regulations and warnings to road users. Pavement markings include longitudinal lines, transverse lines, words, and symbols. Longitudinal markings include centerlines, lane lines, and edge lines on paved streets and highways. White and yellow are the two most commonly used colors for pavement markings. White lines are used to separate traffic flows in the same direction and delineate the right edge of the roadway; yellow lines are used to separate traffic in opposing directions, two-way, left-turn lanes, and reversible lanes from other lanes and delineate the left edge of the roadway of divided and one-way highways and ramps [1]. Most pavement markings are retroreflective; that is, they have the ability to redirect light beams from vehicle headlights back in the direction of the driver. This retroreflective property of the pavement markings is essential for efficient and safe vehicle operations at night. Retroreflectivity is achieved by embedding tiny glass beads in the marking materials.

To maintain retroreflectivity, pavement markings need to be restriped periodically. According to a recent study on long-term pavement marking practice in the U.S., the annual budget for pavement markings in a typical state is \$12.6 million [2]. In 2000, Louisiana spent \$7.5 million on 16,681 centerline miles of highway for pavement marking [2]. For the interstate highways alone, Louisiana has to maintain adequate levels of retroreflectivity for about 800 center line miles of pavement markings. The pavement materials that have been used on the Louisiana Interstate system include thermoplastics (both 40 and 90 mil), preformed tape, and inverted profile markings. These materials have been used under a variety of conditions, including different traffic levels, different pavement surface types, different line types, and different line colors. Two questions that have arisen among those seeking the most efficient application of resources are: “Are we applying the best pavement marking material in each application given the different conditions encountered on Louisiana roads?” and “What improvement in performance could be expected if specifications of the material are made more stringent?” This study aims to answer these questions.



## OBJECTIVES

The objectives of this study are to:

1. Determine which pavement marking material is the best for the interstate highways in Louisiana for:
  - yellow edge line,
  - white edge line, and
  - white lane line

given the following conditions:

- remaining pavement life,
  - minimum threshold retroreflectivity,
  - retroreflectivity above which driver satisfaction is not improved,
  - pavement surface type,
  - daytime/nighttime application, and
  - cost.
2. Estimate the benefit of increasing the starting and six-month retroreflectivity specifications of pavement marking materials.



## LITERATURE REVIEW

A comprehensive literature review on pavement marking materials and the economic evaluation of their provision is presented below. The review concentrates on recent literature (i.e., since 1990) because of the rapid development of pavement marking materials and technology during that period. However, some earlier work has been reviewed with respect to methodology.

### Retroreflectivity and Its Measurement

Retroreflectivity is measured by retroreflectometers in units of millicandelas per square meter per lux ( $\text{mcd}/\text{m}^2/\text{lux}$ ). This measures the intensity of reflected light per lux (one meter-candle or illumination provided by one standard candle at a distance of one meter) of light source. The American Society for Testing of Materials (ASTM) adopted the European Committee for Standardization (CEN) 30-m (98.4-ft) geometry for measuring pavement marking retroreflectivity. The 30-m geometry means that retroreflectivity is measured as if a driver views the marking 30-m ahead of the vehicle, as shown in figure 1. Measuring at greater distances establishes a measurement problem due to the flat angle of measurement. Non-standard instruments use 12-m or 15-m geometry. Instruments of different geometry do not correlate well, especially around the critical retroreflective value of  $100 \text{ mcd}/\text{m}^2/\text{lux}$  [3]. However, 30-m instruments are more comparable, with measurements within an eight percent range of the mean retroreflectivity values [4], [5], [6], [7], [8], [9], [10].

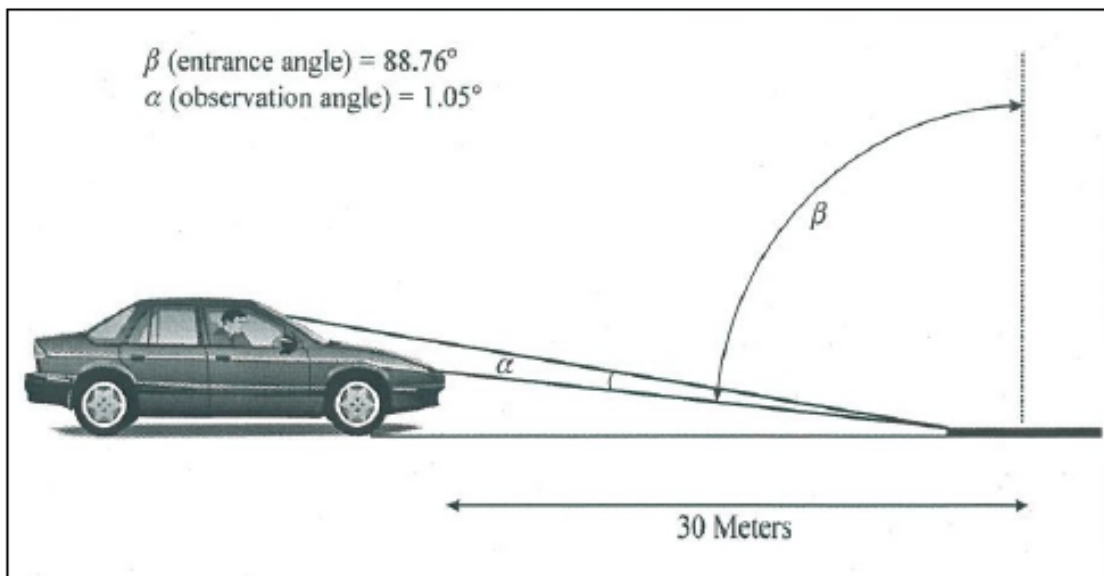

**Figure 1**  
**30-Meter geometry measurement of retroreflectivity [11]**

Retroreflectometers can be either hand-held or mobile. Hand-held instruments are cheaper but require more crew members to cover the same mileage. In contrast, mobile instruments require only a single crew member, and readings are taken at driving speed. According to a study by the University Transportation Center in Alabama [12], in which they compared the cost of a hand-held (LTL2000) and a mobile (Laserlux) retroreflectometer, the more miles of pavement marking strip measured per year, the more cost efficient the Laserlux equipment becomes. The break-point at which the Laserlux becomes less costly is approximately 580 miles of two-lane road system per year. Figure 2 presents pictures of the two types of retroreflectometers used in the study.



**Figure 2**  
**Laserlux (left) and LTL2000 (right) [12]**

### **Minimum Retroreflectivity Standard**

The Federal Highway Administration (FHWA) was required to revise the Manual on Uniform Traffic Control Devices (MUTCD) to specify minimum retroreflectivity values for the pavement marking standard. FHWA has developed candidate criteria for minimum pavement marking retroreflectivity [13]. However, they are yet to be approved as standards. These recommended guidelines are impacted by three factors: speed, roadway type, and the presence/absence of raised reflective pavement markers (RRPM) or lighting, as presented in table 1.

For freeways, minimum guideline retroreflectivity values of 150 mcd/m<sup>2</sup>/lux and 100 mcd/m<sup>2</sup>/lux are recommended for white and yellow pavement markings, respectively, when there is no RRPM or lighting; while 70 mcd/m<sup>2</sup>/lux is used for both white and yellow pavement markings when there is RRPM or lighting. There are two reasons for the lower



value for yellow markings. First, the retroreflectivity of yellow markings is 35% lower than that of white markings [14]. Second, white and yellow markings are usually replaced at the same time [13]. A more recent FHWA study [15] recommended 40 mcd/m<sup>2</sup>/lux for fully marked roadways and 50 mcd/m<sup>2</sup>/lux for roadways with center lines only in the presence of RRPMs.

**Table 1**  
**Minimum retroreflectivity guidelines from FHWA [2]**

Material	Roadway type/speed classification		
	Non-freeway ≤ 40 mph	Non-freeway ≥ 45 mph	Freeway ≥ 55 mph
White	85	100	150
White with lighting or RRPM	30	35	70
Yellow	55	65	100
Yellow with lighting or RRPM	30	35	70

Some states have conducted their own research and established their own guidelines. For example, a Minnesota DOT study recommended using 120 mcd/m<sup>2</sup>/lux as the minimum retroreflectivity value for both white and yellow lines [16]; Louisiana uses 100 mcd/m<sup>2</sup>/lux for both white and yellow lines on interstate highways.

### Pavement Marking Materials

There are several pavement marking materials available for commercial use. NCHRP Synthesis 306 [2] listed 16 for longitudinal markings based on the survey from different state departments of transportation (DOTs) and local authorities. They are presented in table 2.

Some materials are used more frequently than others. Waterborne paint is the most common material. It is used by 78 percent of the responding agencies, followed by thermoplastic (69 percent). Table 3 shows the materials commonly used nationwide and the percent usage by lane miles and expenditure [17]. Paint, epoxy, thermoplastics, and tape are the most commonly used pavement marking materials, and they account for more than 90 percent of lane miles and expenditure. Their characteristics are discussed below.

#### Paint

There are two kinds of conventional paints: solvent-based and waterborne paints. Solvent-based paints are being replaced by waterborne paints in most states because solvent-based

paints contain volatile organic compounds (VOCs) that are not environmentally friendly [2]. Paints have the cheapest installation cost, with typical values between \$0.03 and \$0.05 per linear foot based on a four-inch wide longitudinal strip [18]. However, their service life is also short, ranging between three and thirty-six months. Initial retroreflectivity values are approximately 275 mcd/m<sup>2</sup>/lux for white and 180 mcd/m<sup>2</sup>/lux for yellow [19]. They are considered best suited to low volume roads.

**Table 2**  
**Marking materials used by state DOTs and local authorities [2]**

Types of markings	Transportation Agencies Reporting Using the Marking Material									
	Total		State		Canadian		County		City	
	(51) <sup>a</sup>	% <sup>b</sup>	(37) <sup>a</sup>	% <sup>b</sup>	(5) <sup>a</sup>	% <sup>b</sup>	(5) <sup>a</sup>	% <sup>b</sup>	(4) <sup>a</sup>	% <sup>b</sup>
<b>Longitudinal Markings</b>										
Waterborne paints	40	78	33	89			5	100	2	50
Thermoplastic	35	69	30	81			3	60	2	50
Preformed tape - flat	22	43	19	51			2	40	1	25
Preformed tape - profiled	21	41	20	54					1	25
Epoxy	20	39	19	51			1	20		
Conventional solvent paint	20	39	13	35	5	100	1	20	1	25
Methyl methacrylate	10	20	9	24			1	20		
Thermoplastic - profiled	9	18	9	24						
Polyester	5	10	5	14						
Polyurea	2	4	2	5						
Cold applied plastic	1	2	1	3						
Experimental	1	2	1	3						
Green lite powder	1	2	1	3						
Polyester – profiled	1	2	1	3						
Tape (removable)	1	2	1	3						
HD-21	1	2					1	20		

<sup>a</sup>Number of transportation agencies responding to the survey.

<sup>b</sup>Percentage of the responding agencies that reported using the marking material; e.g., 78% (40/51) use waterborne paint.

**Table 3**  
**Typical marking materials used in the United States [17]**

Pavement Marking material	Percent of Lane Miles	Percent of Expenditure
Conventional Paint	58	17
Thermoplastics	21	34
Epoxy	6	7
Tape	5	26
Polyester	2	2
Profiled Thermoplastics	2	7
Other	6	7

## **Epoxy**

Epoxy is a mixture of two components that react chemically in a heat-releasing reaction to form a solid adhesive [18]. Epoxy is significantly more expensive than conventional paints. However, it offers longer life and a higher level of retroreflectivity, with typically installed costs ranging between \$0.20 and \$0.30 per linear foot based on a four-inch wide longitudinal strip. Its service life ranges from two to four years, depending on the traffic volume [18]. Initial retroreflectivity values are approximately 300 mcd/m<sup>2</sup>/lux for white and 180 mcd/m<sup>2</sup>/lux for yellow [19].

## **Thermoplastic**

Thermoplastic is a blend of solid ingredients (resin, pigments, and fillers) that becomes liquid when heated and returns to a solid state on cooling. Thermoplastics are classified into two types: hydrocarbon-based plastics derived from petroleum, and alkyd, which is a naturally occurring resin [2]. Thermoplastics are expensive in comparison to conventional paints, with installed costs ranging between \$0.19 and \$0.26 per linear foot based on a four-inch wide longitudinal strip [20]. Service life is between four and seven years but it varies widely depending on installation procedures, traffic volume, atmospheric conditions when placed, and snowplow activity. Thermoplastics can be applied to the roadway surface by spraying or extrusion. Extruded thermoplastics are thicker than sprayed thermoplastics. Varied results have been obtained applying thermoplastics on Portland cement concrete (PCC). Some states have had great success, while many others have discontinued its use on PCC [21], [22].

## **Tape**

Preformed tapes are made of preformed thermoplastics that are glued to the pavement surface, including flat preformed and profiled preformed tapes. Tapes are very expensive but very durable. Typical installation costs are between \$1.50 to \$2.65 per linear foot [19]. The service life is roughly four to eight years [18]. They are often used in high traffic areas. Initial retroreflectivity values are approximately 1100 mcd/m<sup>2</sup>/lux for white and 800 mcd/m<sup>2</sup>/lux for yellow [20].

## **Profiled Pavement Markings**

Profiled pavement markings (PPMs) have been used to enhance visibility under wet conditions at night and have become popular in southern states where snowplows are not used [21]. Most PPMs are constructed using thermoplastics. Figure 3 gives an example of a PPM.



**Figure 3**  
**Profiled pavement marking [12]**

According to Gates et al. [21], there are two popular application methods. One is inverted profile marking created by rolling a cog over fresh wet marking material, as demonstrated in Figure 4. Inverted profile pavement marking has been used in Louisiana. The other is raised profile marking created by extruding a marking of normal thickness with a raised part at uniform spacing.

Lindly et al. [12] evaluated flat thermoplastic markings (FTMs) and PPMs installed on highways maintained by Alabama DOT. Service life, life cycle costs, crash rates, and wet-night retroreflectivity were compared. They found that new FTMs have higher average dry retroreflectivity than PPMs, and both decay at similar rates with respect to cumulative traffic passages (CTP). As a result, FTMs consistently provide higher dry retroreflectivity than PPMs under similar ADT levels. On average, FTMs last at least six months longer than PPMs. Nonetheless, PPMs do provide higher wet retroreflectivity than FTMs, with average wet retroreflectivity values of PPMs at end of their service life being as high as that of FTMs at the beginning of their life. However, Lindly et al. found no evidence that the higher retroreflectivity of PPMs resulted in a lower crash rate than with FTMs. The life cycle cost of FTMs is much smaller than PPMs. Overall, the study found that economics, marking service life, and crash data do not justify widespread use of PPMs in preference to FTMs.

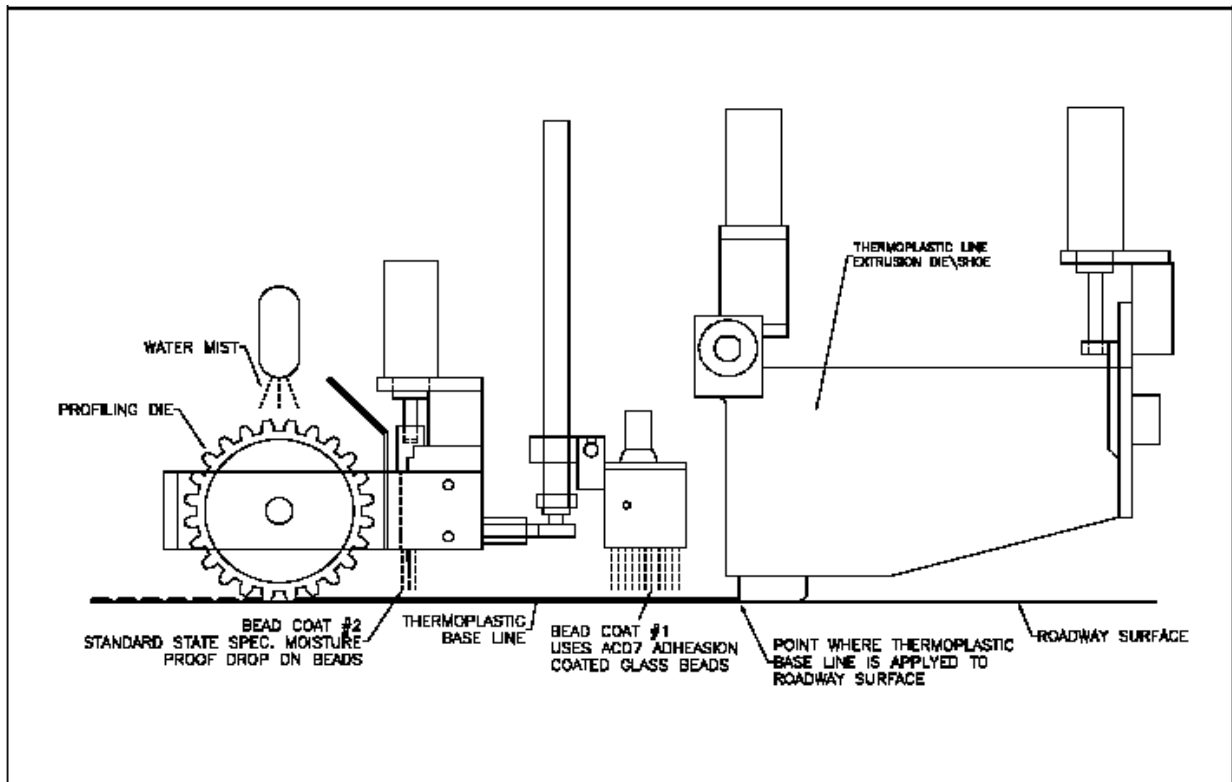

**Figure 4**  
**Inverted profile line striping system [23]**

### State Practices on Pavement Marking Material Selection

State DOTs have developed their own criteria for selecting pavement marking materials. According to a recent survey [2], eight states have published one-page pavement marking material selection guidelines. Most common factors considered by the states include type of line (center, lane, or edge line), pavement surface (asphalt concrete (AC) or PCC), type of road (such as interstate, multilane, or two-lane highways, etc.), and average daily traffic (ADT). Some states, such as Kansas, Washington, and North Dakota, also take into consideration pavement condition or remaining pavement service life. Table 4 presents North Dakota's pavement marking selection matrix [24]. Pavement condition is classified into new, good, and fair/poor according to its pavement management system; traffic volume is classified into four groups with dividing values of 2,000, 4,000, and 10,000 vehicles per day (vpd). Depending on the line type and pavement surface type, different marking materials are recommended.

**Table 4**  
**North Dakota pavement marking selection matrix [24]**

Road Characteristics		AADT >10,000			AADT 4,000 – 10,000			AADT 2000 – 4,000			AADT <2,000
Type	Condition	Center/Skip	Edge	Misc.	Center/Skip	Edge	Misc.	Center/Skip	Edge	Misc.	All
Asphalt	New	Inlaid Patterned Pre-formed Plastic	Inlaid Patterned Pre-formed Plastic	Paint	Inlaid Patterned Pre-formed Plastic	Paint	Paint	Paint	Paint	Paint	Paint
	Good*	Inlaid Patterned Pre-formed Plastic	---	---	Inlaid Patterned Pre-formed Plastic	Paint	Paint	Paint	Paint	Paint	Paint
	Fair/Poor*	Paint	Paint	Paint	Paint	Paint	Paint	Paint	Paint	Paint	Paint
Concrete	New	Grooved Patterned Pre-formed Plastic	Grooved Patterned Pre-formed Plastic	---	Grooved Patterned Pre-formed Plastic	---	---	Grooved Patterned Pre-formed Plastic	Paint	Paint	Paint
	Good*	Grooved Patterned Pre-formed Plastic	Paint	Paint	Grooved Patterned Pre-formed Plastic	Paint	Paint	Paint	Paint	Paint	Paint
	Fair/Poor*	Paint	Paint	Paint	Paint	Paint	Paint	Paint	Paint	Paint	Paint

\* Use the Pavement Management System to determine road surface condition

Kansas DOT (KDOT) developed a sophisticated methodology to determine the most economical type of pavement marking to be used under different conditions [25]. Materials are selected based on the remaining pavement service life (between 1 and 7 years), ADT level (<5,000, 5,000-50,000, and >50,000 vpd), and a Brightness Benefit Factor (BBF). The BBF is a benefit/cost ratio representing the combined effects of a material's retroreflectivity, durability, and installed cost. The BBF is defined as:

$$BBF = R_a T_s / S \quad (1)$$

where:

$R_a$  = average useful retroreflectivity over the anticipated service life of the project in mcd/m<sup>2</sup>/lux.

$T_s$  = pavement marking service life in years, and

$S$  = average cost per unit length in dollars per meter.

Table 5 shows a sample application of the Kansas method for a pavement with five remaining years of service life. The materials with the highest BBF values are highlighted in the table based on ADT values. For example, if ADT is <5,000 vpd, then modified urethane has the highest BBF value and is selected; if 5000<=ADT <=50,000 vpd, or ADT > 50,000 vpd, then thermoplastic is selected, provided the surface is not PCC.

**Table 5**

**KDOT BBF factor for a pavement with five years of remaining service life**

Material Type	Brightness Benefit Factor for ADT of:		
	<5000	5000-50000	>50000
Patterned Cold Plastic	201	326	273
Thermoplastic*	717	593	587
Spray Thermoplastic*	357	0	0
Epoxy	752	399	250
KDOT Paint (HD-21)	369	343	310
Modified Urethane	787	508	485
Cementitious	115	112	99
PCP CL & Epoxy EL	691	391	252

\*Not to be used on concrete surface.

**Pavement Marking Service Life and Its Modeling**

**Pavement Marking Service Life**

The service life of a longitudinal pavement marking is the time or number of traffic passages needed for its retroreflectivity to decrease from the initial value to a minimum threshold value under which the marking needs to be refurbished or replaced [26]. It is a function of the pavement marking material, pavement surface type, type and color of line, traffic volume, the climate, and the quality control when the markings are applied. Dale [27] found that the increased speed and truck load can also reduce the service life.

Pavement marking service lives vary by color and pavement surface type. Figure 5 presents the service life of durable longitudinal pavement markings by color of line and type of pavement surface type at a threshold value of 100 mcd/m<sup>2</sup>/lux [3].

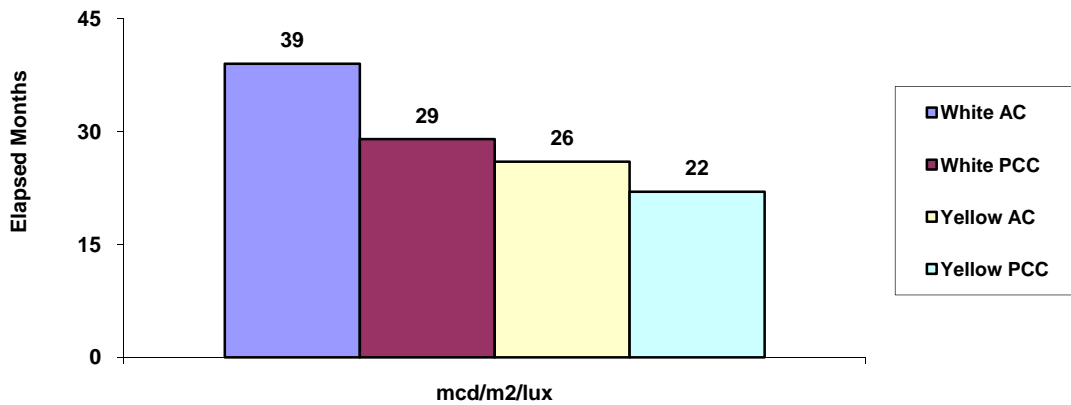
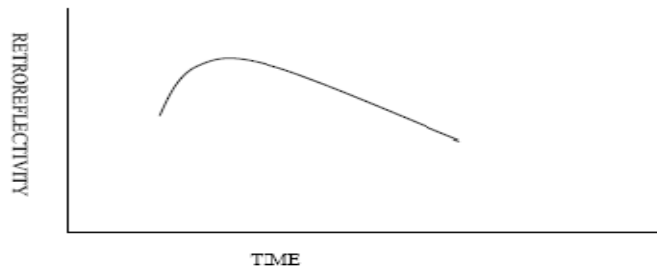

**Figure 5**

**Service life of durable pavement markings in months**

AC pavements have longer service lives than PCC pavements, and white lines have longer service lives than yellow lines. However, Dale [27] found that epoxy and tape have the same service life on both AC and PCC. A study by Perrin et al. [28] indicated that the service lives of both paint and epoxy are greater on PCC than on AC.

Thamizharasan et al. [22] identified four patterns of retroreflectivity change over time, and they are presented in figure 6. The first pattern is where retroreflectivity increases for a short period of time, then gradually decreases thereafter (figure 6a). This is for the newly placed markings. The initial increase in retroreflectivity is because of the glass beads becoming exposed after some amount of wear. The second pattern is where retroreflectivity decreases gradually with time in almost a straight line. This is for the well-established markings that have passed the initial increase period (figure 6b). The third pattern depicts the impact of remarking and the fourth the impact of snowplowing (figure 6c).



(a) Pattern representative of newly placed pavement markings

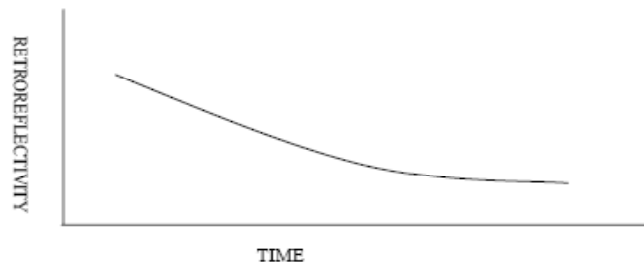

(b) Pattern for established sites – markings older than about 300 days

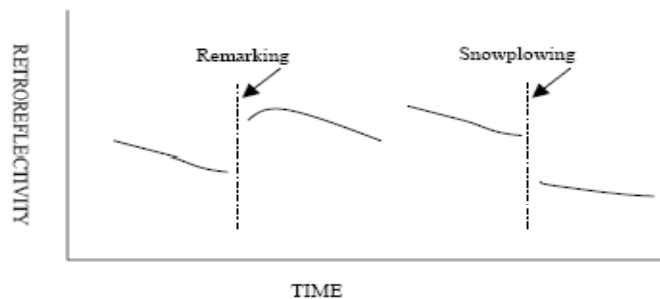

(c) Patterns showing sudden change due to maintenance operations

**Figure 6**  
**Observed retroreflectivity patterns over time [22]**



### Pavement Marking Service Life Modeling

Time has been considered the most important variable in modeling pavement marking service life by many studies. Andrady et al. [29] used the following equation to describe the retroreflectivity-service life relationship:

$$T_{100} = 10^{(R_0 - 100)/b} \quad (2)$$

where

$T_{100}$  = duration in months for retroreflectivity to reach a value of 100 mcd/m<sup>2</sup>/lux,

$R_0$  = estimate of the initial retroreflectivity value, and

$b$  = gradient of the semi-logarithmic plot of retroreflectivity.

Lee et al. [30] developed the following linear regression model for thermoplastic markings:

$$Y = -0.3622X + 254.82, \quad (3)$$

where

$Y$  = retroreflectivity of pavement markings (mcd/m<sup>2</sup>/lux), and

$X$  = age of marking in days.

Thamizharasan et al. [22] developed two models to predict marking retroreflectivity, including a non-linear model for the time the retroreflectivity increases when newly applied and a linear model for the time retroreflectivity decreases to a minimum value. The models were stratified by marking color (white or yellow), surface type (AC or PCC), and marking material (thermoplastic or epoxy). ADT was found not to be significant in the analysis. An example of Thamizharasan et al.'s model:

$$\text{Difference in Retroreflectivity} = -0.06\text{Days} - 6.80. \quad (4)$$

Bahar et al. [31] used the following inverse polynomial model to estimate the retroreflectivity as a function of age:

$$R = \frac{1}{\beta_0 + \beta_1 * \text{Age} + \beta_2 * \text{Age}^2}, \quad (5)$$

where

$R$  = retroreflectivity of pavement markings (mcd/m<sup>2</sup>/lux),

$\text{Age}$  = age of marking in months, and

$\beta_0, \beta_1, \beta_2$  = model parameters to be estimated.

Other variables considered by Bahar et al. included color, material, traffic volume, pavement surface type, climatic region, and snow removal. ADT has inconsistent effects across different material types, and for some materials, the effects are unexplained. As a result, ADT was not used in the models. Different models were estimated based on the combination of the rest of the variables.

Lindly et al. [12] tried to estimate a model that included both time and ADT. The model was found not to be statistically significant and was discarded. However, that traffic volume adversely impacts the service life of pavement markings is well known. A model of service life without traffic as a variable seems counter-intuitive, although one may argue that the impact of traffic is implicitly included in time. Dale [27] found a linear relationship between service life and ADT. Figure 7 presents an example of his findings for a preformed tape by degree of snowfall. As ADT increases, the service life decreases in a linear fashion; as snow fall increases, the service life decreases.

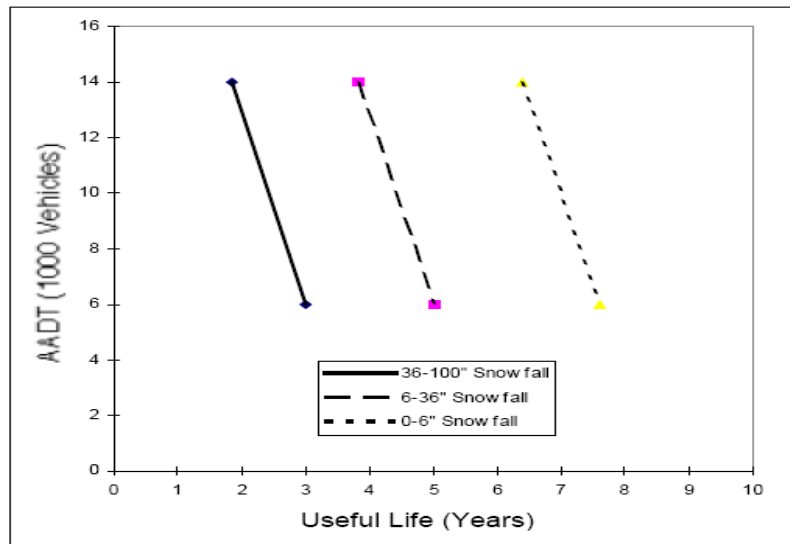

**Figure 7**  
**Life expectancy of preformed tape on both AC and PCC**

Using data from Utah, Perrin et al. [28] found that the relationship between service life and ADT is a hyperbolic curve, and the product of ADT and service life is a constant. Figure 8 gives a graphic representation of the relationship for epoxy by surface type and compares Perrin et al.'s model with that of Dale's. The relationship is shown in the following equation:

$$U = \frac{K}{V}, \quad (6)$$

where

U = useful life (months),

V = ADT/lane, and

K is a constant defined as:

$$K = \frac{I-M}{D}, \quad (7)$$

where

I = initial retroreflectivity (mcd/m<sup>2</sup>/lux),

M = minimum acceptable retroreflectivity (mcd/m<sup>2</sup>/lux), and

D = average deterioration rate (mcd/m<sup>2</sup>/lux/month/ADT/lane).

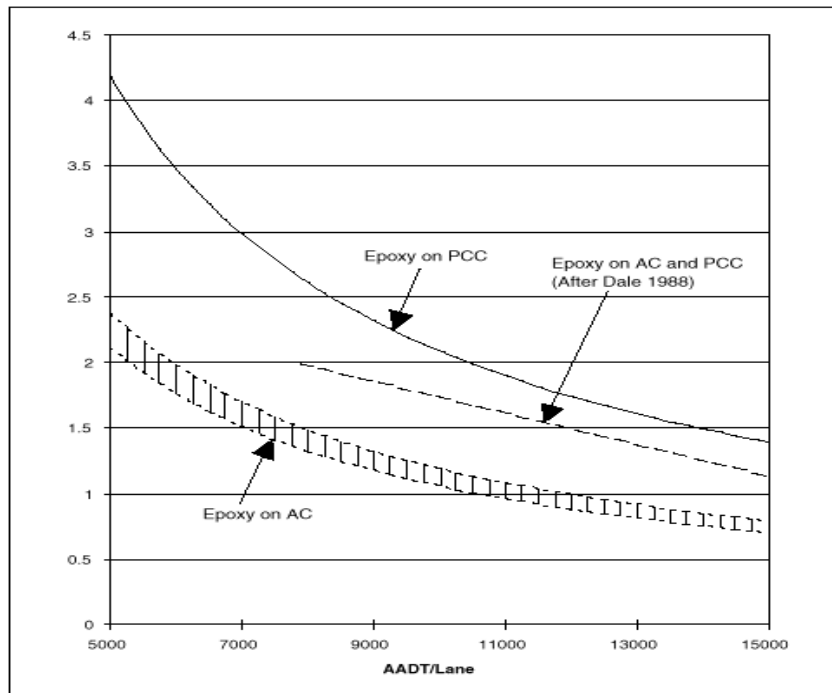

**Figure 8**

**Service lives and ADT/lane for epoxy on PCC and AC [28]**

Many recent studies use the product of time and ADT to form a new variable to represent the combined impact of both. This variable, the cumulative number of traffic passages (CTP) is typically expressed in terms of millions of vehicle passages per lane. For example, the CTP of a lane is given by:

$$CTP = \frac{ADT * \text{age of marking in months} * 30}{1,000,000 * \text{number of lanes}} \quad (8)$$

CTP represents the cumulative exposure of the marking to vehicle travel since its installation.

Since CTP is derived from marking age and ADT, CTP and marking age are correlated. To find out which of the two should be used as the primary variable in the model, Lindly et al. [12] tested different regression model forms, including linear, exponential, logarithmic, and power forms. The coefficient of determination ( $R^2$ ) was used as the primary criterion in identifying the best model. They found that CTP had a better correlation with retroreflectivity than marking age. Secondary variables, such as road type, speed limit, marking width, geographic location, roadside development, etc., were also investigated, and none were statistically significant. Lindly et al. found linear and exponential models have similar  $R^2$  values that are better than those achieved with logarithmic and power models. These two model forms are:

linear model

$$R_l = a + b * CTP \text{ and} \tag{9}$$

exponential model

$$R_l = a * \exp (b * CTP) , \tag{10}$$

where  $R_l$  is the pavement marking retroreflectivity and  $a$  and  $b$  are model coefficients.

Using CTP as the primary variable, Magletz et al. [26] tested different model forms, including linear, quadratic, and exponential regressions. Abboud and Bowman [32] employed linear and log-linear regressions. When CTP is estimated, it is common practice to translate the result into service life until the minimum retroreflectivity is reached. That is, the model is used to estimate the CTP values corresponding to the minimum retroreflectivity, and then equation 8 is applied to find the service life in months after converting from the service life in days. Alternatively, the following equation can be used [2]:

$$SL_{months} = \frac{SL_{CTP}}{\left[ \frac{CTP_{final}}{Date_{final} - Date_{install}} \right] \left[ \frac{365.25 \text{ days}}{12 \text{ months}} \right]} \tag{11}$$

where

$SL_{months}$  = service life in elapsed months;

- $SL_{CTP}$  = service life in cumulative traffic passages (millions of vehicles), corresponding to CTP values when  $R_1$  equals to the minimum retroreflectivity;
- $CTP_{final}$  = cumulative traffic passages (millions of vehicles) at final field measurement date;
- $Date_{final}$  = date of final field measurement; and
- $Date_{install}$  = installation date of pavement marking.

Service life is usually calculated according to road ADT at different levels. Lindly et al. [12] used 2,500, 5,000, 7,500, and 10,000 vpd per lane, while Abboud and Bowman [32], [33] used low-ADT (<2,500 vpd), mid-ADT (2,500 to 5,000 vpd), and high-ADT (>5,000 vpd) in their calculations. For calculating BBF, Kansas DOT used <5,000 vpd, 5,000-50,000 vpd, and >50,000 vpd [25].

### **The National Transportation Product Evaluation Program**

Founded in 1994, the National Transportation Product Evaluation Program (NTPEP) is operated by the American Association of State Highway and Transportation Officials (AASHTO) to provide engineering and technical services to state DOTs to prequalify transportation products with reduced duplication of effort by state DOTs and industrial participants. A wide variety of products are tested, including pavement marking materials. Many states indicated their intention to make greater use of the NTPEP test results, while others continue to conduct their own product tests [2].

NTPEP pavement marking materials are tested on selected test decks throughout the country under various temperatures, humidity, and other geographical conditions. The recent NTPEP test decks include [34]

- “cold, dry, altitude” region: 1997 Minnesota, 1999 Wisconsin;
- “cold, humid, altitude” region: 1996, 1998, 2000, 2002 Pennsylvania;
- “cold/warm, humid” region: 1996 Kentucky;
- “hot, humid, gulf state” region: 1996, 1998 Texas; 1999, 2002 Mississippi; 1997 Alabama;
- “warm, wet, high ADT, urban” region: 2000 California; and
- “warm, wet, altitude, studded tires” region: 1995 Oregon.

The ASTM D713-“Standard Practice for Conducting Road Service Tests on Fluid Traffic Marking Materials” specifies the requirements for test site selection, which include the use of

four-lane divided highways; ADT greater than 5,000 vpd; and free rolling conditions for vehicles, and hence, no grades, curves, or intersections, etc., at the location of testing. For the liquid thermoplastic and preformed tape materials, four lines are laid next to each other for each sample. The test lines are transverse lines running from the right edge line to the skip line area. Figure 9 presents an example of placement.



**Figure 9**  
**Applying the lines [35]**

Among the data collected is the marking retroreflectivity. The retroreflectivity data are obtained with the LTL 2000 Retroreflectometer (30-meter geometry) according to ASTM D-713. Field observations are made within seven days of material application and then at monthly intervals during the first year. After the first year, measurements are taken quarterly until the end of the field test, which usually lasts for two years. For each material, the averages of the data taken for the four transverse lines are given. The average measurements in the left wheel path and skip line (lane centerline) area are presented separately. Figure 10 shows an example output for a tape marking material. Data are available from NTPEP Web site at <http://data.ntpep.org/>.

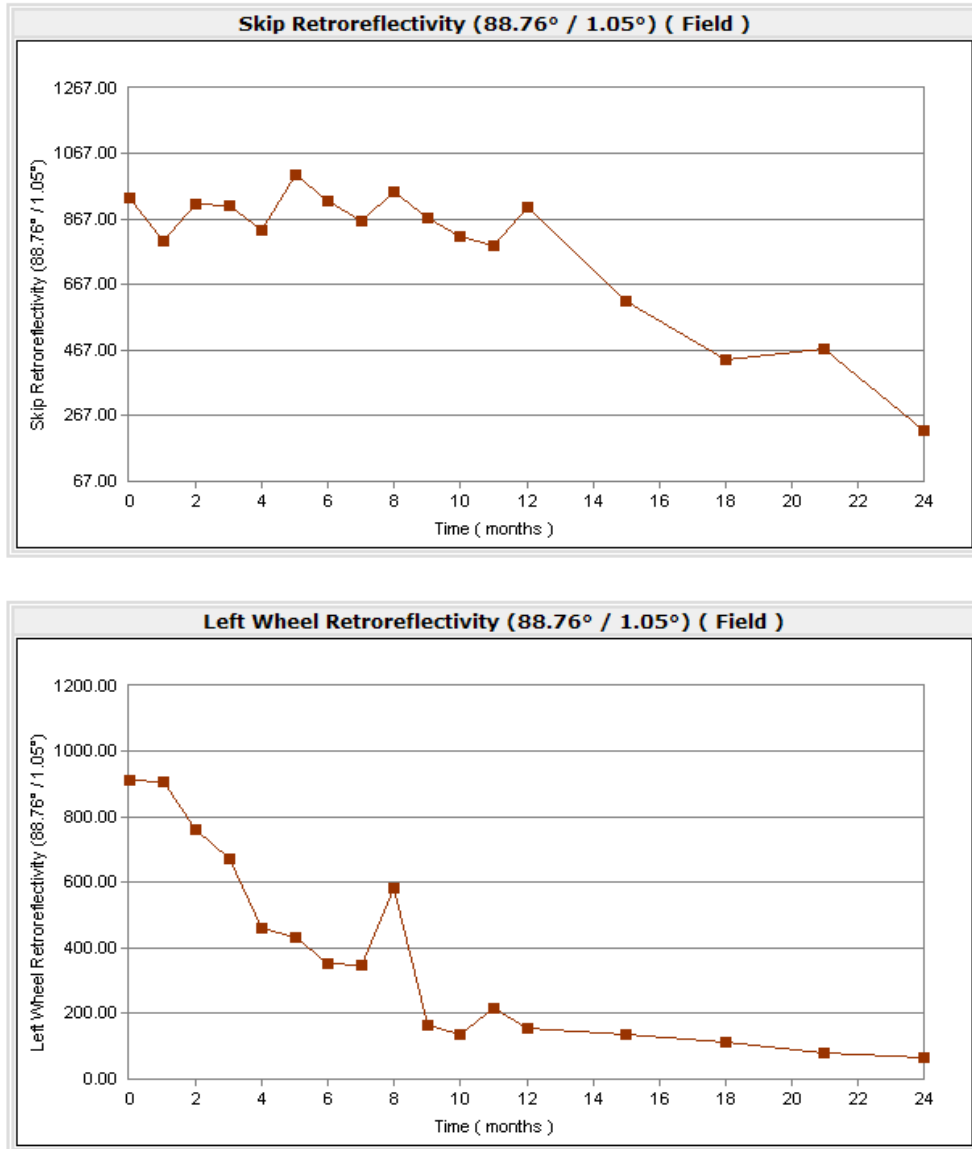

**Figure 10**  
**Retroreflectivity data from NTPEP Web site for a tape marking product**

There are several potential problems regarding applying the NTPEP data in Louisiana. First, the products evaluated by NTPEP may not be representative of the materials actually used in Louisiana. Second, the observation is usually made for the first two years, which is, in most cases, not long enough to observe a decrease in retroreflectivity to critical values around 100 mcd/m<sup>2</sup>/lux. Third, observations are made on a test deck with a relatively stable ADT value during the period of observation, making time the only variable for modeling. Last, there has been no study that demonstrated that either the skip line or left wheel readings resemble the real performance of either lane lines or edge lines.

## Pavement Marking Economic Evaluation

### Methodologies in Pavement Marking Economic Evaluation

The objective of a pavement marking economic evaluation is to identify the most economical pavement marking materials. Three major methods have been employed. Lindly et al. [12] used life cycle cost analysis (LCCA) to compare different marking materials for Alabama DOT. LCCA assumes the alternatives yield the same level of service, provided the retroreflectivity of the pavement markings meets the minimum value requirement [36]. LCCA requires identification of pavement marking service life and total cost and then calculates the net present worth (NPW) or the equivalent uniform annual cost (EUAC). The material with the lowest NPW or EUAC is selected.

KDOT [25] applied benefit-cost analysis. They assume that higher values of retroreflectivity produce higher user benefits and that the total benefit is the total retroreflectivity produced during the service life of the marking material. The BBF is the ratio of the total retroreflectivity and the total cost during the service life. As a result, the material with the highest BBF value is selected (see table 5 as an example).

Cottrell and Hanson [37] used cost-effectiveness analysis to select marking materials for Virginia DOT (VDOT). They found that there is not much benefit in using a marking with a retroreflectivity value greater than 600 mcd/m<sup>2</sup>/lux compared to one with a value of 300 mcd/m<sup>2</sup>/lux. As a result, their study did not use retroreflectivity as a benefit, only service life. The result of their economic analysis is a table of total cost per mile of pavement marking materials for different study periods, as shown in table 6 [37].

**Table 6**  
**Total cost (\$/mile) of pavement marking materials for different study periods**

Marking Material	Service Life	1 Yr	2 Yr	3 Yr	4 Yr	5 Yr	6 Yr
Paint (large contract)	1 yr	472	944	1,416	1,888	2,360	2,832
Paint (large contract)	6 mo	944	1,888	2,832	3,776	4,720	5,664
Paint (VDOT)	1 yr	944	1,888	2,832	3,776	4,720	5,664
Thermoplastic	3 yr	4,131	4,131	4,131	8,262	8,262	8,262
Epoxy	3 yr	4,719	4,719	4,719	9,438	9,438	9,438
Paint (small contract)	1 yr	1,770	3,540	5,310	7,080	8,850	10,620
Paint (VDOT)	6 mo	1,888	3,776	5,664	7,552	9,440	11,328
Polyurea	3 yr	8,259	8,259	8,259	16,518	16,518	16,518
Paint (small contract)	6 mo	3,540	7,080	10,620	14,160	17,700	21,240
Waffle Tape	6 yr	21,240	21,240	21,240	21,240	21,240	21,240



### The Benefit of Pavement Marking Retroreflectivity

The benefit of having pavement markings has been clearly identified. For example, Miller [38] used benefit-cost analysis and found that the benefit of having pavement markings is 60 times the cost. However, there are different opinions on the benefit of different levels of retroreflectivity. KDOT uses BBF to direct their selection of pavement marking materials. In the calculation of BBF, additional retroreflectivity over the minimum required level is considered a benefit to the user. As a result, the higher the retroreflectivity obtained during the material life time, the higher the BBF. The VDOT study [37] only considers pavement marking service life as a benefit, disregarding the retroreflectivity differences when it is above the minimum threshold level. Figure 11 illustrates the two methods. The horizontal axis is time measured by month; the vertical axis is retroreflectivity;  $R_{\min}$  is the minimum retroreflectivity threshold.

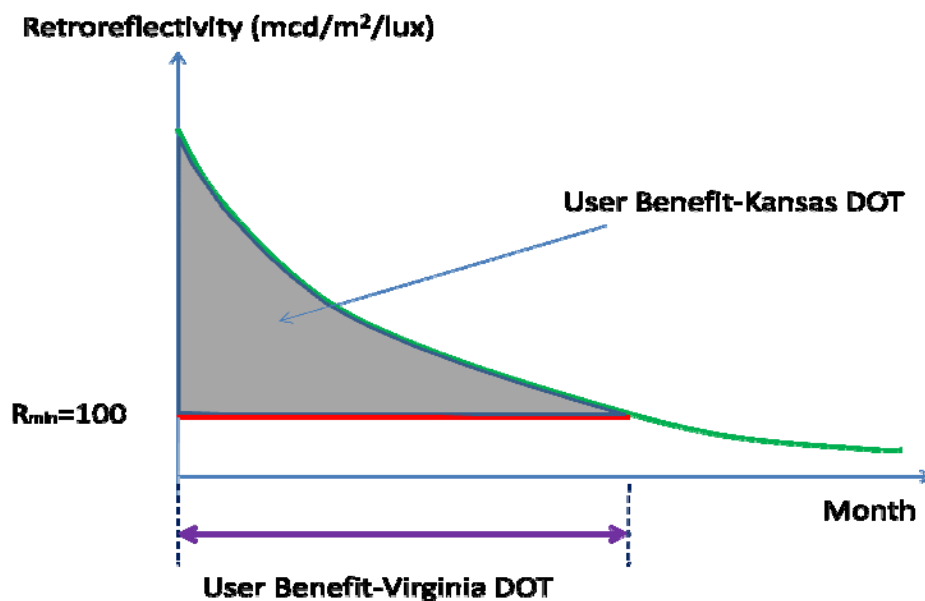

**Figure 11**  
**Measuring user benefit: Kansas and Virginia**

Loetterle et al. [16] studied the public perception of pavement marking brightness. In the study, a total of 194 drivers were asked to grade 18 segments of roadways with different retroreflectivity values. The grading scales were:

- A—Excellent,
- B—Very good,

- C—Acceptable,
- D—Not acceptable, and
- F—Completely unacceptable.

The grading was then transformed into a five-point numeric scale with 5 representing A (excellent), 1 representing F (completely unacceptable), and the others inbetween. A curvilinear regression was estimated to depict the relationship between the retroreflectivity values and the public perception of their brightness, as shown in figure 12 [16].

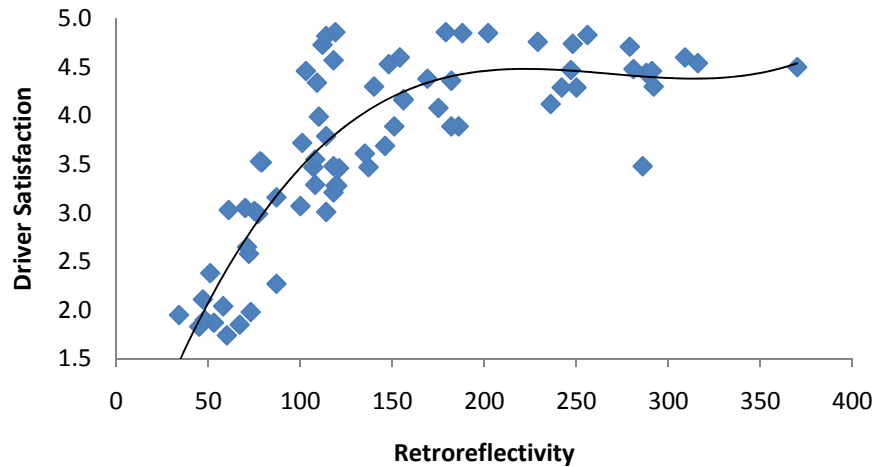

**Figure 12**  
**Pavement marking retroreflectivity and public perception of its brightness**

Loetterle et al. found that the level of satisfaction improves rapidly as the retroreflectivity of the line increases from zero to 120 mcd/m<sup>2</sup>/lux. As the retroreflectivity increases above 120 mcd/m<sup>2</sup>/lux to about 200 mcd/m<sup>2</sup>/lux, there is still an increase in satisfaction, but the rate of increase is less. Above 200 mcd/m<sup>2</sup>/lux, it is not clear that there is any increase in satisfaction. Generally, the threshold value of acceptability versus unacceptability (i.e. where scale values are >3) appears to be between 80 to 120 mcd/m<sup>2</sup>/lux. This result is corroborated by the survey from Cottrell and Hanson [37], which found that there is not much benefit in using a marking with a retroreflectivity value greater than 600 mcd/m<sup>2</sup>/lux compared with a value of 300 mcd/m<sup>2</sup>/lux.

### **Calculating Total Cost**

The components of total cost vary from study to study. In a broad sense, total cost includes installation cost (including application cost and removal cost of old material if needed), user cost due to traffic delay, retroreflectivity measurement cost if any, and safety cost due to pavement marking related accidents. Installation cost per unit length varies greatly according

to the job size. The larger the contract, the lower the installation cost. The number of lanes to be remarked also impacts the cost. KDOT [25] and VDOT [37] included installation and user costs, Utah [39] and Alabama [12] used installation cost only. Abboud and Bowman [33] used installation cost and crash cost to calculate total cost.

**Traffic Delay Cost** Traffic delay due to restriping is a user cost that is to be considered in the calculation of total cost. Cottrell and Hanson [37] used a traffic simulation model (CORSIM) to estimate the vehicle-hours of delay per mile of road by type of road. Such delay is then translated into dollar values by applying the time value of delay. Cottrell and Hanson used the 1999 value of \$16.1 and \$29.42 per hour for cars and trucks respectively and then added the effect of inflation. Table 7 presents the values they used for different scenarios.

**Table 7**  
**VDOT estimated cost of delay by scenario [37]**

Scenario	Delay (veh-hr/mi)	Delay Cost (\$/mi/pass)	Total Delay Cost (\$/mi)
2 lanes 400 vph	3.94	64	193
2 lanes 400 vph 1/2 mi	2.3	38	113
2 lanes 1000 vph	16.3	267	800
2 lanes 1000 vph 1/2 mi	13.7	224	673
2 lanes 2000 vph <sup>†</sup>	35	573	1718
4 lanes 800 vph <sup>†</sup>	0.05	1	2
4 lanes 2000 vph	1.6	26	52
4 lanes 4000 vph	22.5	368	736
6 lanes 1500 vph <sup>†</sup>	0	0	0
6 lanes 3000 vph	0.6	10	29
6 lanes 6000 vph	30.3	496	1488

<sup>†</sup>Not used in further analyses.

FHWA developed a life cycle analysis program called RealCost [40]. One component of the program is to calculate user cost due to lane closure. Seven work zone related user cost components were identified. They are:

- speed change delay,
- speed change vehicle operating cost (VOC),
- reduced speed delay,
- stopping delay,
- stopping VOC,
- queue delay, and
- idling delay.

These user costs can be summarized as user delay and vehicle operating costs. The total cost can be calculated given traffic, roadway, work zone configuration, and time of lane closure conditions.

Louisiana has a similar program named LIFECOST that was developed by Louisiana Department of Transportation and Development's (LADOTD's) Pavement & Geotechnical Services Section [41]. It provides many default values that are suitable for Louisiana.

**Traffic Safety Cost** The cost of traffic safety due to loss of pavement marking retroreflectivity has not been clearly identified until recently. Many believe there is an increased benefit to traffic safety resulting from increased pavement marking retroreflectivity, but only Abboud and Bowman [32], in our literature review, have quantified the safety impact of pavement marking retroreflectivity. However, their estimation of crash cost is problematic because the data they used to estimate crash rates for paint and thermoplastic pavement markings involved a high percentage (73%) of paint markings on low volume roads, while only 28% of thermoplastic markings were on low volume roads. The fact that crash rates are lower on high ADT roads than on low ADT roads is well known. As a result, a bias was inadvertently included in their models. They also failed to separate the seasonal variation of safety from the effect that markings were installed on the same month of each year, as pointed by Bahar et al. [31].

Lee et al. [30] conducted a study of 50 locations in Michigan where retroreflectivity of different types of pavement markings were measured over three years and compared with the number of nighttime crashes that are potentially associated with low retroreflectivity. They were not able to identify any relationship between them.

Most published literature studied the safety impact of longitudinal markings using the before-and-after method. However, these studies failed to include the actual values of retroreflectivity in their studies. Using data covering 118,000 non-intersection, non-daylight crashes and 5,000 miles of highways and freeways with known marking installation data over a period of eight years, the recent study by Bahar et al. [31] analyzed the safety effect of pavement marking and marker retroreflectivity. NTPEP data were used to derive mathematical models of retroreflectivity performance as a function of age, color, marking material type, climatic region, and amount of snow removal. An innovative approach was developed to identify the safety impact of pavement marking retroreflectivity. They found that there is no safety benefit of higher retroreflectivity for longitudinal markings on non-daylight conditions and at non-intersection locations that are maintained at proper levels.

## **Research in Progress**

A search on current research in progress was conducted from the Research in Progress (RiP) Web site from the Transportation Research Board (TRB) (<http://rip.trb.org/browse/lmap.asp>). Currently, many states are conducting pavement marking performance analysis (North Carolina, Kentucky, Texas, Iowa, and Maryland), including consideration of pavement marking minimum retroreflectivity, service life, and life cycle cost. Texas and Iowa are developing or implementing pavement marking management systems. Texas, Maryland, and Mississippi are conducting tests on pavement marking materials including retroreflectivity, color, and durability. Furthermore, NCHRP is also conducting tests on pavement marking color while Vermont is conducting tests on durability. Many states are conducting studies on the performances that are specific to their own states.



## DATA

Data used in this study are from LADOTD. Specifically, these data include:

- approximately 200 unit bid prices for installation or removal of retroreflective striping material on Louisiana's interstate system for letting dates from the first half of 2007,
- approximately 3,500 retroreflectivity field readings from Louisiana interstate freeways from 2002 to 2007, and
- roadway and traffic data.

The unit bid price data included project number, letting date, low bid and low bid contractor, high bid and high bid contractor, average bid, number of bids, and job size (in lane-miles) stratified by pavement marking material type. The majority of the data were for marking application, and only a small portion was for marking removal.

The retroreflectivity data included route number, direction, log mile (location), project number, contractor name, material, line color, line type, marking installation date, reading date, and retroreflectivity values. The retroreflectivity readings cover almost all major interstate highways in Louisiana, including I-10, I-12, I-20, I-49, I-55, I-310, I-510, and I-610.

Using the information associated with the retroreflectivity readings, the roadway sections where the retroreflectivity readings were taken were first identified and then related to the LADOTD segment database to obtain roadway and traffic information for the sections. The information obtained included average daily traffic, number of lanes, and pavement surface type.

Table 8 presents a summary of the features of the data. In terms of line color, tapes have only been used for lane lines (white), and not for yellow edge lines; inverted materials have only been used for PCC, not for AC. In terms of line type, tapes have only been used as dash (skip) lines, and all other materials have only been used as solid lines. This study assumes that the performance of the solid lines is the same as that of dash lines.

The retroreflectivity readings were collected from sites with various ADTs. The ADT distribution of the readings is representative of the overall ADT distribution of Louisiana interstate highways, as shown in figure 13.

**Table 8**  
**Data availability**

Pavement Type	Material	Line Color	Line Type
PCC	40 mil	White and Yellow	Solid
	90 mil	White and Yellow	Solid
	Tape	White	Dash
	Inverted	White and Yellow	Solid
AC	40 mil	White and Yellow	Solid
	90 mil	White and Yellow	Solid
	Tape	White	Dash
	Inverted	N/A	N/A

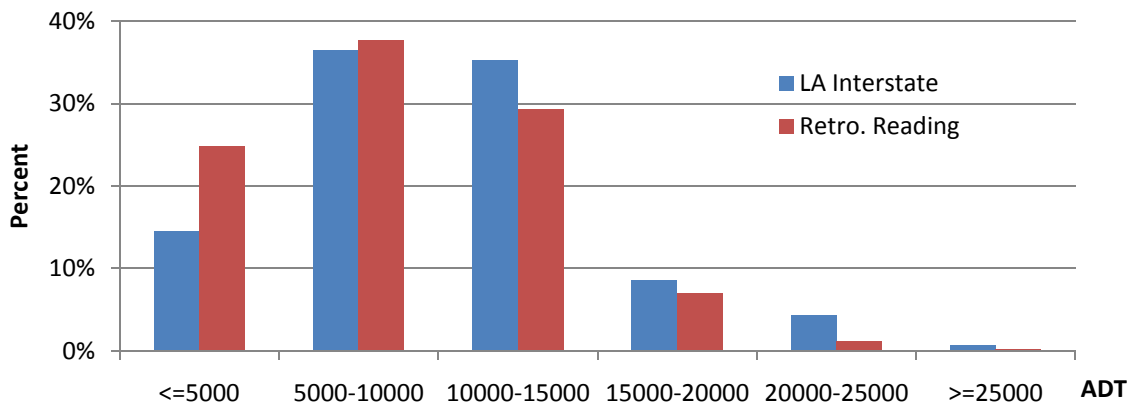
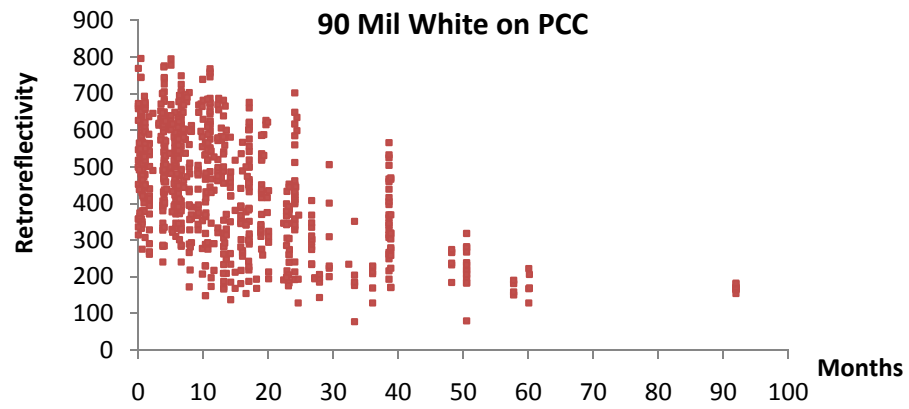

**Figure 13**

**ADT distribution of Louisiana Interstate and retroreflectivity reading sites**

One potential problem with the retroreflectivity data is that they are not product specific. The readings are identified by the type of material (for example, tape or inverted) but not by product (for example, Stamark High Performance Tape 380i ES from 3M or Durable 1000i from Brite-Line Technologies). Therefore, the analysis has to be conducted on aggregated products in each material type, such as those listed in table 8. Analysis of the NTPEP data, which does have information on each product, showed that a large part of the variation in retroreflectivity readings is due to differences among products. As a result, there are large variations in pavement marking performance in the Louisiana data, as shown in figure 14. Similar variation is observed in other studies. The consequence is that any model fitted to the data provides an average response among all products within a certain type of material, but it does not represent an individual product well.





**Figure 14**  
**Retroreflectivity as a function of time for a marking material**



## METHODOLOGY

One of the objectives of this study is to identify the best pavement marking material to apply in a given situation. To accomplish this, the benefit to the public in terms of visibility and the monetary cost of providing such pavement markings will be estimated. Based on the benefits and costs, benefit/cost ratios will be calculated and used to evaluate the different pavement marking materials, given the conditions in which they are to be applied. The material with the highest ratio is the preferred choice.

### Measuring User Benefit

Loetterle et al.'s study [16] of public perception of pavement marking retroreflectivity leads to an intuitively appealing way to measure user benefit. Based on their data, user benefit can be considered to increase approximately in a linear fashion when retroreflectivity is under 200 mcd/m<sup>2</sup>/lux, while above 200 mcd/m<sup>2</sup>/lux, there is little additional benefit. Thus, provided the retroreflectivity is at least 200 mcd/m<sup>2</sup>/lux, full benefit of the pavement marking is received. On the other hand, below a certain minimum threshold value of retroreflectivity, pavement markings are considered to be unacceptable and have no value to the driving public. If we call these two values  $R_{\max}$  and  $R_{\min}$ , respectively, and set  $R_{\max} = 200$  mcd/m<sup>2</sup>/lux and  $R_{\min} = 100$  mcd/m<sup>2</sup>/lux, then figure 15 demonstrates an alternative measurement of user benefit to those used by other agencies (i.e., Kansas and Virginia DOTs), as shown in the diagram.

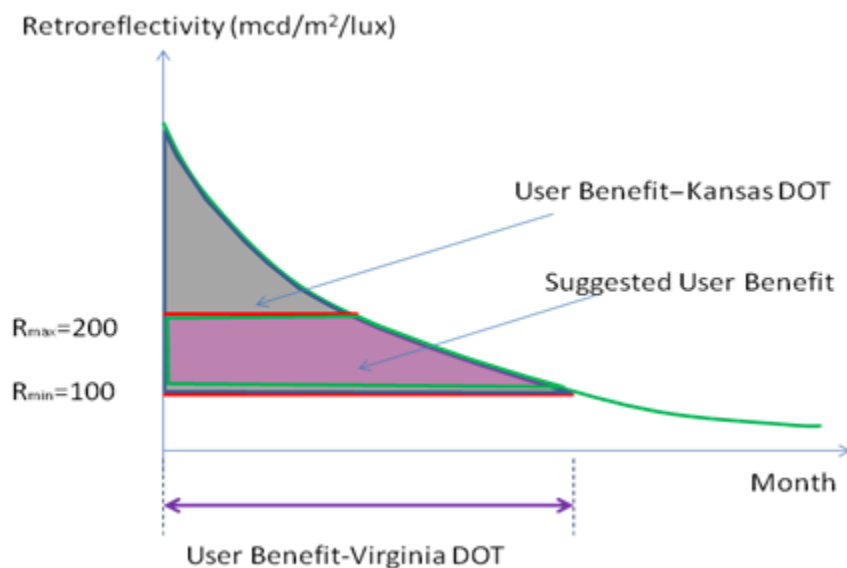

**Figure 15**  
**Measure benefit based on user perception**

The suggested user benefit is measured by the area between  $R_{\min}=100$  mcd/m<sup>2</sup>/lux and  $R_{\max}=200$  mcd/m<sup>2</sup>/lux. Benefit is measured in units of month\*vehicle\*mcd/m<sup>2</sup>/lux. In comparison to the suggested measurement of user benefit, the Kansas method overestimates user benefit, particularly that with high initial retroreflectivity values. As a result, the Kansas method is biased toward materials with high initial retroreflectivity values, such as tape. On the other hand, the Virginia method disregards the difference in pavement marking retroreflectivity values between  $R_{\min}=100$  mcd/m<sup>2</sup>/lux and  $R_{\max}=200$  mcd/m<sup>2</sup>/lux, where user satisfaction varies. As a result, the Virginia method tends to favor materials with low initial retroreflectivity.

### **Modeling Pavement Marking Retroreflectivity**

Note in figure 15 that user benefit is a function of the retroreflectivity curve. Thus, to accurately measure user benefit, an accurate estimation of the retroreflectivity curve is crucial. Past research suggested that retroreflectivity is a function of a number of variables, including

- marking material,
- pavement surface type (PCC/AC),
- line color,
- traffic (ADT),
- climate, and
- quality control during application.

The climate variable usually refers to the amount of snowfall and the number of snow plow operations, which is not a factor in Louisiana. It is also impacted by the geographic climate regions, such as “cold, dry, altitude” for Minnesota; “warm, wet, altitude” for Oregon; “hot, humid, gulf state” for Louisiana; etc. Given that climate is relatively consistent within Louisiana, climate was not considered as a factor affecting retroreflectivity in this study. In addition, quality control during application was not considered in this study because no data was available on this variable. The rest of the variables, i.e., marking material, pavement surface type, line color, and traffic (ADT), were considered when modeling the pavement marking retroreflectivity curve in this study. This was achieved by estimating a model for every combination of marking material, surface type, and line color with ADT, month, and CTP as independent variables. The method of multiple regression analysis was used in this study.

## Estimating User Cost

User cost due to lane closure was estimated using FHWA's RealCost [40]. RealCost is a spreadsheet-based program designed for life cycle cost analysis. Calculating user cost is only part of its capability. To estimate user cost requires several input parameters, including:

- ADT,
- vehicle composition,
- hourly demand,
- work zone configuration,
- work zone hours of operation,
- Consumer Price Index (CPI), and
- reliability factors.

Other cost components, such as application and removal costs, were estimated directly from the unit bid price data.

## Evaluating Pavement Marking Material

Having correctly measured user benefit from pavement markings and estimated the total monetary cost incurred by providing the markings, the following benefit/cost ratio was used to evaluate pavement marking performance:

$$\text{benefit / cost} = \frac{\text{single user benefit} * \text{ADT}}{\text{total cost per mile}}, \quad (12)$$

where the single user benefit is the area identified earlier in figure 15. The numerator represents the total user benefit during the time when the pavement marking retroreflectivity is above the minimum threshold. The benefit/cost ratio represents the total benefit to the public per unit cost.

## Generating Equivalent Cost Factors

In this study, benefit/cost ratio was chosen as the criterion on which to evaluate alternative pavement marking materials. However, when bids are received from contractors proposing alternative materials, it is their bid prices that must be compared. The methodology below describes how cost factors can be developed which when multiplied with bid prices on each

material, produce price estimates that reflect the benefit cost ratios of the respective materials. These factors are called “equivalent cost factors” because they indicate how much cost must be altered in order for the benefit cost ratio among alternatives to be the same

Assume:

$C_m$  = cost of marking material, including application and removal costs,

$C_u$  = user delay cost due to lane closure,

$C$  = total cost, and  $C = C_m + C_u$ ,

$B/C$  = benefit-cost ratio.

Further assume two marking materials 1 and 2; and  $(B/C)_2 > (B/C)_1$ , i.e.,

$$\frac{B_2}{C_{m2} + C_{u2}} > \frac{B_1}{C_{m1} + C_{u1}}. \quad (13)$$

There is the potential to increase  $C_{m2}$  to  $C_{m2}'$ , such that  $(B/C)'_2 = (B/C)_1$ , i.e.,

$$\frac{B_2}{C_{m2}' + C_{u2}} = \frac{B_1}{C_{m1} + C_{u1}}. \quad (14)$$

The user delay costs  $C_{u1}$  and  $C_{u2}$  are likely to be the same and are replaced by  $C_u$ . Solving for  $C_{m2}'$  we have

$$C_{m2}' = \frac{C_{m1}B_2 + (B_2 - B_1)C_u}{B_1} \quad (15)$$

The meaning of  $C_{m2}'$  is that the cost of marking material 2 ( $C_{m2}$ ) can be increased to  $C_{m2}'$  so that material 2 has the same benefit-cost ratio as material 1. Defining the equivalent cost factor for material 2, in reference to material 1, as the ratio of their costs, we have:

$$F_{2/1} = \frac{C_{m1}}{C_{m2}'} = \frac{C_{m1}B_1}{C_{m1}B_2 + (B_2 - B_1)C_u} = \frac{B_1}{B_2 + (B_2 - B_1)\frac{C_u}{C_{m1}}}. \quad (16)$$

Of course, the equivalent cost factor for material 1 in reference to material 1 is:

$$F_{1/1} = 1 \quad (17)$$

Equivalent cost factors are, generally, only valid in pairwise comparisons. For example, if there is a third material, material 3, with  $(B/C)_3 > (B/C)_2$ , and non-zero user delay cost ( $C_u$ ), then:

$$F_{3/2} \neq F_{3/1}/F_{2/1} \quad (18)$$

That is, the equivalent cost between materials 3 and 2 should generally not be inferred from the equivalent cost of material 3 to 1, and material 2 to 1. To compare materials 3 and 2, the equivalent factors have to be calculated with either material 2 or 3 as the reference.

The usefulness of equivalent cost factors is in being able to compare alternative bids involving different pavement marker materials. Multiplying bid prices by their equivalent cost factor allows identification of the preferred material (based on the benefit cost ratio principle), by the lowest priced material. Equivalent cost factors were obtained for Louisiana by analyzing data of past material costs in the state. These standard equivalent cost factors were adopted in this study to allow bids on alternative materials to be evaluated.

To demonstrate the application of standard equivalent cost factors in evaluating bid prices, suppose bid prices for materials 1, 2, and 3 are received, and they are  $U_1$ ,  $U_2$ , and  $U_3$ . If the standard equivalent cost factors of the materials with reference to material 1 are  $F_{3/1}$ , and  $F_{2/1}$  ( $F_{1/1}$  equals 1), the materials can be compared on the basis of the following transformed prices,  $P_1$ ,  $P_2$ , and  $P_3$ , which are the product of the original bid price and the respective equivalent cost factor:

$$P_1 = F_{1/1}U_1, \quad P_2 = F_{2/1}U_2, \quad P_3 = F_{3/1}U_3. \quad (19)$$

Note, if  $P_1$  is the lowest, then material 1 has the highest benefit/cost ratio and is the most attractive alternative. If  $P_1$  is the highest, then both materials 2 and 3 have higher benefit/cost ratios than material 1. In this case, we need to compare materials 2 and 3 using factors with either one as the reference. If  $P_1$  is inbetween  $P_2$  and  $P_3$ , say  $P_2 < P_1 < P_3$ , then it indicates that material 2 has a higher benefit/cost ratio than material 1, so material 2 is preferable to material 1. However, we still need to compare material 2 and material 3 because  $P_3 > P_1$  does not necessarily guarantee material 2 has a higher benefit/cost ratio than material 3. To compare materials 2 and 3, we use factors with either materials 2 or 3 as the reference. Assuming material 2 is the reference and the equivalent cost factor of material 3 with reference to material 2 is  $F_{3/2}$  then a new set of transformed prices, are:

$$P'_2 = U_2 \text{ and } P'_3 = F_{3/2}U_3. \quad (20)$$

The one with the lower cost value is will be the preferred material among the three materials.

Although the use of equivalent cost factors is convenient in comparing alternative bids, we suggest using benefit/cost ratio as the criterion to evaluate alternative marking materials. Using equivalent cost factors to compare material costs is an approximation and it may not always produce the correct results, especially when the bid prices are very different from the past average costs. In contrast, the benefit/cost ratio method always enables the user to identify the material with the highest benefit/cost ratio, no matter what the bid prices are.



## MODEL ESTIMATION

### Estimating Pavement Marking Retroreflectivity

Regression analysis was used to relate various roadway and pavement marking characteristics to observed retroreflectivity. Different functional forms of regression analysis were tested during model estimation, including linear, negative exponential, and logarithmic. The negative exponential model was found to fit the data best and was adopted in this study, although in certain cases the logarithmic model provided better coefficients of multiple correlation ( $R^2$ ) values. The higher  $R^2$  value from the logarithmic models are due to the model providing better fit for data at the beginning of pavement marking life, when the initial retroreflectivity values are usually much higher than 200 mcd/m<sup>2</sup>/lux. However, the exponential models achieved better model accuracy at or near the end of marking service life, and this is important in accurately calculating user benefit.

For each marking material, line color, and pavement surface type, a different model was estimated. Variables tested included month after application, ADT per lane, and CTP. Marking materials included thermoplastic (both 40 and 90 mil), tape, and inverted profile marking. Pavement surface type included PCC and AC, and line colors included white and yellow. As a result, a total of 14 retroreflectivity models were estimated, as shown in table 9. In the table, “lnR” represents the natural log of the retroreflectivity value.

**Table 9**  
**Estimated model by material, line color, and pavement surface type**

Material	Color	Pave. Type	Estimated Model	$R^2$
40 mil	white	PCC	$\ln R = 5.8250 - 0.0079 * \text{Months} - 0.0559 * \text{CTP}$	0.46
		AC	$\ln R = 6.094 - 0.0383 * \text{ADT}/1000 - 0.0165 * \text{Months}$	0.55
	yellow	PCC	$\ln R = 5.3943 - 0.0079 * \text{Months} - 0.0559 * \text{CTP}$	synthetic
		AC	$\ln R = 5.6632 - 0.0383 * \text{ADT}/1000 - 0.0165 * \text{Months}$	synthetic
90 mil	white	PCC	$\ln R = 6.3492 - 0.0114 * \text{Months} - 0.0160 * \text{CTP} - 0.0109 * \text{ADT}/1000$	0.41
		AC	$\ln R = 6.5181 - 0.0253 * \text{ADT}/1000 - 0.0154 * \text{Months}$	0.35
	yellow	PCC	$\ln R = 5.7496 - 0.0053 * \text{ADT}/1000 - 0.0134 * \text{Months}$	0.23
		AC	$\ln R = 5.9059 - 0.0162 * \text{ADT}/1000 - 0.0110 * \text{Months}$	0.18
Tape	white	PCC	$\ln R = 6.9132 - 0.0113 * \text{ADT}/1000 - 0.0188 * \text{Months}$	0.89
		AC	$\ln R = 7.2082 - 0.0459 * \text{ADT}/1000 - 0.0316 * \text{Months}$	0.57
	yellow	PCC	$\ln R = 6.4824 - 0.0113 * \text{ADT}/1000 - 0.0188 * \text{Months}$	synthetic
		AC	$\ln R = 6.7774 - 0.0459 * \text{ADT}/1000 - 0.0316 * \text{Months}$	synthetic
Inverted	white	PCC	$\ln R = 6.1985 - 0.0484 * \text{ADT}/1000 - 0.0129 * \text{Months}$	0.25
	yellow	PCC	$\ln R = 5.6434 - 0.0177 * \text{Months}$	0.44

Four models are marked as synthetic. This is because there are either no data available for model estimation, as in the case of yellow tape on asphalt AC and PCC pavements, or an acceptable model could not be estimated using the data, as was the case for yellow 40 mil tape on AC and PCC pavements. The models for these four yellow line pavement markings were created by assuming that they follow the same pattern of decay as white lines, but with 65% initial retroreflectivity values of white lines [14]. There are only two models estimated for inverted markings on PCC; this is because inverted markings have not been used on AC pavement in Louisiana, and no such data are available from NTPEP.

Table 10 presents the observed maximum month of marking service and the retroreflectivity values at the observed maximum month of service, along with model predicted month of marking service when the minimum retroreflectivity value of 100 mcd/m<sup>2</sup>/lux is reached for all fourteen models at different ADT per lane values. The predicted values vary in general with ADT, and the lower the ADT value, the higher the predicted pavement marking service life. A comparison between observed and model predicted values in the table provides some indication of the validity of the model predictions. Keep in mind when comparing them that the observed maximum month is obtained from observing retroreflectivity with a wide variety of ADT values, while the model predicted month is based on a single ADT value.

**Table 10**  
**Observed vs. model predicted pavement marking service life**

Material/Color/Surface			Observed Max. Month	Retro. at Max. Month	Model Prediction: Month When Retro.=100				
					5000	10,000	15,000	20,000	25,000
					ADT Per Lane				
40 mil	white	PCC	51	158	75	49	37	29	24
		AC	51	110	79	67	55	44	32
	yellow	PCC	51	174	48	32	24	19	16
		AC	51	184	53	41	29	18	6
90 mil	white	PCC	92	169	122	101	85	73	63
		AC	57	222	116	108	100	91	83
	yellow	PCC	92	99	83	81	79	77	76
		AC	57	138	111	104	96	89	81
Tape	white	PCC	104	145	120	117	114	111	108
		AC	35	334	75	68	61	53	46
	yellow	PCC	N/A	N/A	97	94	91	88	85
		AC	N/A	N/A	61	54	47	40	32
Inverted	white	PCC	56	180	105	86	67	48	30
	yellow	PCC	56	128	59	59	59	59	59

Take white 90 mil markings on PCC as an example. The observed maximum month is 92, at which the retroreflectivity value is 169 mcd/m<sup>2</sup>/lux, which is well above the minimum threshold of 100 mcd/m<sup>2</sup>/lux. The model predicted 122 months at 5000 ADT. The 122 months prediction is reasonable, considering the observed value of 92 months with a retroreflectivity value of 169 mcd/m<sup>2</sup>/lux. However, there are model predictions in which we have less confidence. For example, for yellow 90 mil on AC and white inverted on PCC, the observed maximum month is 57 and 56, while the models predicted almost twice the observed values (111 and 105 months for 90 mil and inverted respectively), with observed retroreflectivity values of 138 mcd/m<sup>2</sup>/lux and 180 mcd/m<sup>2</sup>/lux for 90 mil and inverted respectively. The observed maximum months are too short to assess the reasonableness of the model predictions. In contrast, predictions from the two synthetic models for yellow 40 mil on PCC and AC seem to be somewhat low. Note that data for yellow inverted on PCC indicated that the service life does not vary with ADT. As a result, the estimated model is a function of month only. Overall the model predictions for most cases are in the reasonable range, and the results seem believable.

### **Estimating User Cost**

User costs are estimated separately depending on the number of lanes (either two or three) in one direction and striping operating schedules. Two operating schedules are assumed for urban areas; they are daytime off-peak (from 9 a.m. to 3 p.m.) and nighttime (from 8 p.m. to 6 a.m.). Only one operating schedule is assumed for rural areas: daytime off-peak operation (from 8 a.m. to 2 p.m.). Traffic parameters used are the averages during the time periods. Table 11 gives the values of the parameters used in RealCost for calculating user costs. Many of the values were taken from the default values in LADOTD's LIFECOST. The traffic percentage is the average hourly percent of daily traffic occurring in the specified period (i.e., 5.40 percent during the day and 1.57% during the evening).

**Table 11**  
**Parameter values used to calculate user cost due to lane closure**

Parameters	Values
Traffic percentage	5.40% (daytime)
	1.57% (nighttime)
Free flow speed	65 miles/hour
Free flow capacity	2200 vphpl* (2 lanes)
	2300 vphpl (3 lanes)
Queuing length	100 mile (assuming unlimited queue length)

(continued on next page)

(continued)

Parameters	Values
Queue dissipation rate	1818 vphpl
Single unit truck %	5%
Combination truck %	6%
Work zone length	1 mile
Work zone time	1 hour
Work Zone speed	55 miles/hour
Traffic direction	both
Work zone capacity	1360 vphpl (50% reliability, 1 of 2 lanes open)
	1540 vphpl (50% reliability, 2 of 3 lanes open)
CPI** factors	1.29 (year 2007 for user cost)
	1.36 (year 2007 for vehicle operating cost)

\*vehicles per hour per lane.

\*\*Consumer Price Index.

ADT per lane is the only variable used when calculating user cost. Figure 16 plots the user cost as a function of ADT per lane for 2- and 3-lane freeways for both daytime off-peak and nighttime operations.

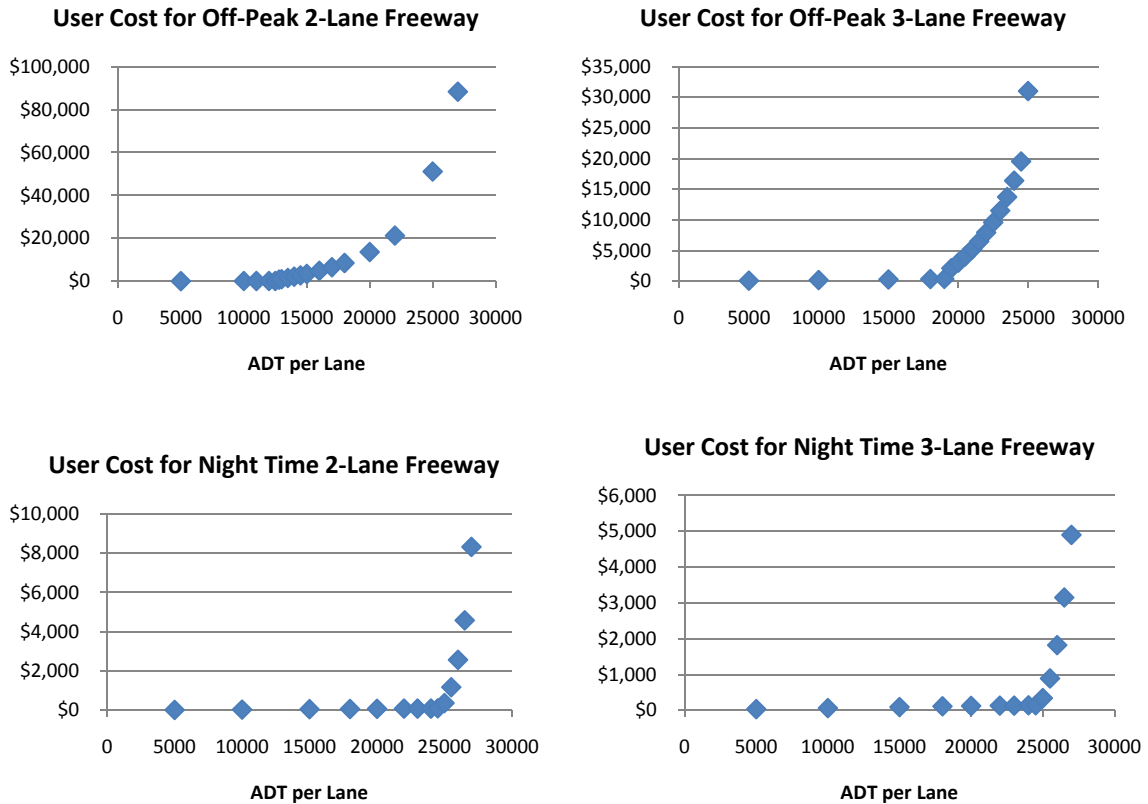

**Figure 16**  
User cost by number of lanes and time of operation

Based on the results from the calculation, regression models were estimated. Each curve is fitted with two models based on ADT values, as show in table 12. The models all have excellent R<sup>2</sup> values.

**Table 12**  
**Regression models for calculating user cost**

		low ADT	high ADT
<b>2-lane</b>	daytime	UserCost = 38.9exp(0.119*ADT/1000) (ADT<=12500, R <sup>2</sup> =0.995)	UserCost = 27.34* exp(0.306*ADT/1000) (ADT>12500, R <sup>2</sup> =0.966)
	nighttime	UserCost = 3.930*ADT/1000+0.578 (ADT<25000, R <sup>2</sup> =0.991 )	UserCost = 2E-14exp(1.516*ADT/1000) (ADT>=25000, R <sup>2</sup> =0.975 )
<b>3-lane</b>	daytime	UserCost = 69.37exp(0.093*ADT/1000) (ADT<=19000, R <sup>2</sup> =0.970 )	UserCost = 0.480exp(0.438*ADT/1000) (ADT>19000, R <sup>2</sup> =0.987 )
	night ime	UserCost = 5.675*ADT/1000 + 3.713 (ADT<25000, R <sup>2</sup> =0.995 )	UserCost = 2E-12exp(1.32*ADT/1000) (ADT>=25000, R <sup>2</sup> =0.976 )

**Estimating Application and Removal Costs**

The application cost was estimated from low bid data. Figure 17 presents the application cost per mile from the low bid for 90 mil thermoplastic markings as an example. For job size larger than 1 mile, the low bid costs are fairly constant. After eliminating two outliers, the mean cost per mile for job size equal to or greater than 1 mile is \$2,458; the standard deviation is \$337. The mean application costs per mile for all materials are presented in table 13.

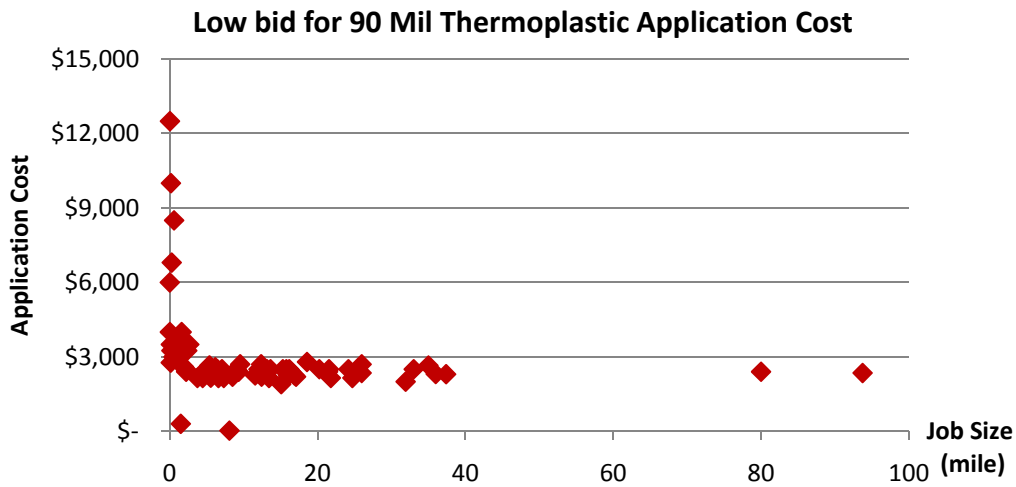

**Figure 17**  
**Application cost of a 90 mil marking material by job size**

Removal cost for 12 projects is presented in figure 18. The mean removal cost per mile is \$5,250, with a standard deviation of \$1,003. These removal costs are also presented in table 13. There is no data for application cost for tape as solid lines. The value is estimated assuming the same ratio between solid and dash lines for inverted materials.

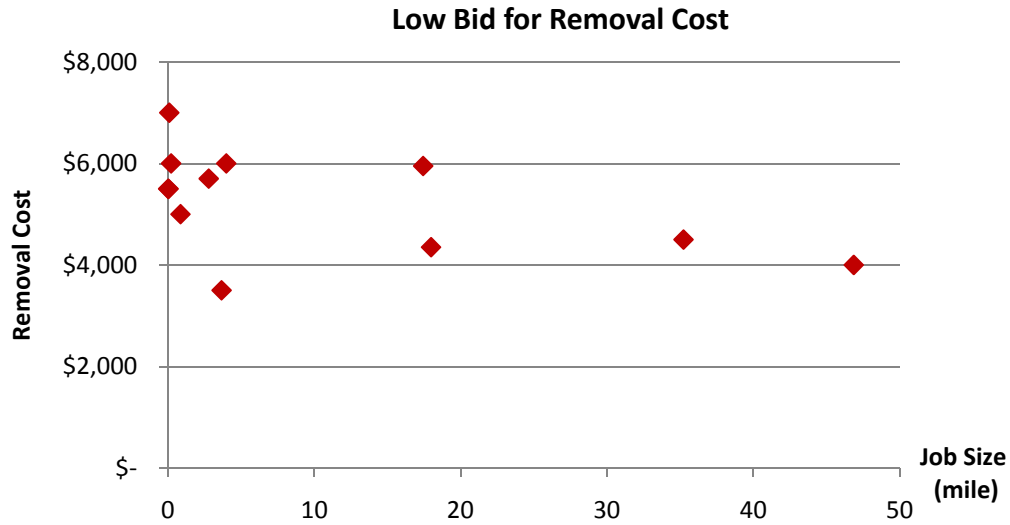

**Figure 18**  
Removal cost of all materials by job size

**Table 13**  
Average application and removal costs

Material	Average Application Cost Per Mile (\$)		Average Removal Cost Per Mile (\$)	
	Solid	Dash	Solid	Dash
40 Mil	1,039	391	5,250	5,250
90 Mil	2,458	817	5,250	5,250
Tape	8,108	3,861	5,250	5,250
Inverted	5,270	2,505	5,250	5,250

These cost values are the average of all applications and removals and are used as default average costs in this study. However, for different operating schedules, the cost may be different. For example, nighttime operations may have a higher cost, and daytime operation may have a lower cost than the averages. The opportunity is given to alter these values for daytime and night time operation, as described in item 4 of the “Input” section in the next section.

## MODEL OPERATION

The final product of the project is a Microsoft Excel spreadsheet workbook named “PMValue.xlsx” with built-in macros. It can be used to evaluate the performance of different pavement marking materials on Interstate highways under different conditions. The marking materials include 40 mil thermoplastic, 90 mil thermoplastic, tape, and inverted thermoplastic. The conditions include pavement surface type (PCC or AC), restripe (for existing pavement) or new stripe (for new pavement), traffic conditions (ADTs per lane and number of lanes), time of operation (off-peak daytime operation or nighttime operation), and average application and removal costs per mile. Users need to make simple selections among choices and input certain values, although default values are provided throughout. Results are presented in graphical form. Intensive error checking routines have been incorporated into the spreadsheet to prevent users from inputting invalid values. This is a read only workbook that users are advised not to alter except to make selections/input in the authorized areas. The project is implemented on Microsoft Office Excel 2007. Before launching the program, users need to enable the macro capability. To do so, please refer to Microsoft Office 2007 for help.

### Input

The “Input” worksheet, shown in figure 19, is the only active sheet users have access to once the program is launched. Users are required to provide five types of input:

1. General Information

Two types of information are required. The first is pavement surface type. The choice is either PCC or AC. The second is whether the marking line is a restripe or new stripe. A restripe may involve removal of old material, while a new stripe does not. Users input these values by selecting from the selection list.

2. Traffic Options

These options refer to the ADT values per lane for the section of the pavement. Five ADT values have been selected. They are 5000; 10,000; 15,000; 20,000; and 25,000 vehicles per day, per lane. Users can add an additional ADT value for analysis. To add an additional value, simply select the “Yes” choice and then input the value. The ADT values are restricted to be between 5000 and 27,000. This is because the range includes almost all the ADT values observed on Louisiana freeways, and our models are most

accurate within that range. To select a different ADT value, first select “No” then “Yes” again.

### 3. Analysis Options

The user can specify the minimum effective retroreflectivity values for white and yellow lines (default values are 100 mcd/m<sup>2</sup>/lux), the maximum effective retroreflectivity value (default value is 200 mcd/m<sup>2</sup>/lux), and the remaining pavement service life in months. These input values are used to calculate the user benefit for each pavement marking.

### 4. Application/Removal Costs

Default values for application and removal costs are provided, or users can input their own values. Clicking on the “Restore Default Marking Cost Values” button will restore the default values. Different default values are provided for different pavement surface types selected in General Information. However, these values are the average application and removal costs. For the two assumed operation schedules, daytime off-peak and nighttime, two different input values can be used to reflect the costs that may be different from the average costs. These are the percent decrease/increase factors for off-peak/nighttime operations. The factors are in percentages.

### 5. User Cost Due to Lane Closure

Default values are provided for both 2-lane and 3-lane freeways in one direction as well as for the two operating schedules. Users can elect to input their own user cost values. The default values can be restored by clicking on the “Restore Default User Cost Values.” If users add ADT values for analysis in input part 2 (Traffic Options), default user cost values will be calculated for those ADT values and provided in the user cost table.

## **Evaluation**

After providing the necessary input values, users can perform two types of operations. One is to calculate the equivalent cost factors and the other is to evaluate the pavement marking materials by clicking the corresponding buttons at the bottom of the “Input” worksheet. The program will make calculations using the method and models discussed earlier for each of the pavement marking materials, including thermoplastic 40 mil, thermoplastic 90 mil, tape, and inverted. After each calculation, the analysis results will be provided in a new worksheet,



as will be discussed next. To analyze another scenario, users can go back to the “Input” worksheet and repeat the procedures discussed above. If a material is not part of the evaluation, it is advised not to delete the cost values or set them to zero; instead, to leave the default values so that the output graphics which had been set to auto scale, will display properly.

	A	B	C	D	E	F
1	<b>INPUT WORKSHEET</b>	<b>Important: This workbook should be set to read only!</b>				
2						
3	<b>1. General Information</b>					
4	Pavement Surface Type	PCC	PCC			
5	Restripe/New Stripe	Restripe	Restripe			
6	<b>2. Traffic Options (ADT per Lane)</b>					
7	(5000, 10000, 15000, 20000, and 25000 are defaults)					
8	Additional ADT Value for Analysis	No	<input checked="" type="radio"/> No <input type="radio"/> Yes			
9	<b>3. Analysis Options</b>					
10	Minimum Effective Retroreflectivity (white)	100	Set New Value			
11	Minimum Effective Retroreflectivity (yellow)	100	Set New Value			
12	Maximum Effective Retroreflectivity	200	Set New Value			
13	Remaining Pavement Service Life (Month)	100	Set New Value			
14	<b>4. Application/Removal Costs</b>					
15	Please Input Cost Values in the Table	Restore Default Marking Cost Values				
16	Or Use the Provided Default Values					
17		<b>Average Application Cost Per Mile (\$)</b>		<b>Average Removal Cost Per Mile (\$)</b>		
18	<b>Material</b>	<b>Solid</b>	<b>Dash</b>	<b>Solid</b>	<b>Dash</b>	
19	<b>40 Mil</b>	1,039	391	5,250	5,250	
20	<b>90 Mil</b>	2,458	817	5,250	5,250	
21	<b>Tape</b>	8,108	3,861	5,250	5,250	
22	<b>Inverted</b>	5,270	2,505	5,250	5,250	
23	% Decrease for Off-Peak Application Cost	15	Set New Value			
24	% Increase for Night Time Application Cost	15	Set New Value			
25	<b>5. User Cost Due to Lane Closure</b>					
26	Number of Lanes in One Direction	2	2	Restore Default User Cost Values		
27	Please Input Cost Values in the Table	<b>ADT/Lane</b>	<b>Off-Peak (\$/mile)</b>	<b>Night Time (\$/mile)</b>		
28	Or Use the Provided Default Values	5000	\$ 71	\$ 20		
29		10000	\$ 128	\$ 40		
30		15000	\$ 2,693	\$ 60		
31		20000	\$ 12,436	\$ 79		
32		25000	\$ 57,432	\$ 576		
33		No				
34		Calculate Equivalent Cost Factors		Evaluate Marking Materials		
35						
36						

**Figure 19**  
User interface after launching the program

Based on user input, results of the analysis are presented in a new output worksheet in graphical form. User input values are also summarized and presented in tabular form in the same worksheet. Clicking on the “Print Results” button will print out four pages of the output for user record. Example results discussed on the following pages use a restriping application on PCC with additional users’ selected ADT value of 13,000.

#### 1. Marking Benefit/Cost by ADT

This is the main result of the analysis and is shown in figure 20. It provides the users with the benefit/cost ratio of different marking materials for different traffic loading conditions (ADTs) for different line types under the two application schedules for the selected pavement surface type. Obviously, the higher the bar in each diagram, the higher the benefit/cost ratio, and therefore, the most economical material under each condition can be identified by the dominating benefit/cost ratio bar in the diagram.

#### 2. Marking and User Delay Costs

This part of the output provides additional information that is related to cost. Application cost, removal cost, and user delay cost are provided for the two operating schedules (daytime off-peak and nighttime), as shown in figure 21.

#### 3. User Benefit and Expected Service Life

This part of the output provides information on user benefits and expected service lives of the materials by line type (yellow edge, white edge, and white lane lines), as shown in figure 22. Combined with the cost information discussed above, users can analyze why one material has higher benefit/cost values than another and perhaps identify pros and cons of different pavement marking materials in terms of benefits and costs.

#### 4. Data Used in the Analysis

The entire user specified input values for the analysis are recorded for the user’s record, as shown in figure 23.

**Restripe-PCC: Marking Benefit/Cost by ADT**

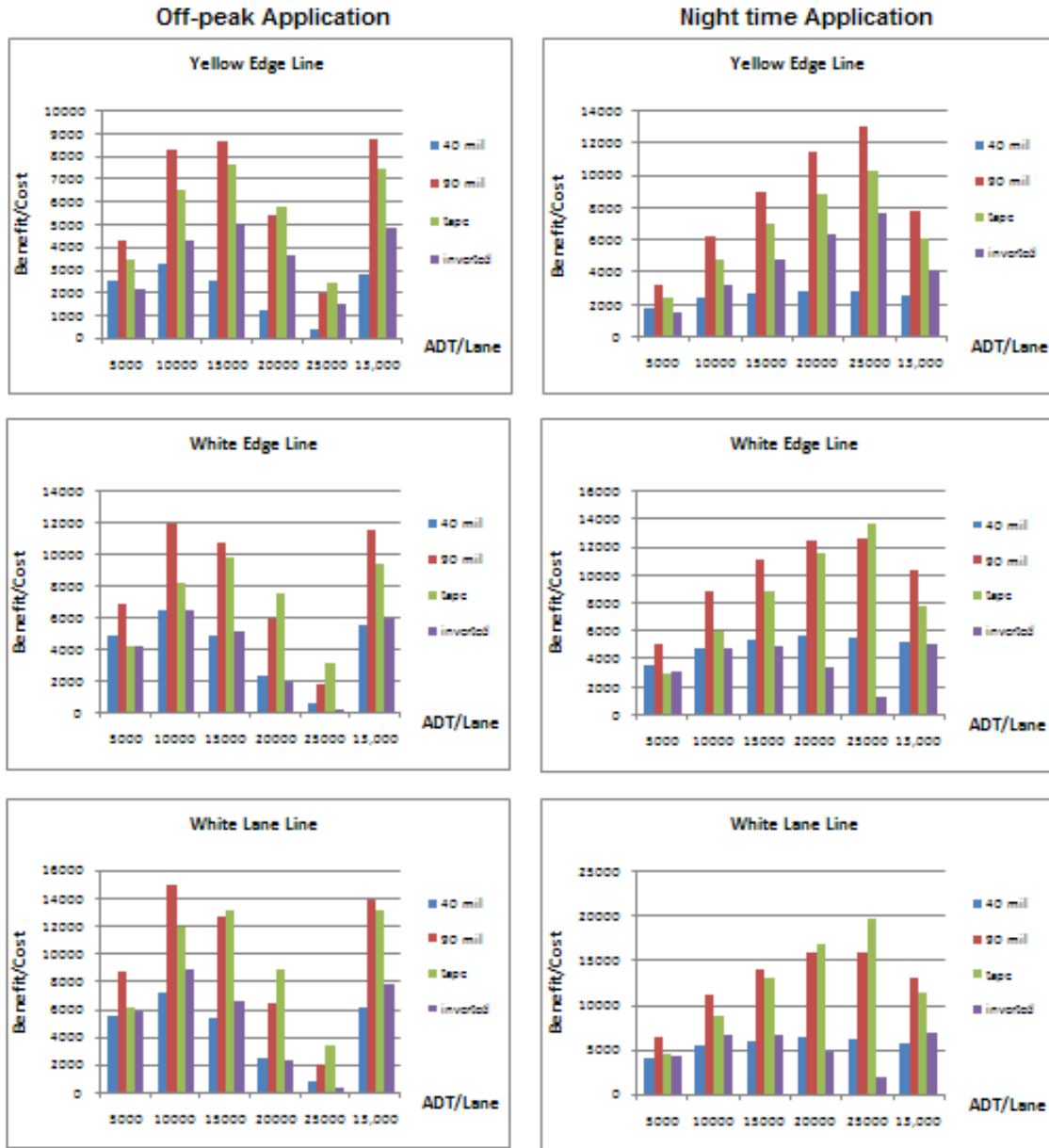

PMValue.xlsm, output for Restripe-PCC

Output page 1 of 4

**Figure 20**  
**Result of analysis: benefit/cost ratio by ADT**

**Restripe-PCC: Marking and User Delay Costs**



**Figure 21**  
Application, removal, and user delay costs

**Restripe-PCC: User Benefit and Expected Service Life**

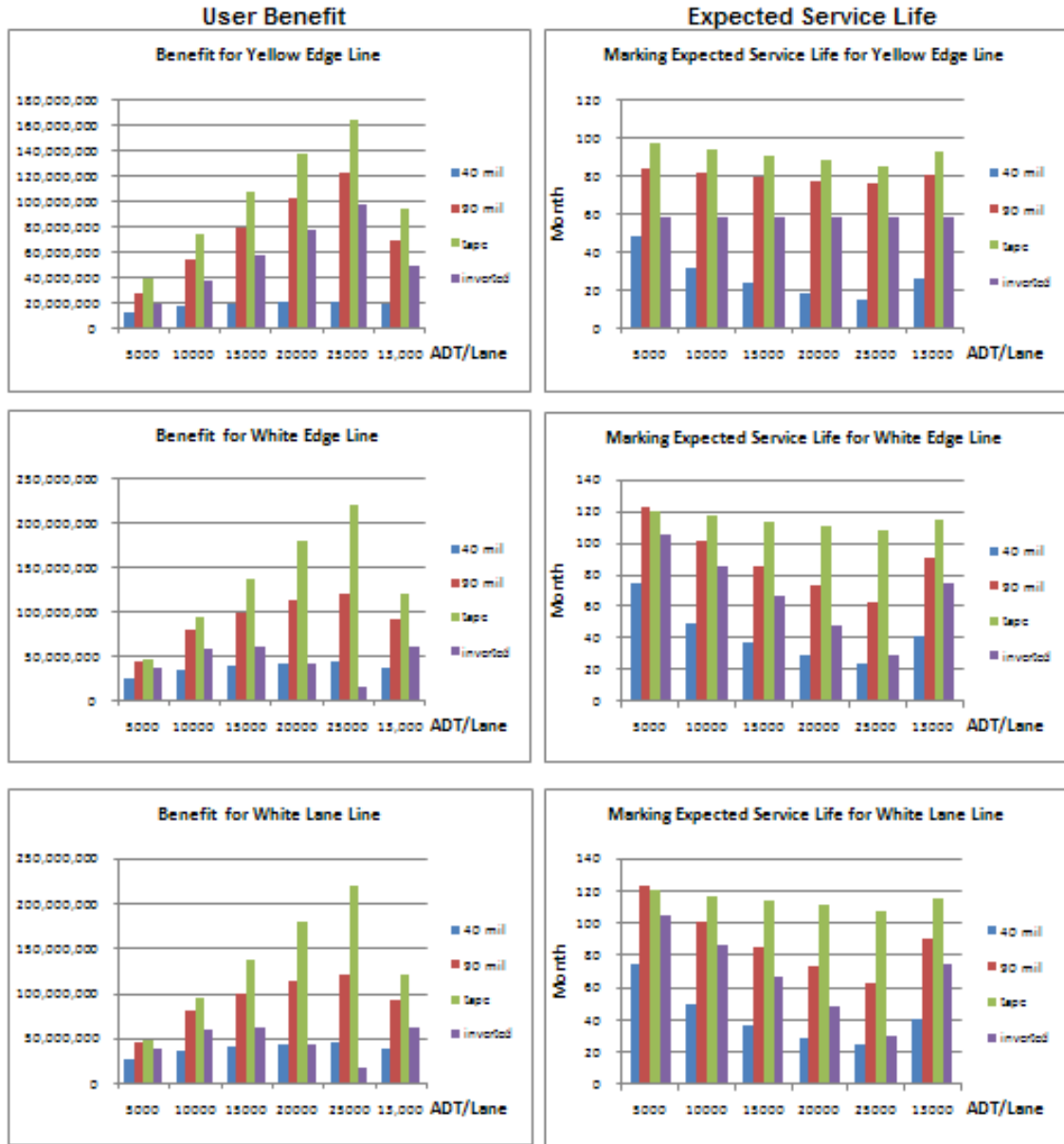

**Figure 22**  
**Estimated benefit and pavement marking service life**

---

**Restripe-PCC: Data Used in the Analysis**

---

**Variables**

Pavement Surface Type	PCC
Restripe/New Stripe	Restripe
Additional ADT Value for Analysis	No
Minimum Effective Retroreflectivity (white)	100
Minimum Effective Retroreflectivity (yellow)	100
Maximum Effective Retroreflectivity	200
Remaining Pavement Service Life (Month)	100
% Decrease for Off-Peak Application Cost	15
% Increase for Night Time Application Cost	15
Number of Lanes in One Direction	2

**Application/Removal Costs (\$/mile)**

Material	Average Application		Average Removal	
	Solid	Dash	Solid	Dash
40 Mil	1038	391	5250	5250
90 Mil	2458	817	5250	5250
Tape	8108	3861	5250	5250
Inverted	5270	2505	5250	5250

**User Costs (\$/mile)**

ADT/Lane	Off-Peak	Night Time
5000	71	20
10000	128	40
15000	2693	60
20000	12438	79
25000	57432	578
No		

**Print Results**

**Figure 23**  
**Result of analysis: user input data**

## Calculating Equivalent Cost Factors

If users choose to calculate the equivalent cost factors, the results will be presented in a new worksheet named “Equivalent Cost Factors”. Some notes on how to use the factors are provided and users are asked to select the reference material. Based on the users’ choice, the equivalent cost factors with the selected material as reference are presented in a table. The factors are organized by pavement marking line type, marking material, and ADT per lane, as shown in figure 24. Example of how to use the factors are presented in the section “Generating Equivalent Cost Factors.”

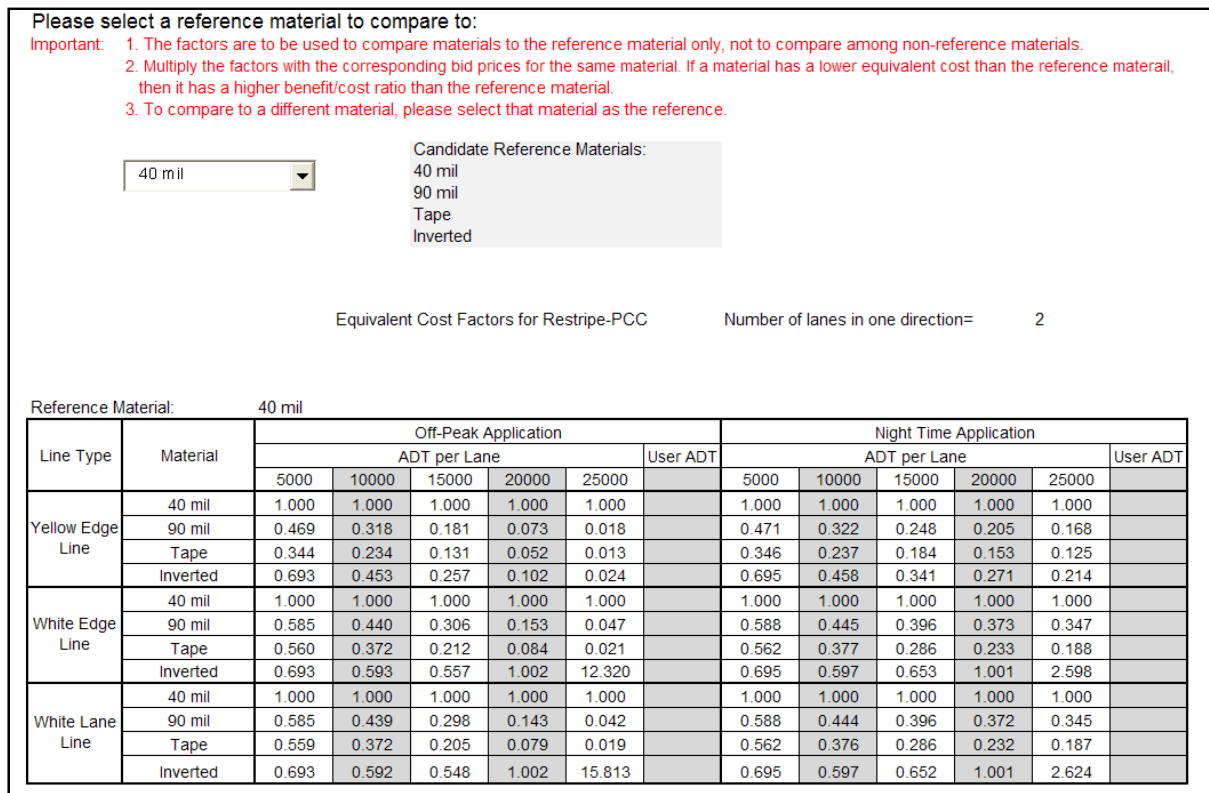

**Figure 24**  
**Output of equivalent cost factor program**



## RESULTS AND ANALYSES

We examine application of the model when users choose the option “Evaluate Marking Materials.” Because so many variables can be varied within the model, only some scenarios are analyzed to demonstrate how the model can be used.

### Analysis 1: Yellow Edge Line on Concrete Pavement Applied in Daytime Off-Peak

We begin with an analysis of a yellow edge line to be restriped on the PCC surface of a four lane two-way freeway. The remaining pavement service life is assumed to be 100 months, and the time of application is daytime off-peak. For all other variables, the default values are used. Figure 25 presents the benefit/cost ratios for all four types of marking materials, as obtained from the model.

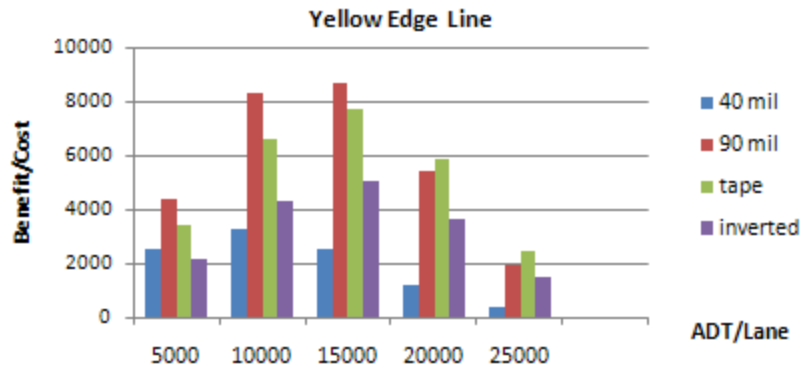

**Figure 25**  
**Benefit/cost ratios for a yellow edge line**

From figure 25, the benefit/cost ratios for all materials first increase as ADT increases, then they decrease as ADT continues to increase. At low ADTs ( $\leq 15,000$ ), 90 mil has the highest benefit/cost ratios; at high ADTs ( $\geq 20,000$ ), tape becomes the best alternative. Such results are expected and are due to the changes of two factors: the benefits and costs of the marking materials, which are analyzed in detail below.

Figure 26 presents the benefits of all materials at different ADTs. The unit for benefit is month\*vehicle\*mcd/m<sup>2</sup>/lux. The benefits increase as traffic volume increases. However, the increase for tape is the highest because tape has longer service life than other materials.

Figure 27 shows the costs, including application cost, removal cost, and user cost due to lane closure. All materials have the same removal costs. However, tape has very high application cost. Compared to 90 mil, the application cost for tape is almost 3.5 times as high. The user

cost does not increase significantly until ADT reaches 20,000 vehicles per day. At low ADTs, the high application cost and relatively low benefit of tape (although higher than 90 mil) results in its lower benefit/cost ratios than 90 mil. As ADT increases, the benefits for tape increase faster than 90 mil, and the user cost, which is the same for all materials, also becomes significant. This results in higher benefit/cost ratios for tape than 90 mil.

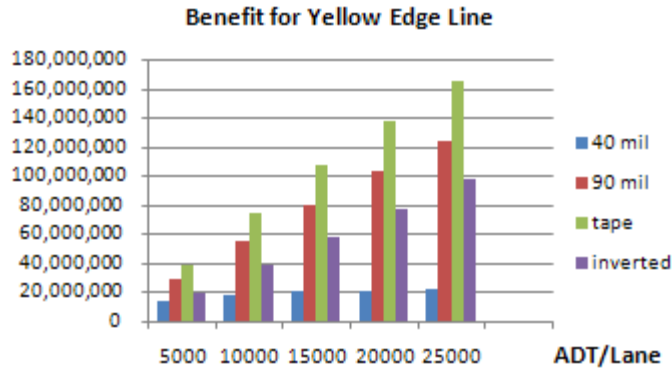

**Figure 26**  
**Benefit of a yellow edge line by ADT**

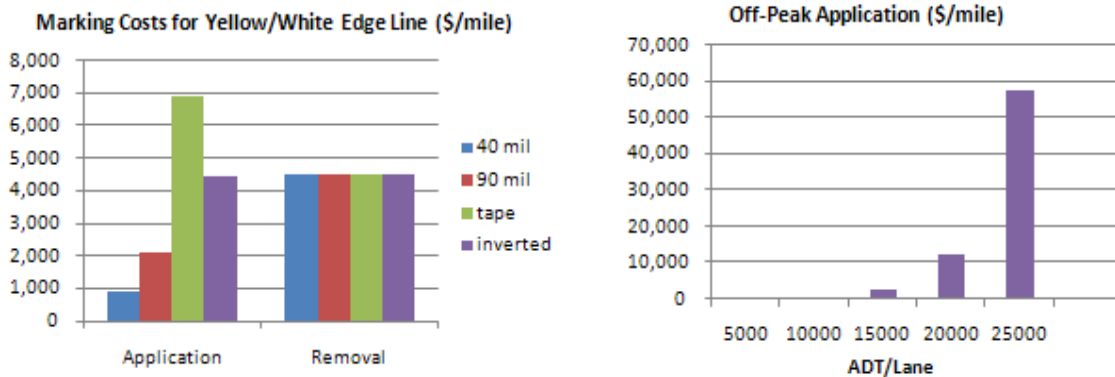

**Figure 27**  
**Application, removal, and user costs of a yellow edge line**

**Analysis 2: Daytime vs. Nighttime Application**

Next, the results of the same yellow edge line are examined in terms of whether the restriping is done during daytime during off-peak period or at nighttime. The benefit/cost ratios for the two different restriping schedules are presented in figure 28. All the variables take the same values as used in analysis 1. In the calculation, daytime off-peak application costs are assumed to be 15 percent less than the average application and removal costs, while nighttime application costs 15 percent more than the average application and removal costs.

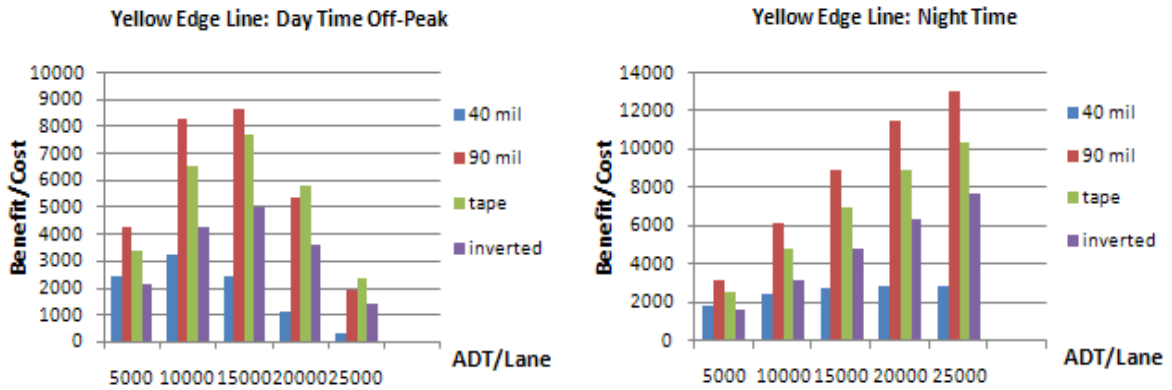

**Figure 28**  
**Benefit/cost ratios for daytime off-peak and nighttime restripes**

From the results in figure 28, daytime application is associated with higher benefit/cost ratios at low ADTs (<15,000); while at high ADTs ( $\geq 20,000$ ), nighttime application provides higher benefit/cost ratios. This is because at low ADTs, nighttime operation has increased application and removal costs compared to daytime off-peak, while user delay cost is low. At high ADTs, user delay cost during daytime operation becomes so high that it offsets the decreased daytime application and removal costs, resulting in a higher total cost, as shown in figure 29. Notice from figure 28 that for nighttime application, tape is no longer the best choice with high ADTs ( $\geq 20,000$ ), as in the case for daytime off-peak application. This is due to the large decreased total cost of nighttime application for 90 mil.

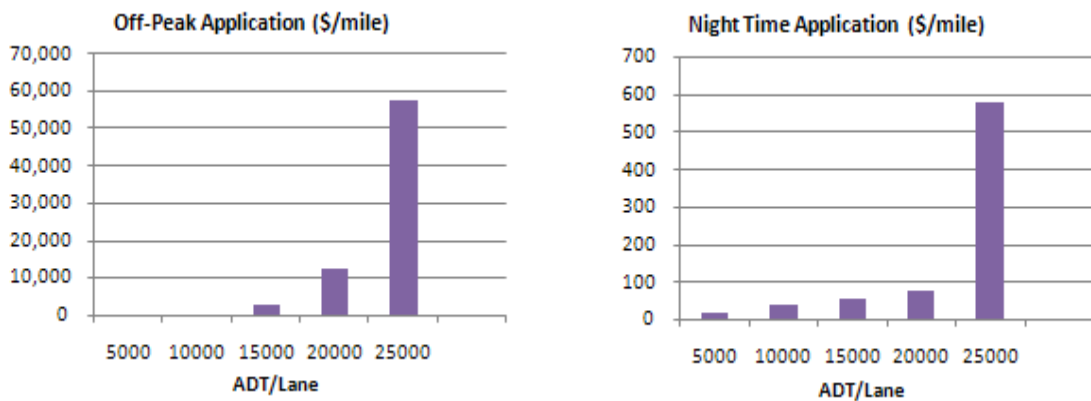
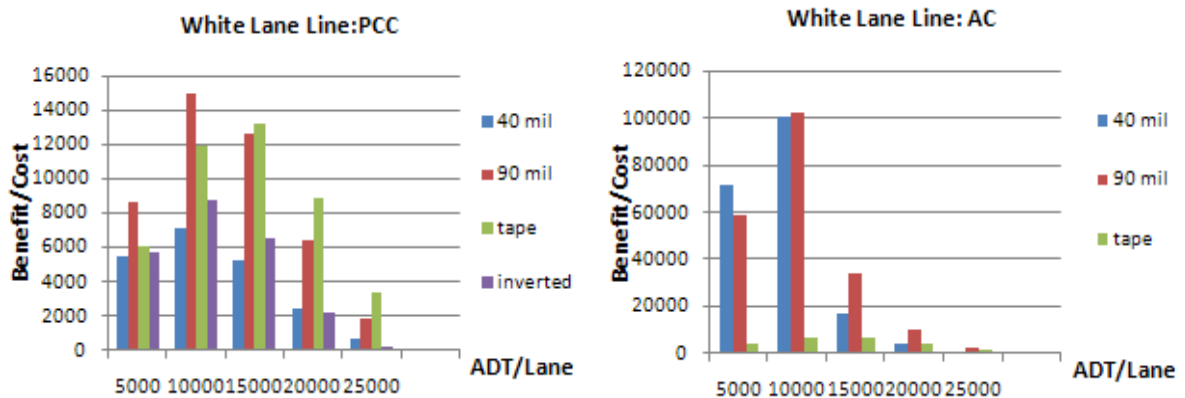

**Figure 29**  
**User delay costs for daytime off-peak and nighttime applications**

### Analysis 3: Concrete Pavement vs. Asphalt Pavement

In analysis 3, a different type of line is used for analysis: a white lane line instead of the yellow edge line used earlier. The focus is on analyzing the impact of different pavement

surface types: PCC and AC. Daytime off-peak application is used, and all the variable values are the same as in analysis 1. The benefit/cost ratios are presented in figure 30.



**Figure 30**  
**Benefit/cost ratios for a white lane line on PCC and AC**

The results indicate that for PCC pavement, 90 mil is the best choice at low ADTs ( $\leq 10,000$ ), and tape is the best choice at high ADTs ( $\geq 15,000$ ). For AC pavement, 40 mil is the best alternative at low ADTs ( $< 10,000$ ); when ADT is around 10,000, 40 mil and 90 mil have similar benefit/cost ratios; however, 90 mil is the best choice at high ADTs ( $> 10,000$ ). This is because the thermoplastics (both 40 and 90 mil) perform well on AC. In contrast, tape has relatively poor performance on AC relative to that on PCC, making it impossible to justify the high application cost of the tape. There is no model for inverted marking materials on AC.

#### **Analysis 4: Different Pavement Remaining Service Lives: 100 vs. 10 Months**

We now examine the impact of pavement remaining service life on the selection of marking materials. Figure 31 presents two results for a white lane line on PCC applied in daytime off-peak periods; one assuming 100 months of remaining pavement service life and the other only ten months. All other variables take the same values as in analysis 3.

If the pavement has a long remaining service life (100 months in this example), 90 mil is the best choice at low ADTs and tape at high ADTs, respectively, as discussed earlier in Analysis 3. Because of the relatively short service life of 40 mil, it has the lowest benefit/cost ratios at low ADTs ( $< 15,000$ ) and second lowest benefit/cost ratios at high ADTs ( $\geq 20,000$ ). However, when the pavement remaining service life is very short (10 months in this case), 40 mil becomes the best alternative for all the ADTs selected for the analysis.

This can be attributed to the expected service lives of the marking materials, which were estimated from the Louisiana data, as shown in figure 32.

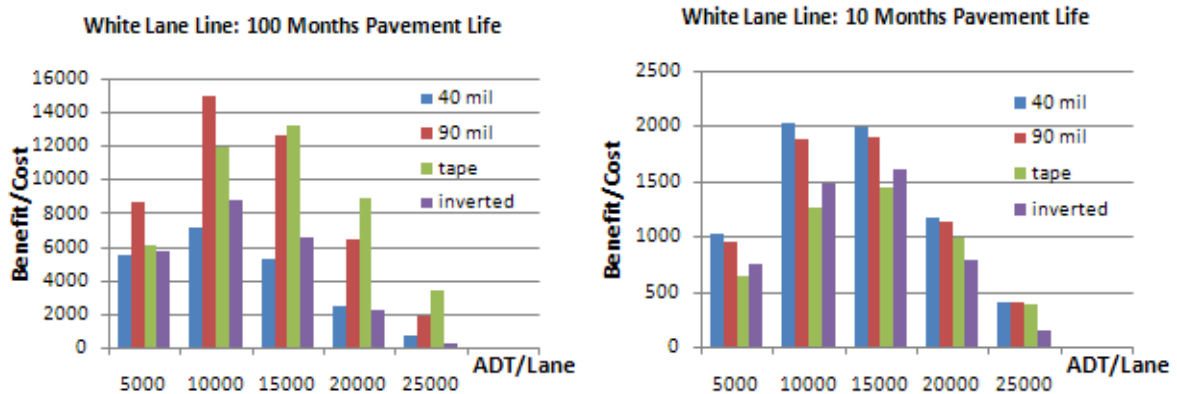

**Figure 31**  
**B/C ratios for white lane lines with different remaining pavement service life**

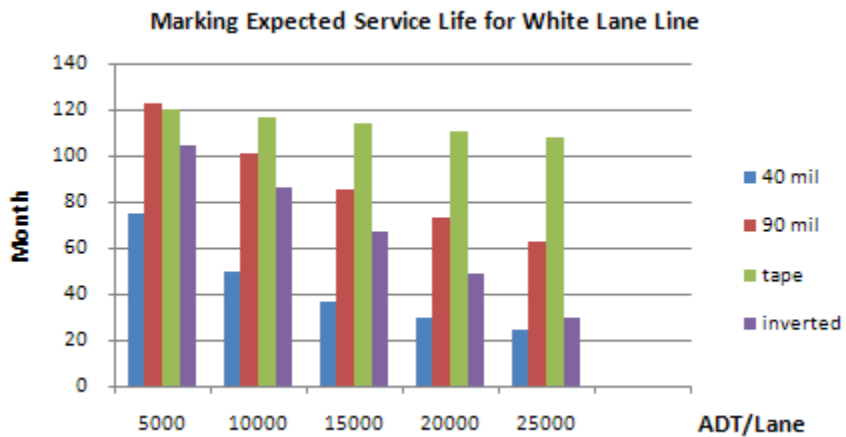

**Figure 32**  
**Expected marking service lives for different materials**

Figure 32 indicates that 40 mil has the shortest expected service lives under all traffic conditions among the materials. However, such expected service lives are still longer than the pavement remaining service life of 10 months. Any potential marking service life longer than the pavement life (10 months) will be wasted. As a result, the cheapest material—40 mil is the best choice.

**Analysis 5: Comparing the Method of This Study with the Kansas Method**

In the last example, the Kansas method and the methodology used in this study are compared. Based on the study of Loetterle et al. [16], this report used 200 mcd/m<sup>2</sup>/lux as the maximum

retroreflectivity value, beyond which there is no further user benefit. However, if the maximum retroreflectivity at which benefit is realized is allowed to equal the highest achievable initial retroreflectivity value, then the results will be the same as the Kansas method. To illustrate the difference between the results from the model developed in this study and that of the Kansas method, an analysis is conducted on the same white lane line on PCC that has been used in analysis 3. To obtain the Kansas results, the maximum retroreflectivity value is set to a very high value (1200 mcd/m<sup>2</sup>/lux). The results are shown in figure 33.

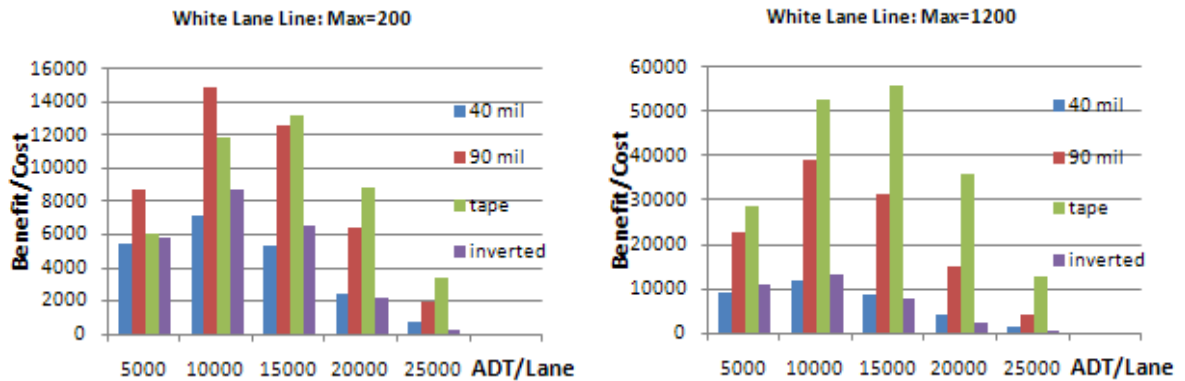

**Figure 33**  
**Comparison between the method used in this study and the Kansas method**

According to the methodology used in this study, 90 mil and tape are the best choices at low ADTs and high ADTs, respectively. However, the Kansas method chooses tape as the best alternative throughout. This is attributed to the calculation of benefit. The benefits from the two methods are presented in figure 34.

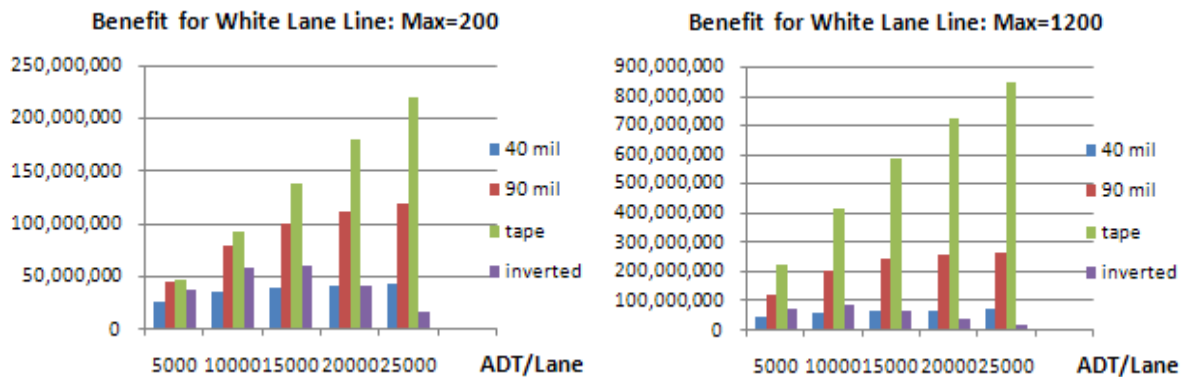

**Figure 34**  
**Different methods of calculating benefits**

From figure 34, the Kansas method produces much higher estimates of user benefit, especially from tape, when high initial retroreflectivity is experienced. In this example, the estimation of benefit for tape is 400–500 percent higher than that estimated with the model developed in this study. This clearly demonstrates that the Kansas method can produce very different results compared to the model produced in this study when considering materials with high initial retroreflectivity.





## RAISING CURRENT RETROREFLECTIVITY REQUIREMENTS

The second objective of this report is to estimate the benefit of increasing the starting and six month retroreflectivity specifications of pavement markings. Current requirements for 90 mil thermoplastic and tape are given in table 14. Inverted and 40 mil materials are not included in this study. Tape has only been used as white lane lines on Louisiana freeways. Therefore there are no data to study for yellow tape marking material.

**Table 14**  
**Current specifications on marking retroreflectivity (mcd/m<sup>2</sup>/lux)**

Time	90 Mil		Tape	
	White	Yellow	White	Yellow
7-30 Days	375	250	500	300
180 Days	325	200		
1 Year			400	240
4 Years			100	100

An investigation of the NTPEP data shows that there are large variations in retroreflectivity curves among different marking products for the same material type. The retroreflectivity performance of a marking material can be described in terms of two properties of the material: the initial retroreflectivity and the decay rate. In addition to the variation in initial retroreflectivity values in the NTPEP data, the decay rates are also very different. Figure 35 presents two negative exponential models estimated from two white 90 mil products based on the skip line data from NTPEP. The  $R^2$  values are 0.74 and 0.82 for products 1 and 2, respectively.

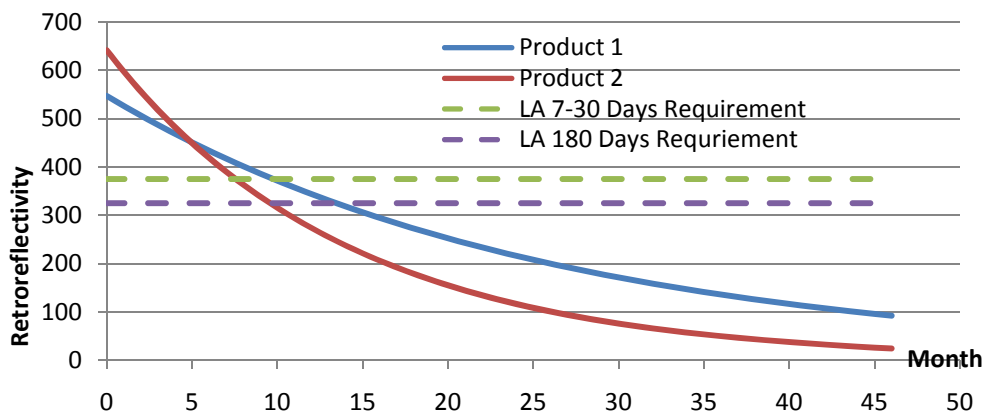

**Figure 35**  
**Retroreflectivity for two 90 mil thermoplastic products from NTPEP**

Louisiana requirements of a minimum retroreflectivity of 375 mcd/m<sup>2</sup>/lux within 7 to 30 days of placement of the marking material, or a minimum of 325 mcd/m<sup>2</sup>/lux within 6 months after placement of the material, are also plotted in figure 35. As can be seen, both materials satisfy the Louisiana requirements. However, product 1 reaches the threshold value of 100 mcd/m<sup>2</sup>/lux below which pavement marking retroreflectivity is often considered inadequate at approximately 45 months, while product 2 reaches this value after only 25 months, despite the fact that product 2 has higher initial retroreflectivity value. This demonstrates the importance of decay rate in determining marking service life.

Because the specifications apply to roads of all ADTs, only months in service (i.e., service life) is used to model retroreflectivity, and negative exponential models are assumed that can be used to adequately model the relationship between retroreflectivity and service life. The data shows little difference between models of PCC and AC. Therefore, the following discussion makes no effort to distinguish them.

### **Specifications for 90 Mil Thermoplastics**

The current requirements specify the retroreflectivity values in the first and sixth month. However, such specification does not necessarily set a requirement for the rate at which retroreflectivity decays. A material may have high starting and six months retroreflectivity values that meet the current specifications and yet have fast decay in retroreflectivity, resulting in short service life, as is the case for product 2 in figure 35. Therefore, the current specifications for 90 mil are recommended to change to the following two parts:

1. The minimum initial retroreflectivity values 7–30 days after the installation,
2. The maximum percentage decrease from the initial retroreflectivity value 180 days after the installation.

The maximum percentage decrease could be obtained from current specifications. For white 90 mil, the percentage of 325 (six month requirement) over 375 mcd/m<sup>2</sup>/lux (initial requirement) is 86.7 percent (close to 85 percent); for yellow 90 mil, the percentage of 200 (six month requirement) over 250 mcd/m<sup>2</sup>/lux (initial requirement) is 80.0 percent. As a result, the maximum percentages of decrease from the initial retroreflectivity values are 15 percent for white and 20 percent for yellow. Therefore, the suggested specifications for 90 mil are given in table 15.

**Table 15**  
**Suggested retroreflectivity specifications for 90 mil thermoplastics**

Time	White	Yellow
7-30 Days	Minimum Initial Retroreflectivity (375 mcd/m <sup>2</sup> /lux)	Minimum Initial Retroreflectivity (250 mcd/m <sup>2</sup> /lux)
180 Days	Maximum Decrease from Actual Initial Retroreflectivity (15%)	Maximum Decrease from Actual Initial Retroreflectivity (20%)

Based on the 15 percent and 20 percent maximum decrease assumptions, coefficients of negative exponential models using month as the sole variable can be derived. These models determine the retroreflectivity curve that meets the proposed maximum decay rates for different initial retroreflectivity values. The models can be expressed as:

for 15 percent maximum decrease

$$R = R_o * e^{-0.0271*month} \text{ and} \tag{21}$$

for 20 percent maximum decrease

$$R = R_o * e^{-0.0372*month}, \tag{22}$$

where  $R_o$  is the initial retroreflectivity and the coefficients for month are the decay rates. Two negative exponential models were estimated for 90 mil white and yellow marking materials with month as the only variable based on the Louisiana data. They are given in table 16 along with the model  $R^2$  values.

**Table 16**  
**Average 90 mil retroreflectivity models as a function of month**

Color	Model	$R^2$
White	$R = 529 * \exp(-0.0163 * month)$	0.35
Yellow	$R = 306 * \exp(-0.0130 * month)$	0.21

Figures 36 and 37 present the average Louisiana 90 mil thermoplastics retroreflectivity curves along with the newly suggested form of requirements for white and yellow respectively. The results show that on average, 90 mil thermoplastics in Louisiana not only meet the initial retroreflectivity requirement but also have slower decay rates than the required maximum of 15 and 20 percent decrease in six months.

If we assume that the decay rates do not vary with the initial retroreflectivity values, then the benefit of raising the initial retroreflectivity values can be estimated using the above decay rates. Figure 38 plots the retroreflectivity curves with initial retroreflectivity values of 375 and 450 mcd/m<sup>2</sup>/lux with the Louisiana average decay rate and the maximum 15 percent decay rates for white 90 mil.

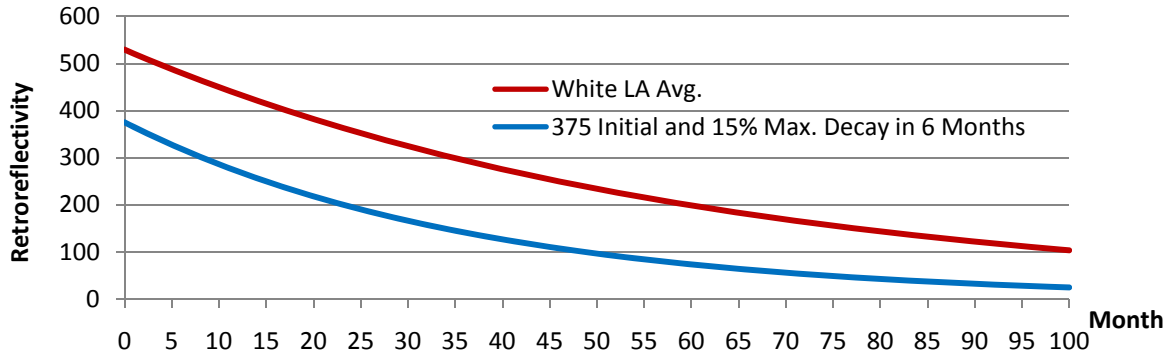

**Figure 36**

**Average Louisiana white 90 mil materials meet the new requirements**

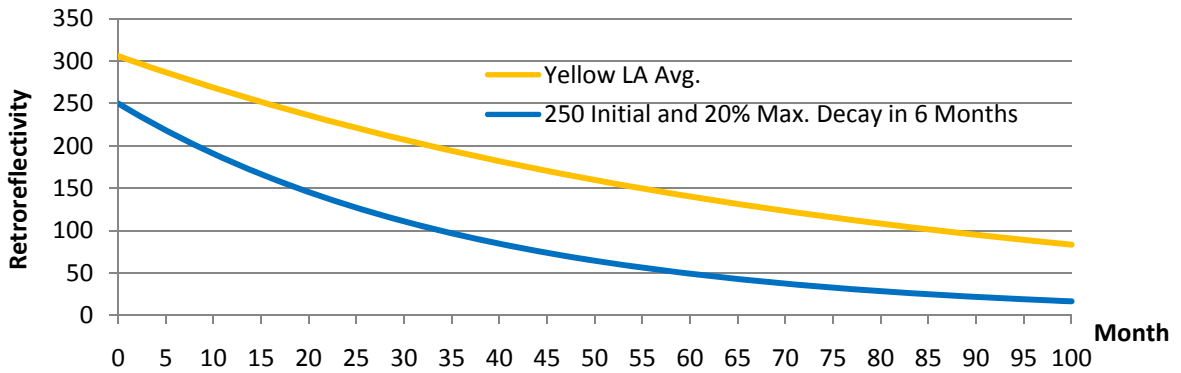

**Figure 37**

**Average Louisiana yellow 90 mil materials meet the new requirements**

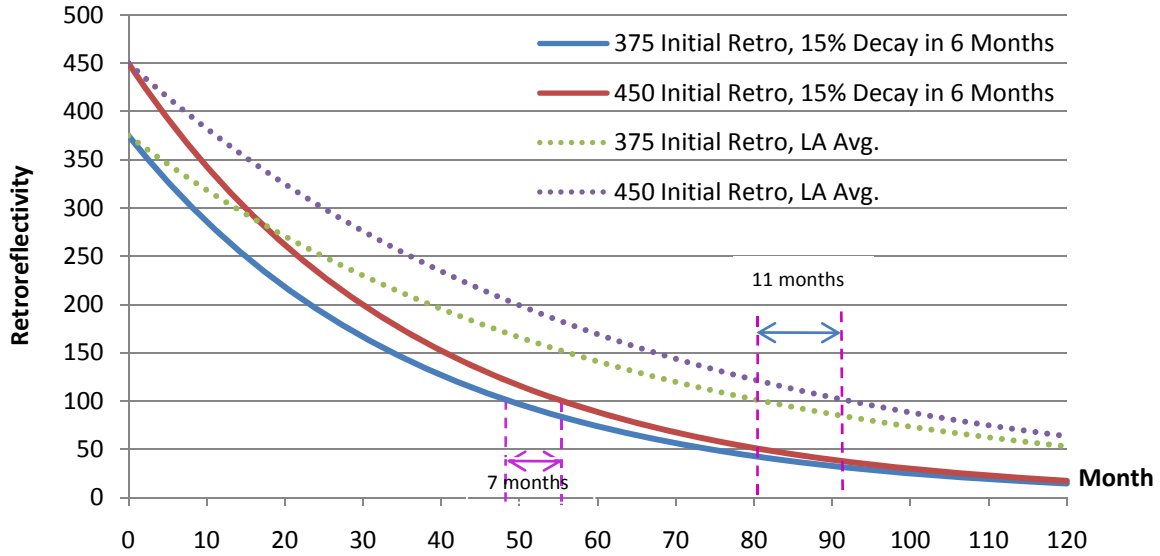

**Figure 38**

**Potential service life increases by raising initial retroreflectivity for white 90 mil**

From figure 38, if the initial retroreflectivity requirement is raised from current 375 to 450 mcd/m<sup>2</sup>/lux, the service life of white 90 mil thermoplastics will increase, at a minimum, from 49 months to 56 months (an increase of 7 months in service life), and on average, from 81 months to 92 months (an increase of 11 months in service life). The relationship between the change in initial retroreflectivity and the increase in months of marking service life is governed by the following equations.

$$\Delta month_{min}^{white} = 36.9 * \ln \left( \frac{R_0^{new}}{R_0^{old}} \right), \quad (23)$$

$$\Delta month_{avg}^{white} = 61.3 * \ln \left( \frac{R_0^{new}}{R_0^{old}} \right), \quad (24)$$

$$\Delta month_{min}^{yellow} = 26.9 * \ln \left( \frac{R_0^{new}}{R_0^{old}} \right), \text{ and} \quad (25)$$

$$\Delta month_{avg}^{yellow} = 76.9 * \ln \left( \frac{R_0^{new}}{R_0^{old}} \right), \quad (26)$$

where  $\Delta month$  is the change of marking service life in months, subscripts *min* and *avg* refer to minimum and average respectively, superscripts *white* and *yellow* denote white and yellow marking colors,  $R_0$  is the initial retroreflectivity value, and superscripts *new* and *old* indicate whether the initial values are old or new requirements. Based on the equations, figure 39

presents the potential gains of marking services lives by raising the initial retroreflectivity requirements from current 375 and 250 mcd/m<sup>2</sup>/lux for both white and yellow for 90 mil thermoplastics.

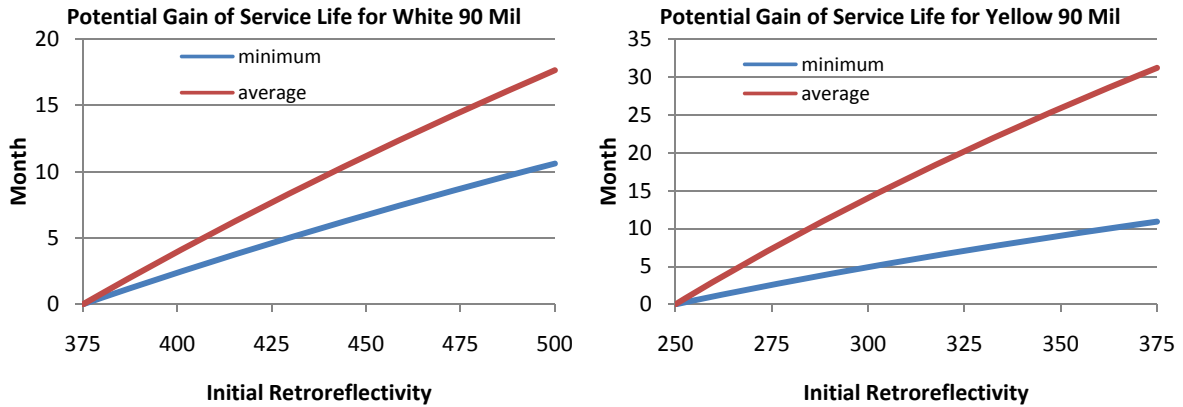

**Figure 39**  
**Potential service life increases by raising initial retroreflectivity requirements**

The results in figure 39 indicate that the higher the initial (7–30 days) retroreflectivity requirement, the higher the potential gain in marking service life. However, the new standard should be reasonable and achievable in practice. Figure 40 gives the percentage of markings that would fail both at different initial retroreflectivity levels and at their 180 days maximum decrease requirements for both white and yellow for 90 mil thermoplastics based on the Louisiana data.

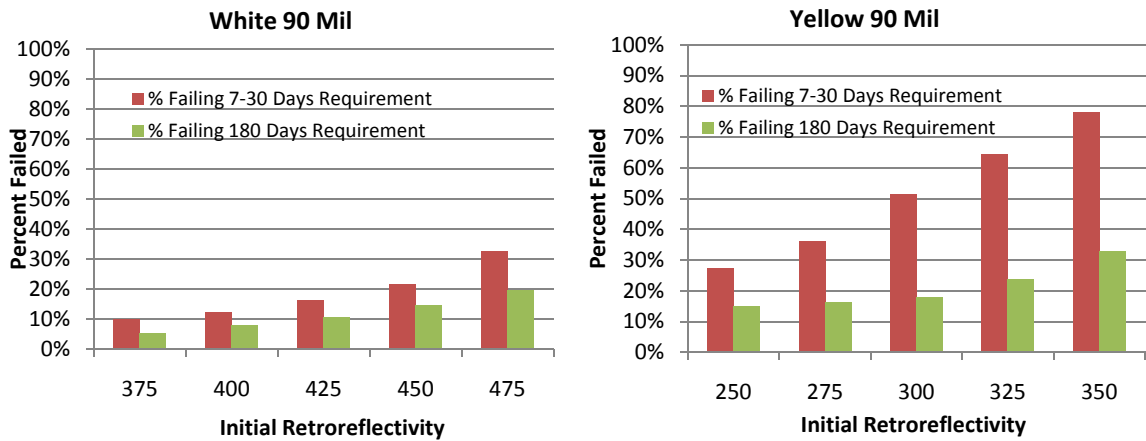

**Figure 40**  
**Percent 90 mil materials failing different initial retroreflectivity requirements**

The results in figure 40 demonstrate that 10.1 percent and 5.3 percent of white 90 mil thermoplastics would fail to meet the suggested specifications in table 15. However, more

yellow 90 mil thermoplastics would fail to meet the suggested specifications in table 15 (27.5 percent and 14.9 percent for 7–30 days and 180 days, respectively). The suggested specifications specify the minimum requirements for six months retroreflectivity values as a percentage of the initial retroreflectivity values instead of absolute values, as in the current specifications. Additionally, raising the initial retroreflectivity requirement for white 90 mil is more achievable in practice than for yellow 90 mil. For example, with initial retroreflectivity requirement raised from 375 to 425 mcd/m<sup>2</sup>/lux (an increase of 13.3 percent) for white, only 16.3 percent and 10.5 percent would fail to meet the new requirements for initial retroreflectivity and maximum decay rates. In contrast, an increase from 250 to 275 mcd/m<sup>2</sup>/lux (an increase of 10 percent) for yellow, 36.2 percent and 16.4 percent would fail the new requirements for initial retroreflectivity and maximum decay rate requirements, respectively.

### **Specifications for White Tape**

Similar analysis can be performed for white tape lines. However, the current specifications for tape are different from those for 90 mil (see table 14). The requirements for white tape at one year and four years, along with the initial retroreflectivity requirement, may specify two different retroreflectivity curves. The one year requirement is more stringent than the four years requirement because the coefficients for the negative exponential models are 0.0186 for one year and 0.0335 for four years requirements. As a result, the one year curve demands a much slower decay rate. The negative exponential model estimated for white tape based on the Louisiana data is:

$$R = 932 * \exp (-0.0195 * month) \tag{27}$$

The coefficients for the negative exponential models are 0.0186 and 0.0195 from the one year requirement and the Louisiana model, respectively. This indicates that based on the decay rate alone, while disregarding the high initial retroreflectivity values achieved by tape materials in Louisiana, the decay rate from the one year requirement is more stringent than that of tape in Louisiana on average.

A new but moderate requirement may be obtained by taking the average retroreflectivity values of both curves at six months and then specifying a new retroreflectivity curve. The average value is 426, which is 85.2 percent of the initial retroreflectivity value of 500. To be consistent with white 90 mil specifications, 85 percent is used, resulting in the same decay rate as 90 mil white (equation 21). To ensure long term performance, the four years requirement of 100 mcd/m<sup>2</sup>/lux can still be imposed for white tape. However, if a white tape

marking material meets the initial and six months requirements, it is likely to last longer than four years. Table 17 summarizes the suggested specifications for white tape.

**Table 17**  
**Suggested retroreflectivity specifications for white tape**

Time	White
7-30 Days	Minimum Initial Retroreflectivity (500 mcd/m <sup>2</sup> /lux)
180 Days	Maximum Decrease from Actual Initial Retroreflectivity (15%)
4 Years	Minimum Retroreflectivity (100 mcd/m <sup>2</sup> /lux)

Figure 41 presents the retroreflectivity curves for the different requirements, along with the retroreflectivity curve estimated with the Louisiana data.

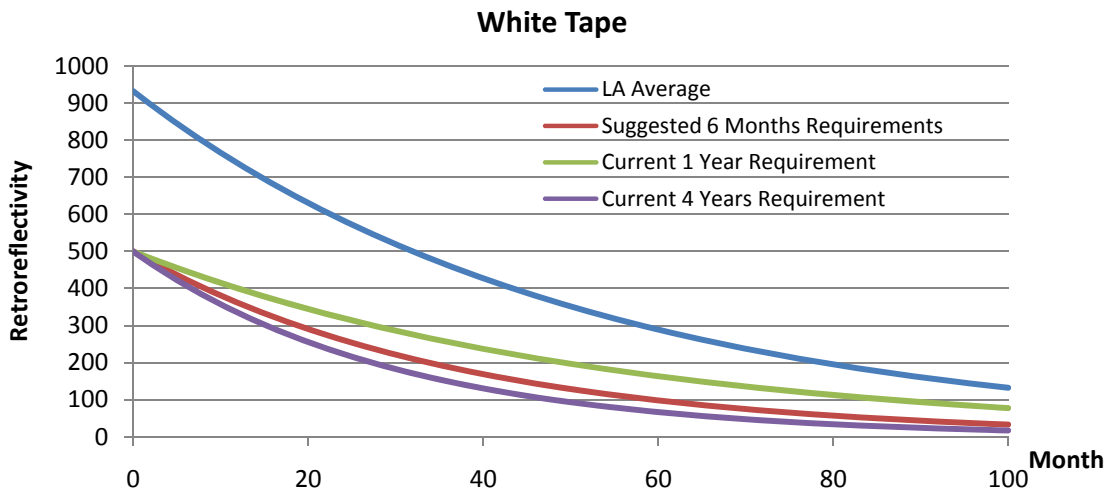

**Figure 41**  
**Average Louisiana tape materials vs. the requirements**

The curve with the suggested six months requirement lies inbetween the two curves with the original one year and four years requirements. On average, tape marking materials used in Louisiana meet the newly suggested requirements. The new six months requirement effectively requires a marking service life of at least 60 months, which is longer than the minimum service life requirement of 48 months in table 17.

The potential of increasing white tape marking service life (measured by month) by raising the initial retroreflectivity requirement can be calculated by the following equations:



$$\Delta month_{min}^{white} = 36.9 * \ln \left( \frac{R_o^{new}}{R_o^{old}} \right), \quad (28)$$

$$\Delta month_{avg}^{white} = 51.3 * \ln \left( \frac{R_o^{new}}{R_o^{old}} \right). \quad (29)$$

The meanings of the variables in the equations are the same as discussed earlier. Figure 42 presents the relationship between the potential new retroreflectivity specifications and the potential increase in marking service life, assuming that the decay rates do not vary with the initial retroreflectivity values.

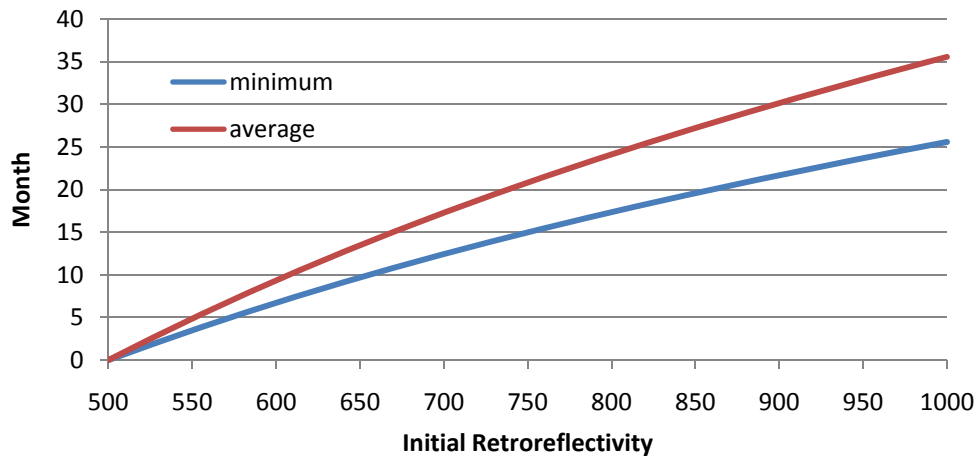

**Figure 42**  
**Potential gain in service life for white tape**

Figure 43 gives the percentage of white tape pavement markings in the data base that would fail both at different initial retroreflectivity levels and at the 180-day 15 percent maximum decrease requirement. Note that the data used to calculate the percentage that would fail at the 7–30 days requirement have a relatively small sample size of 16.

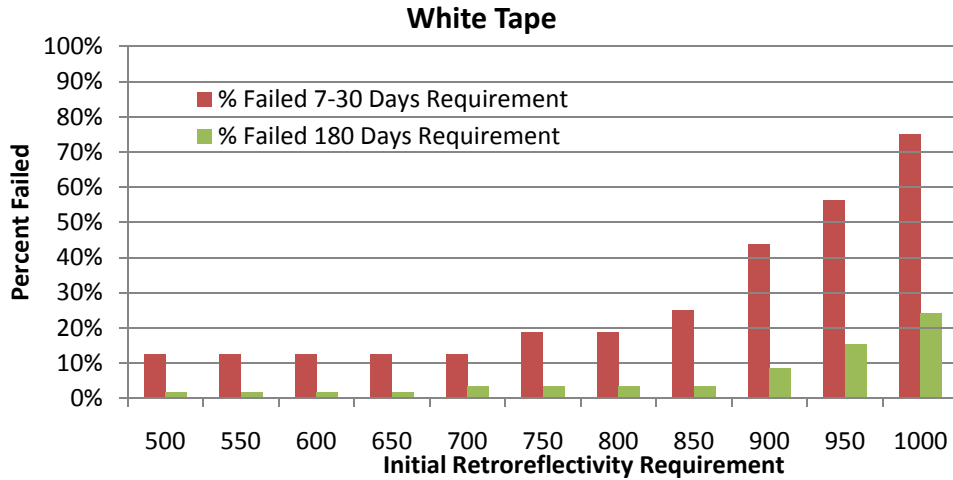

**Figure 43**  
**Percent white tape failure at different initial retroreflectivity requirements**

The results in figure 43 indicate that even if the initial retroreflectivity requirement is raised to 700 mcd/m<sup>2</sup>/lux from 500 mcd/m<sup>2</sup>/lux, which is an increase of 40 percent, the percentage that that would fail the 7–30 days and 180 days requirements would change little. Thus, the white tape pavement materials that satisfy the 500 mcd/m<sup>2</sup>/lux initial retroreflectivity requirement tend to also satisfy the 700 mcd/m<sup>2</sup>/lux initial retroreflectivity requirement. However, higher initial retroreflectivity requirements than 700 mcd/m<sup>2</sup>/lux introduce an increasing failure rate.

The above analysis for both 90 mil and tape shows the pros and cons of raising the retroreflectivity requirements. Users can use the information provided to explore the potential benefit of increasing the current requirements and at the same time understand the potential difficulty of achieving them.

## CONCLUSIONS

Pavement markings need to be restriped from time to time to maintain retroreflectivity. Knowing which material provides the most economically efficient solution is important. Currently, no agreed upon method by which to evaluate the use of alternative pavement marking materials exists. This study developed a methodology that measures the benefit of pavement marking materials based on the public perceived benefit of retroreflectivity. Using the measured benefit along with the cost of installation and impact on road users during the installation process, a benefit/cost analysis is applied to evaluate different marking materials. The data used in this study are from Louisiana interstate freeways. However, the methodology itself can be applied to any highway. Four kinds of pavement materials were evaluated, including thermoplastics (both 40 mil and 90 mil), tape, and inverted profile pavement marker.

A Microsoft Excel spreadsheet workbook with built-in macros was developed for project implementation. A simple and user friendly interface enables the users to select or input basic information about the pavement, traffic conditions, cost, and construction schedule. Results of the analysis are presented in graphical form to assist users in evaluating alternatives and making decisions on what material and construction schedule to select based on the benefit/cost analysis.

This study only takes into account the benefit of pavement marking retroreflectivity to the driving public. Other attributes of pavement markings, such as durability and chromaticity, are not considered. In addition, the benefit from enhanced visibility under wet conditions at night and safety warnings when drivers crossing lines when inverted markings are used are also not included in this study.

The impact of increasing the starting and six-month retroreflectivity specifications for 90 mil and tape were also estimated. Alternative specifications are suggested. Instead of specifying two absolute retroreflectivity requirements in the first and sixth month, specifying an initial retroreflectivity requirement in the first month and then specifying a maximum percent decrease from the initial retroreflectivity in six months is recommended. The recommended system not only sets standards for initial retroreflectivity, but also set limits on the decay rate of retroreflectivity.



## **POTENTIAL PROBLEMS AND RECOMMENDATIONS FOR FUTURE RESEARCH**

The authors believe that the methodology developed in this study is sound. However, the accuracy of the analysis may be compromised by limitations of the data. Several assumptions had to be made because of limitations on data availability or data quality. First, for each type of material, retroreflectivity data were available for only one line type and color, either solid lines or dash lines. As a result, comparisons among different materials by line type and color are impossible unless the assumption is made that retroreflectivity performance is the same for solid and dash lines for the same material and same color. However, there is evidence that this may not be true. For example, the behavior of a 90 mil marking as a white edge (solid) line may be different from that when it is used as a lane (dash) line. Second, four yellow line retroreflectivity models (two for 40 mil and two for tape) had to be developed synthetically (i.e., inferred from the behavior of other models). This was due to lack of data (for tape) or not being able to estimate a reasonable model based on the available data. The accuracy of these synthetic models is yet to be evaluated. Third, within each material type, there are large variations in retroreflectivity performance. Because the retroreflectivity data were collected without product information, this study had to be conducted at the aggregate level of material type. The results reflect the “average” performance of each material. In reality, a specific marking product may behave better or worse than the model predicted average. Last, the data covers only five years of observations, and the longer the years, the fewer the observations. The latter may reduce the model accuracy at lower retroreflectivity values that are critical to evaluate user benefit. Furthermore, many durable marking materials last longer than five years. As a result, when the model predicts pavement markings lasting significantly longer than five years, the validity is yet to be verified.

Based on the above discussion, the following recommendations are suggested for future research:

- For each material, collect marking retroreflectivity data for both solid and dash lines so they can be modeled separately to increase model accuracy.
- Collect retroreflectivity data for yellow tape lines on both PCC and AC. Currently, Louisiana does not use tape for yellow edge lines. However some test lines are recommended to be evaluated so their performances can be evaluated and compared with other materials.
- Collect product specific retroreflectivity data. This will enable us to more accurately evaluate marking material performances.

- Continuously monitor marking performance and collect the retroreflectivity data, especially for durable materials such as tape, so that model performance can be verified or validated.
- As new data become available, update the retroreflectivity performance models to alleviate the potential problems discussed above.

## REFERENCES

1. MUTCD 2000. “*MANUAL on Uniform Traffic Control Devices.*” Federal Highway Administration, Washington, D.C., 2000.
2. Migletz, J. and Graham, J., “Long-Term Pavement Marking Practices: A Synthesis of Highway Practice,” NCHRP Synthesis 306, TRB, 2002.
3. Migletz, J., Graham, J., Harwood, D., Bauer, K., and Sterner, P. *Evaluation of All-Weather Pavement Markings.* Federal Highway Administration, McLean, Virginia, October 2000 (unpublished data).
4. Texas Transportation Institute, “Evaluation Findings of the ECODYN Mobile Pavement Marking Retroreflector, Technical Evaluation Report,” CERF Report 40470, Highway Innovative Technology Evaluation Center, Civil Engineering Research Foundation, Washington, D.C., January 2000.
5. Texas Transportation Institute, “Evaluation Findings of the FRT01 Pavement Marking Retroreflector, Technical Evaluation Report,” CERF Report 40468, Highway Innovative Technology Evaluation Center, Civil Engineering Research Foundation, Washington, D.C., January, 2000.
6. Texas Transportation Institute, “Evaluation Findings of the Laserlux Mobile Pavement Marking Retroreflector, Technical Evaluation Report,” CERF Report 40466, Highway Innovative Technology Evaluation Center, Civil Engineering Research Foundation, Washington, D.C., January 2000.
7. Texas Transportation Institute, “Evaluation Findings of the LTL 2000 Pavement Marking Retroreflector, Technical Evaluation Report,” CERF Report 40469, Highway Innovative Technology Evaluation Center, Civil Engineering Research Foundation, Washington, D.C., January 2000.
8. Texas Transportation Institute, “Evaluation Findings of the Mirolux Plus 30 Pavement Marking Retroreflector, Technical Evaluation Report,” CERF Report 40465, Highway Innovative Technology Evaluation Center, Civil Engineering Research Foundation, Washington, D.C., January 2000.
9. Texas Transportation Institute, “Evaluation Findings of the MX 30 Pavement Marking Retroreflector, Technical Evaluation Report,” CERF Report 40467, Highway Innovative Technology Evaluation Center, Civil Engineering Research Foundation, Washington, D.C., January 2000.

10. Texas Transportation Institute, "Summary of Evaluation Findings for 30 Meter handheld and Mobile Pavement Marking Retroreflectometers," Draft Technical Evaluation Report, Highway Innovative Technology Evaluation Center, Civil Engineering research Foundation, Washington, D.C, March, 2001.
11. Highway Innovative Technology Evaluation Center (HITEC), "Summary of Evaluation Findings for 30-Meter Handheld and Mobile Pavement Marking Retroreflectometers," CERF #40525, 2001.
12. Lindly, J. and Wijesundera, R., "Evaluation of Profiled Pavement Markings," University Transportation Center for Alabama, Report Number 01465, Nov 2003.
13. Turner, J., "Pavement Marking Retroreflectivity: Research Overview and Recommendations," Federal Highway Administration, Office of Safety and Traffic Operations, McLean, VA., December 2, 1998 (unpublished internal report).
14. Migletz, J., Harwood, D., Bauer, K., Rosson, B., and Fish, J. *Field Surveys of Pavement Marking Retroreflectivity*. Report FHWA-RD-99-208, Federal Highway Administration, Washington, D.C., April 2000.
15. Debaillon, C., Carlson, P., He, Y., Schnell, T., and Aktan, Fuat. "Updates to Research on recommended Minimum Levels for Pavement Marking Retroreflectivity to Meet Driver Night Visibility Needs," Federal Highway Administration, No. FHWA-HRT-07-059, October 2007.
16. Loetterle, F., Beck, R., and Carlson, J. "Public Perception of Pavement Marking Brightness." *Transportation Research Record 1715*, Transportation Research Board, Washington, D.C., pp. 51–59, 2000.
17. McGinnis, R. *Pavement Markings Benchmarking*. Commonwealth of Pennsylvania Department of Transportation, October 2001.
18. Cuelho, E., Stephens, J., and McDonald, C. *A Review of the Performance and Cost of Contemporary Pavement Marking Systems*. Final Report for the State of Montana DOT Research Section, February, 2003.
19. Montebello, D. and Schroeder, J. *Cost of Pavement Marking Materials*. Minnesota Department of Transportation, 2000.
20. Kansas Department of Transportation, "*Kansas Department of Transportation Pavement Marking Policy*," Kansas Department of Transportation, January 1999.



21. Gates, J., Najafi, T., Benham, L., Lancaster, P., and Sadeghinia, M. *Effective Pavement Marking Materials and Applications for Portland Cement Concrete Roadways*. FHWA/TX-03/4150-2, Texas Transportation Institute, 2003.
22. Thamizharasan, A., Sarasua, W., Clarke, D., and Davis, W. "A Methodology for Estimating the Lifecycle of Interstate Highway Pavement Marking Retroreflectivity." TRB Paper Number: 03-3867, Washington, D.C., 82ed Transportation Research Board Annual Meeting, 2003.
23. Alabama Department of Transportation (ALDOT). *Profiled Traffic Stripe*. Alabama Department of Transportation, Special Provision No. 02-0107, 2002.
24. North Dakota Department of Transportation (NDDOT). *NDDOT Design Manual*, North Dakota Department of Transportation, 2000.
25. Kansas Department of Transportation, "Kansas Department of Transportation Pavement Marking Policy," Kansas Department of Transportation, January 2002.
26. Migletz, J., Graham, J., Harwood, D., Bauer, K., and Sterner, P. "Service Life of Durable Pavement Markings." *Transportation Research Record 1749*, 2001, pp. 13-21.
27. Dale, J.M. "Pavement Markings: Materials and Application for Extended Service Life," NCHRP Report 138, Transportation Research Board, Washington, D.C., 1988.
28. Perrin, J., Martin, P., and Hansen, B. "A Comprehensive Analysis of Pavement Marking Materials." Presented at 77<sup>th</sup> Annual Meeting of the Transportation Research Board, Washington, D.C., 1998.
29. Andrady, A. *Pavement Marking Materials: Assessing Environment-Friendly Performance*. NCHRP Report 392, Transportation Research Board, Washington, D.C., 1997.
30. Lee, J., Maleck, T., and Taylor, W. "Pavement Marking Material Evaluation Study in Michigan," *ITE Journal*, Vol. 69, No. 7, pp. 44-51, July 1999.
31. Bahar, G., Masliah, M., Erwin, T., Tan, E., and Hauer, E., "Pavement Marking Materials and Markers: Real-World Relationship between Retroreflectivity and Safety over Time," NCHRP Web-Only Document 92: Contractor's Final Report for NCHRP Project 17-28, 2006.
32. Abboud, N. and Bowman, B. "Cost- and Longevity-Based Scheduling of Paint and Thermoplastic Striping," *Transportation Research Record 1794*, Transportation Research Board, Washington, D.C., 2002, pp. 55-62.

33. Abboud, N. and Bowman, B. "Establishing a Crash-Based Retroreflectivity Threshold." Submitted for Presentation at 81st Annual Meeting, Transportation Research Board, Washington, D.C., January 2002.
34. National Transportation Product Evaluation Program (NTPEP), "2004 NTPEP Report Series: NTPEP Report 1021.1," [http://data.ntpep.org/pmm/pmm\\_references.asp?Submittal\\_Year=2002](http://data.ntpep.org/pmm/pmm_references.asp?Submittal_Year=2002), accessed 9/5/2007.
35. National Transportation Product Evaluation Program (NTPEP), "2003 NTPEP Report Series: NTPEP Report 1020.2," [http://data.ntpep.org/pmm/pmm\\_references.asp?Submittal\\_Year=2001](http://data.ntpep.org/pmm/pmm_references.asp?Submittal_Year=2001), accessed 9/5/2007.
36. Federal Highway Administration (FHWA). *Life-Cycle Cost Analysis Primer*. Office of Asset Management, U.S. Department of Transportation, August 2002.
37. Cottrell, B. and Hanson, R. *Determining the Effectiveness of Pavement Marking Materials*. Virginia Transportation Research Council, VTRC 01-R9, February, 2001.
38. Miller, T. "Benefit-Cost Analysis of Lane Marking." *Transportation Research Record 1334*, Transportation Research Board, Washington, D.C., pp. 38-45, 1993.
39. Martin, P., Perrin, J., Jitprasithsiri, S., and Hansen, B., "A Comparative Analysis of the Alternative Pavement Marking Materials for the State of Utah," Presented to Utah Department of Transportation, 1996.
40. Federal Highway Administration (FHWA). *LifeCycle Cost Analysis: RealCost User Manual*. Office of Asset Management, U.S. Department of Transportation, May 2004.
41. Louisiana Department of Transportation and Development (LADOTD). *Life Cycle Cost Analysis: User Manual*, 2007.