

# ***Louisiana Transportation Research Technical Assistance Report***

***Report No. 01-1TA***

**Long Term Performance of Stone  
Interlayer Pavement**

**Pavement/Systems Group  
June 2001**

---

The logo for the Louisiana Transportation Research Center (LTRC) features the letters 'LTRC' in a bold, sans-serif font. Each letter is filled with a horizontal hatching pattern. The letters are positioned above a thick horizontal line that spans the width of the page.

***Louisiana Transportation Research Center***

---

*Sponsored Jointly by the Louisiana Department of Transportation and Development and Louisiana State University*

# Long Term Performance of Stone Interlayer Pavement

Technical Assistance Report Number 01-1TA

By

Masood Rasoulian, P.E.  
Hani Titi, Ph.D., P.E.  
Mark Martinez, EIT  
Byron Becnel, P.E.  
Gary Keel

Louisiana Transportation Research Center  
4101 Gourrier Avenue  
Baton Rouge, LA 70808

Phone: (225) 767-9131  
Fax: (225) 767-9108

State Project Number 201-02-0012  
Junction LA 100 (Evangline) – Junction LA 1123  
Route LA 97  
Acadia Parish

June 2001

## ABSTRACT

This report presents an evaluation of long-term performance of an alternative flexible pavement design referred to here as stone interlayer pavement. This alternative pavement design was introduced to reduce/defer reflective cracking experienced with soil-cement bases. The stone interlayer pavement design consisted of a 102 mm (4-in.) layer of crushed limestone base on top of 152 mm (6 in.) of in-place cement stabilized base. The performance of the stone interlayer pavement was compared to that of the conventional pavement design for state highways other than the interstate system. The conventional pavement design consisted of 216 mm (8.5 in.) of cement stabilized base layer on top of lime treated subgrade. A 99 mm (3.5-in.) layer of hot mix asphalt concrete was placed over both pavement types.

Stone interlayer and conventional pavements were constructed on state highway LA-97 (Acadia Parish) near Jennings, Louisiana. This highway is classified as low volume rural road with an average daily traffic of 2000 vehicles in 1991. Both pavements were monitored for 10 years after construction. During the evaluation period, pavement distress surveys, roughness, permanent deformation, and evaluation of pavement structural capacity using dynamic nondestructive testing were conducted. Additionally, as a part of the Louisiana Transportation Research Center (LTRC) accelerated pavement testing research program, both pavement designs were tested to failure under the Accelerated Loading Facility (ALF).

The results of this investigation showed that the alternative stone interlayer pavement significantly reduced the amount of reflective cracking. The surface roughness measurements and pavement serviceability showed that the performance of the stone interlayer is slightly better than that of the conventional pavement. The structural capacity and rutting measured for both pavement types were similar during the evaluation period. On another scale, the accelerated testing results also verified the superior performance of stone interlayer pavement system. The cost analysis showed that the initial material cost of stone interlayer system might be as high as 20 percent more than that of the conventional pavement design. However, the stone interlayer pavement system showed superior performance over the standard soil cement pavement as tested under accelerated loading.

## ACKNOWLEDGMENTS

The Pavements Systems Research Group within LTRC conducted this research as a technical assistance project. The authors would like to acknowledge Mitchell Terrell, Shawn Elisar, and Glen Gore for their significant help in completing this project. The authors also extend their appreciation to Bill King, Keith Gillespie, and George Crosby, Louisiana State University, for their diligence with the accelerated pavement testing operations. The assistance of J.B. Esnard, former DOTD Geotechnical and Pavement Administrator, is acknowledged in scheduling a plan change to set up this project.

## TABLE OF CONTENTS

Abstract .....	ii
Acknowledgments .....	iii
List of Tables .....	v
List of Figures .....	vi
Introduction .....	1
Background .....	1
Objective and Scope .....	4
Methodology .....	5
Project Description .....	5
Long Term Pavement Performance Monitoring Program .....	5
Pavement Distress Survey .....	5
Nondestructive Evaluation of Pavement Structure .....	9
Evaluation of Pavement Roughness and Deformation .....	9
Accelerated Pavement Testing .....	11
Discussion of Results .....	13
Traffic Loading and Environmental Conditions .....	13
Evaluation of Pavement Performance .....	13
Pavement Cracking .....	13
Structural Capacity .....	15
Pavement Roughness and Permanent Deformation .....	23
Pavement Performance Under Accelerated Loading .....	23
Cost Analysis .....	26
Conclusions .....	27
Recommendations .....	28
References .....	29

## LIST OF TABLES

Table 1: Long-term performance monitoring schedule .....	8
Table 2: Nondestructive evaluation of pavement layer during construction .....	20
Table 3: Results of accelerated loading tests on the conventional and the stone interlayer pavement .....	25

## LIST OF FIGURES

Figure 1: Mechanism of development of reflective cracking in conventional pavements with soil-cement base, and the role of stone interlayer in delaying the time and rate of reflective cracking development .....	3
Figure 2: Location of the project on State Highway LA-97 near Jennings, Louisiana .....	6
Figure 3: Location and configuration of the conventional and stone interlayer pavement test sections .....	7
Figure 4: Picture of the Accelerated Loading Facility (ALF) located at the LTRC Pavement Research Facility test site, Port Allen, Louisiana .....	12
Figure 5: Traffic loading characteristics for state highway LA-97 .....	14
Figure 6: Pictures of the cracks developed at the investigated pavement section .....	16
Figure 7: Results of distress survey conducted on the conventional and the stone interlayer pavement 10 years after construction .....	17
Figure 8: Cracking of the conventional pavement (a, b, and c) and the stone interlayer pavement (d, e, and f) after 10.2 years from construction (most cracking is low severity, M denotes medium severity, S denotes high severity according to SHRP (1993) manual .....	18
Figure 9: Comparison of structural capacity performance of the conventional and stone interlayer pavements over a 10-year period .....	21
Figure 10: Comparison of resilient modulus of subgrade soil for the conventional and stone interlayer pavements over a 10-year period .....	22
Figure 11: Comparison of ride quality of the conventional and stone interlayer pavements over 1 10-year period .....	24





## INTRODUCTION

Soft and saturated subgrade soils are a common occurrence in Louisiana, especially in the southern part of the state. Such subgrade soils are not structurally competent to support pavements and their traffic loading. To overcome this problem, the Louisiana Department of Transportation and Development (DOTD) has adopted a conventional pavement design method for flexible pavements on state highways other than the interstate system. The design consists of lime treatment of subgrade soil (sub base layer), and in-place cement stabilization of soil (soil-cement base layer), and hot mix asphalt concrete (HMAC) surface layer. This pavement design method, with strong soil-cement base, has the advantage of producing pavements that are structurally capable of supporting traffic loading under weak subgrade support. In addition, the construction of pavements with soil-cement base layers is quick and cost effective. While the use of soil-cement base layers effectively improves the structural capacity of flexible pavements, it is the major cause of reflective cracking, which accelerates pavement deterioration and decreases pavement life.

Researchers at the Louisiana Transportation Research Center (LTRC) have focused their effort on innovative alternative methodologies to reduce reflective cracking and improve the long-term performance of flexible pavements in Louisiana. Among these methods is the use of granular materials (such as crushed limestone) between the soil-cement base and the HMAC surface layer. This pavement type is denoted herein as the stone interlayer pavement. This report describes a research effort conducted at LTRC to evaluate the long-term performance of stone interlayer pavement design and to assess the capability of the stone interlayer to reduce reflective cracking in flexible pavements. Two flexible pavement sections were designed and constructed on State Highway LA-97 near Jennings in Acadia Parish, Louisiana in 1991. The first section consisted of conventional pavement design (soil-cement base) and the second section consisted of stone interlayer pavement design (crushed limestone over soil-cement base). The latter design is also referred to as the inverted pavement design. The performance of the two pavements was monitored over a period of ten years. Pavement distress surveys, evaluation of structural capacity of the pavements, measurement of permanent deformation, and evaluation of pavement roughness and serviceability were conducted in a systematic way. In addition, the conventional and the alternative stone interlayer pavements were tested under accelerated loading conditions at the Pavement Research Facility. Test results confirmed the superior performance of the alternative stone interlayer pavement.

### Background

Soil-cement has long been used as engineered material in various applications including base layers in pavements with weak subgrade soil. In addition, the use of soil-cement is cost effective in areas lacking aggregate resources. These conditions make southern Louisiana a perfect candidate for pavements with soil-cement bases. Indeed, Louisiana has thousands of highway miles with soil-cement bases, some of which have been in service for more than 40 years. The use of soil-cement base course layers effectively

improved the structural capacity of pavements built on weak subgrade soils, and minimized localized failure and permanent deformation. However, there is a cracking problem associated with the use of soil-cement bases on flexible pavements.

The behavior of soil-cement mixture during hydration varies, depending on many factors including soil type, mineralogical composition, moisture content, density, and cement content. These factors control the development of shrinkage cracking within the soil-cement base during hydration. Shrinkage cracking, resulting from tensile stresses during hydration of soil-cement mixtures, usually extends to the pavement surface in the form of reflective block cracks. Figure 1a shows the mechanism in which shrinkage cracking is reflected to pavement surface. Since reflective cracks are extended from the soil-cement base to the surface, the pavement will be vulnerable to deterioration. Rainfall infiltration through cracks combined with repeated traffic loading will cause washout of underlying materials through a pumping action. Loss of pavement base support usually results in rapid pavement deterioration in terms of localized failure zones, settlement of pavement surface, cracks, and potholes. These pavement conditions shorten the life of the roadway. Therefore, it is necessary to improve the flexible pavement design to reduce/defer (if possible to eliminate) the propagation of soil-cement cracks into the surface layer.

Research efforts at LTRC were concentrated on economical alternative pavement designs to reduce reflective cracking and improve the long-term performance of flexible pavements in Louisiana. The introduction of an interlayer between the soil-cement base and the HMAC surface layer to absorb tensile shrinkage stresses is among other options used. As shown in Figure 1b, tensile stresses developed within the soil-cement mass will be absorbed by the stone particles through their small dilative movement. The magnitude of tensile stresses will be drastically minimized at the interface between the stone interlayer and the HMAC surface. This is expected to reduce the amount of reflective cracking.

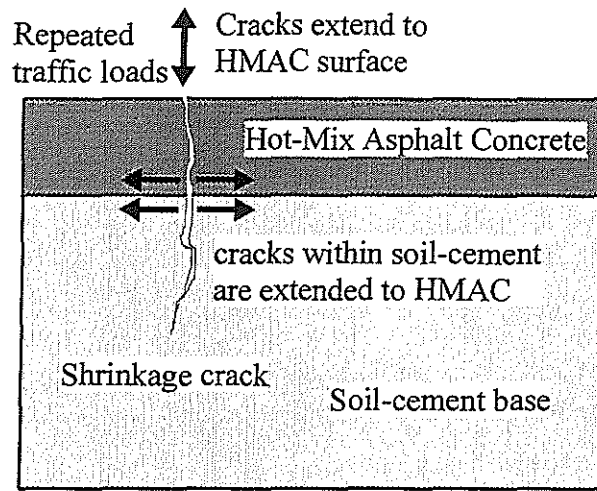

(a) Development of shrinkage cracking within soil-cement base and the subsequent extension to the HMAC surface layer

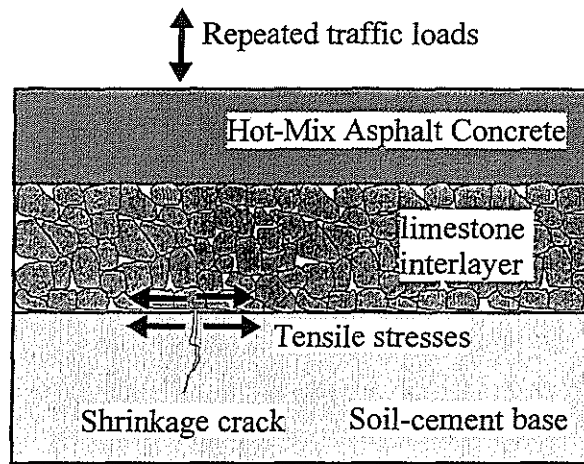

(b) Introducing limestone interlayer creates a separation medium between soil-cement base and the HMAC surface layer, which effectively reduces reflective cracking due to “*absorption*” of tensile stresses by limestone particles.

Figure 1: Mechanism of development of reflective cracking in conventional pavements with soil-cement base, and the role of stone interlayer in delaying the time and rate of reflective cracking development.

## OBJECTIVE AND SCOPE

The objective of this research is to determine the effectiveness of using the stone interlayer pavement design by comparing the long-term pavement performance of the stone interlayer pavement design with that of the conventional pavement design. The scope of this research was to monitor the performance of the conventional and the stone interlayer pavements constructed on LA 97 by measuring pavement distresses and pavement condition over a period of ten years. The pavement distresses measured were pavement cracking and rutting. The quantity, severity, and patterns of cracking were examined. The pavement conditions measured were structural capacity and roughness. The results of this research were compared with the results of experiments conducted at the Pavement Research Facility site.

## **METHODOLOGY**

### **Project Description**

A research study was initiated to investigate the effect of crushed limestone interlayer in effectively reducing/deferring cracks from reflecting to the flexible pavement surface. The plan was to establish two test sections to compare the performance of the stone interlayer pavement design and the conventional pavement design. The research was conducted on State Route LA-97 near Jennings, Acadia Parish, Louisiana. The LA-97 project extends from Junction LA-100 to Junction LA-1123. Location of the project on highway LA-97 is shown in Figure 2. This portion of highway LA-97 is classified as a rural collector highway with an average daily traffic (ADT) of 2,000 vehicles in 1990. LA-97 is a low volume rural highway with two 7.3-m (24-ft) travel lanes.

The project consisted of new construction of 7.56 km (4.7 miles) flexible pavement highway with two 7.3-m (24-ft) travel lanes. The two test sections selected on the project are test section #1, which is the conventional pavement (soil-cement base) design, and test section #2 which is the limestone interlayer design. Each section is 322 m (1056 ft) long. Figure 3a shows the two test sections and the corresponding station numbers.

The original design (Figure 3b) was to construct a 216 mm (8.5 in.) in-place cement stabilized base course layer and 89 mm (3.5 in.) HMAC surface layer (38 mm (1.5 in.) asphaltic concrete wearing course and 51 mm (2 in.) asphaltic concrete binder course). A change of plan was initiated to investigate the effect of adding a crushed limestone base interlayer to minimize reflective cracks. Therefore, a 1.61 km (1 mile) section of the highway was constructed with 152 mm (6 in.) in-place cement stabilized base course layer, 102 mm (4 in.) crushed limestone interlayer, and 89 mm (3.5) HMAC surface layer (38 mm (1.5 in.) asphaltic concrete wearing course and 51 mm (2 in.) asphaltic concrete binder course). The pavement cross section of limestone interlayer pavement is shown in Figure 3c. Both pavement designs were constructed on 305 mm (12 in.) lime treated subgrade soil (subbase layer) to provide stability and support for the pavement structure.

### **Long Term Pavement Performance Monitoring Program**

#### **Pavement Distress Survey**

The Pavement Systems Research Group at LTRC conducted periodic pavement distress surveys over a ten-year period (Table 1). The surveys consisted of visually inspecting the pavement sections and recording the pavement distresses and any other unusual observations within the pavement structure. Surveyed pavement distresses included longitudinal and transverse cracks. In addition, pavement sections were surveyed for raveling, shoving, and potholes. The severity level and patterns for cracks and other distresses were determined according to the Distress Identification Manual for the Long-Term Pavement Performance Project (SHRP, 1993).

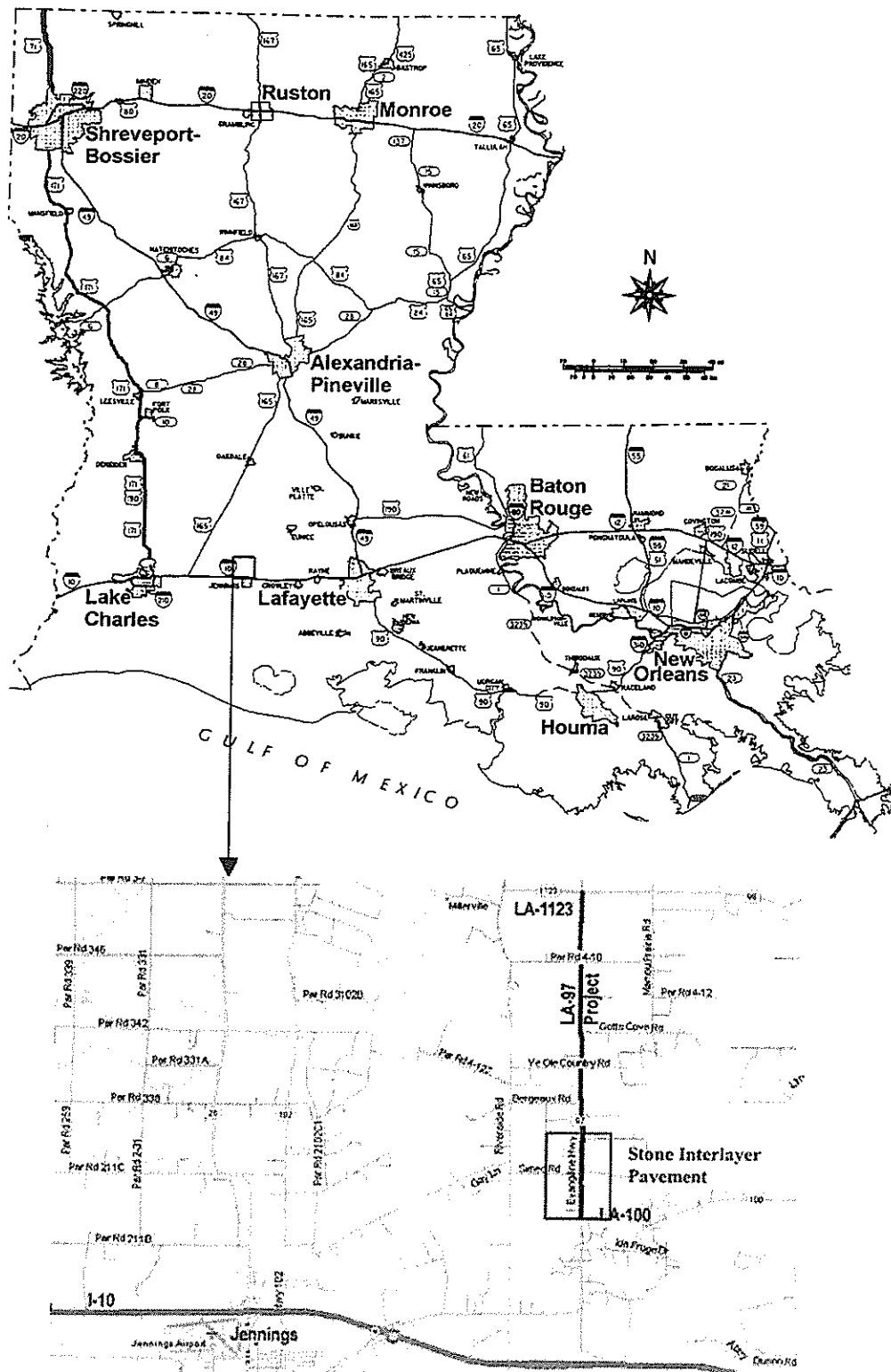
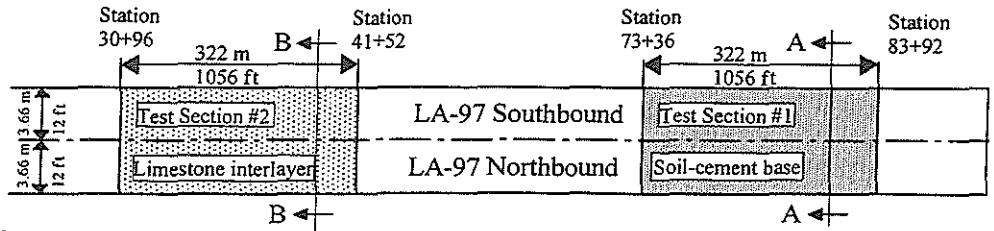
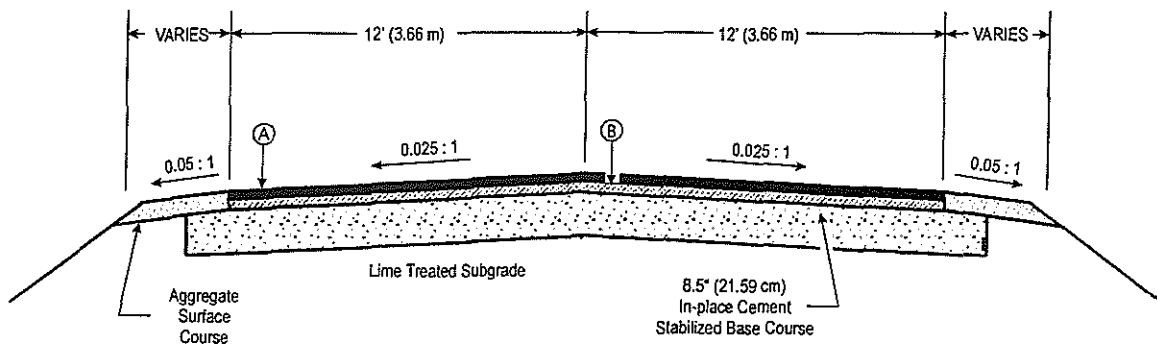

Figure 2: Location of the project on State Highway LA-97 near Jennings, Louisiana.



Panel Length, m (ft)	Cracking Sampling Panels	
	Test Section #1 (From Station to Station) (ft)	Test Section #2 (From Station to Station) (ft)
30 (100)	73+36 74+36	30+96 31+96
30 (100)	77+86 78+86	35+34 36+34
30 (100)	82+36 83+36	39+84 40+84

(a) Pavement test section and areas of crack sampling



(b) Typical section (A-A) of the conventional pavement (soil-cement base)

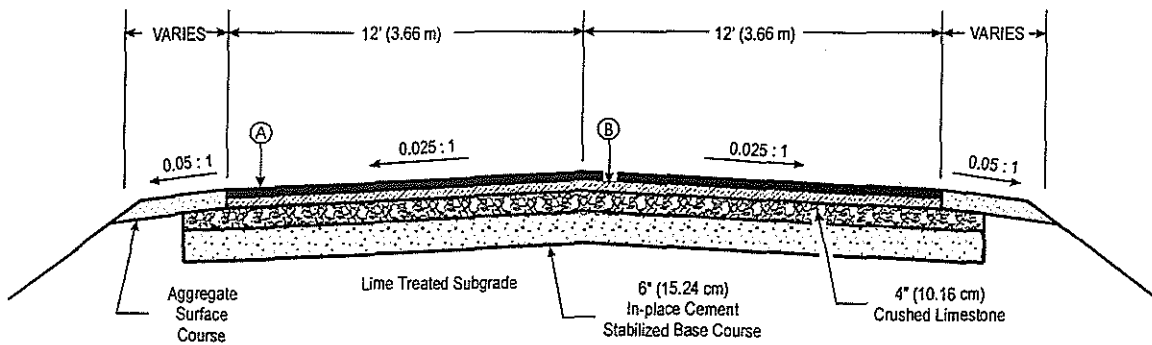

(A) 1.5 in (3.81 cm) HMAC type 3 wearing course

(B) 2.0 in (5.08 cm) HMAC type 3 binder course

(c) Typical section (B-B) of the stone interlayer pavement

Figure 3: Location and configuration of the conventional and stone interlayer pavement test sections.

TABLE – 1: Long-term performance monitoring schedule.

Test Date	Time after construction		Pavement Testing and Monitoring		
	Month	Year	Pavement distress survey	NDT – Structural Capacity	Pavement Roughness and Rutting
March 1991	1	0.08	–	✓	✓
August 1991	6	0.50	–	✓	–
December 1991	10	0.83	✓	–	✓
October 1992	20	1.67	✓	–	✓
March 1993	25	2.08	–	✓	–
September 1993	31	2.58	–	–	✓
February 1995	48	4.00	✓	✓	–
May 1995	51	4.25	–	–	✓
September 1996	67	5.58	✓	✓	–
May 1998	87	7.25	–	–	✓
July 1998	89	7.42	✓	–	–
April 2001	122	10.17	✓	✓	✓



The pavement surface cracking surveys were conducted by mapping the longitudinal and transverse cracks on a paper. The distance from the beginning to the end of the crack was measured to determine the length of the crack.

### Nondestructive Evaluation of Pavement Structure

As presented in Table 1, nondestructive pavement testing (NDT) and evaluation of the test sections was conducted six times over the past 10 years. The NDT consisted of measurements of pavement deflection due to induced dynamic load using the Dynamic Deflection Determination System (Dynalect). This system is a nondestructive testing device that induces dynamic load on the pavement surface and measures the corresponding deformation at different locations. The maximum dynamic load, about 4.448 kN (1,000 lb), is induced due to counter-eccentric rotation of two masses at frequency of 8 Hz. The load is transmitted to the pavement through two steel wheels. The deformation is recorded by a set of 5 geophones installed on a beam and spaced at 305 mm (12 in.), with the first geophone is placed between the two steel wheels.

Kinchen and Temple (1980) developed a mechanistic approach for design of HMAC overlays based on deflection analysis. The methodology was proposed and verified based on comprehensive evaluation of the structural capacity of Louisiana pavements using the Dynalect nondestructive testing system. For more than 20 years, DOTD has been using this methodology for pavement evaluation and design. This method was used in the current study to evaluate the structural capacity of the investigated pavements.

A series of nondestructive testing was conducted during the different stages of the pavement construction. This was to evaluate the strength of the individual pavement layers. The first set of nondestructive tests was conducted on the 305 mm (12 in.) lime-stabilized sub base for both test sections #1 and #2. Then the second set of testing was conducted after construction of 216 mm (8.5 in.) soil-cement for test section #1 and 152 mm (6 in.) soil cement for test #2. The third set was conducted only on test section #2 after the construction of the 102 mm (4 in.) crushed limestone interlayer. The final set was conducted after construction of the 89 mm (3.5 in.) HMAC surface layer. Tests were conducted on each section on 30 m (100 ft) intervals.

### Evaluation of Pavement Roughness and Deformation

Field tests were conducted to determine the ride quality and permanent deformation (rutting) of the investigated pavements. As presented in Table 1, field-testing was conducted seven times during the last ten years. From 1991 to 1995, the Mays Ride Meter (MRM) was used to evaluate pavement roughness and the AASHTO A-frame was used to measure pavement rutting. After 1995, the high-speed road profiler was used to evaluate pavement roughness and rutting. A description of the test equipment is given below.

### *Mays Ride Meter*

The Mays Ride Meter is equipment that measures road roughness consisting of recorder, photoelectric transmitter, and a special odometer. It is designed to operate in a vehicle with a traveling speed of 80 km/hour (50 mph). MRM records travel distance the actual road profile on continuous feed chart paper. Based on the relative movement of the car axle with respect to the vehicle body, the photocell transmitter converts the accepted light rays into electrical impulses that are converted into profile on the chart. Special charts are developed for interpretation road roughness using MRM test results. The MRM test results are expressed in terms of the Present Serviceability Index (PSI).

Field-testing using the MRM was conducted five times on the entire test section to ensure repeatability of test results. The MRM test results for the test sections were expressed in terms of PSI. In addition, PSI values were converted into the International Roughness Index (IRI) using the correlation established by the World Bank (1986).

### *High-Speed Road Profiler*

The high-speed road profiler is a vehicle equipped with three laser sensor for height measurements, one sensor to measure travel distance, and two accelerometers to account for vehicle vibrations. The accelerometers allow the system to function independently of the vehicle characteristics and travel speed. The system is capable of collecting road profile data at a minimum distance interval of 76.2 mm (3.0 in).

The LTRC high-speed road profiler was used to collect pavement surface data for evaluation of roughness and rutting. Longitudinal profiles of the test sections were measured by conducting three to five runs on the entire test section to ensure repeatability of the test results. The profile of each wheel path was obtained, and the pavement roughness was determined in terms of IRI. The average IRI from both wheel paths was used to evaluate each pavement type.

The mean rut depth was also determined from the laser sensors height measurements. Verification of rut depth was also made using the AASHTO A-frame. The mean rut depth of the entire test section (the outside wheel path) was used in the analysis and evaluation of the test sections.

## Accelerated Pavement Testing

LTRC has established the Pavement Research Facility test site in Port Allen, Louisiana to bridge the gap between laboratory characterization and field performance of pavements under heavy loading conditions. The site houses the Louisiana Accelerated Loading Facility (ALF), the second of its kind in the U.S. Shown in Figure 4, ALF is a 30.5-m (100 ft) long, 489-kN (55 ton), accelerated loading device used to simulate and accelerate truck loads for pavement testing. The ALF device is a transportable, linear, full-scale accelerated loading facility, which imposes a rolling wheel load on a 1.2 X 12 m (4X39 ft) area test pavement. Loading is applied in one direction only, at a constant speed of 16.7 km/hr (10.4 mph). Each loading cycle takes eight seconds and is applied through a standard dual tire truck capable of loads between 43 kN (9,750 lb) and 84 kN (18,950 lb). This indicates that for each pass 1.38 to 19.7 ESALs is applied to the pavement. This allows the ALF to traffic a test pavement at up to 8,100 wheel passes (11,200 to 160,000 ESALS) per day. The ALF device, by increasing the magnitude of the load and running the device for 24 hours a day, can compress many years of road wear into just a few months of testing.

The PRF site is located on six acres of soft saturated heavy clay (CH) with 84% clay and 14% silt. A 1.52 m thick embankment was constructed of silty clay (CL-ML) with 23% clay and 70% silt to investigate the performance of flexible pavements under accelerated loading conditions. The results from the accelerated loading tests on conventional and stone interlayer pavement are examined. Two test lanes (designated 008 and 009) at the facility have the same surface course and base course as that of the pavements constructed at highway LA-97. These lanes were tested to failure by the Accelerated Loading Facility.

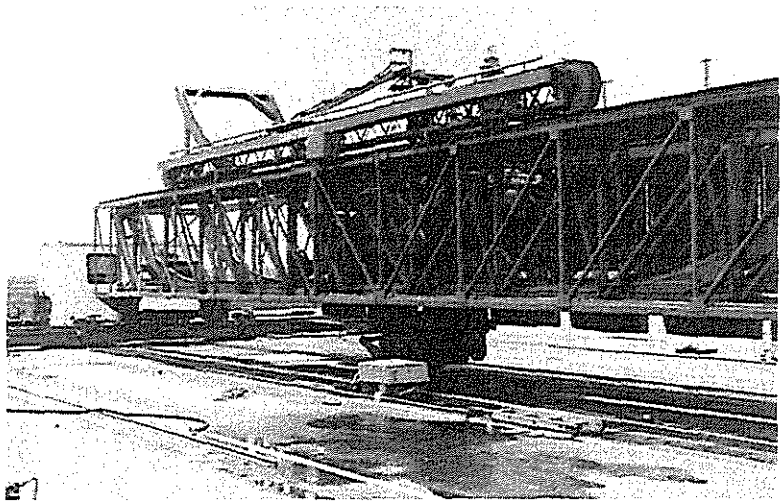

Figure 4: Picture of the Accelerated Loading Facility (ALF) located at the LTRC Pavement Research Facility test site, Port Allen, Louisiana.

## **DISCUSSION OF RESULTS**

Evaluation of pavement performance is a difficult task due to the complex nature of the variables controlling the behavior of pavements. Among these factors are the pavement material characteristics, properties of subgrade soil, pavement construction process, environmental conditions, and traffic loadings. In this section, the long-term performance of the investigated pavements will be analyzed with consideration of these factors.

### **Traffic Loading and Environmental Conditions**

The research project was conducted on the state highway LA-97, which is classified as a rural collector highway. The average daily traffic on LA-97 was 2,000 vehicles in 1990. It is important to base the analysis on field data in order to make valid comparisons and conclusions. Therefore, history ADT data were obtained from DOTD files and analyzed to evaluate the long-term performance of the investigated pavement types. As shown in Figure 5a, the actual ADT data was used to predict future ADT using simple linear and power regression analysis. The AASHTO design guide (1993) indicated that traffic on some minor arterial or collector-type highways tends to increase along a straight line.

The traffic over a performance period of 15 years was used to determine the Equivalent Single Axle Load (ESAL). As shown in Figure 5b, the pavement loading in terms of ESALs was determined every year during the performance period. This data are important to estimate the remaining life of the pavement and to make valid comparisons with the accelerated loading tests conducted at the PRF on similar pavement type.

The project is located in the southern part of Louisiana. Farms and crawfish ponds are located along highway LA-97. Ditches around the highway are usually full of water, indicating a saturated subgrade soil. In the project area, the average air temperature changes from low to high vary between  $-1.1$  and  $37.8$  C°. The average pavement surface temperature can be as high as  $62.8$  C° ( $145$  F°) during summer. The average annual rainfall is about 1,524 mm (60 in.).

### **Evaluation of the Pavement Performance**

#### **Pavement Cracking**

Pavement distress surveys conducted over a period of 10 years have shown no evidence of shoving, raveling, or potholes on both investigated pavements. However, as shown in Figure 6, cracking was developed within both investigated pavements. Figure 7 presents the results of cracking surveys conducted over the 10-year period of pavement monitoring program. As shown in Figure 7a, it took 4 years for a total of 4.27 m (14 ft) of low severity level cracking to develop within the stone interlayer pavement. This is compared to 154.53 m (507 ft) of low and medium severity level cracking developed within the conventional pavement. Inspection of Figure 7 shows that there is a progressive increase in cracking with time in both pavement types, but with a drastically

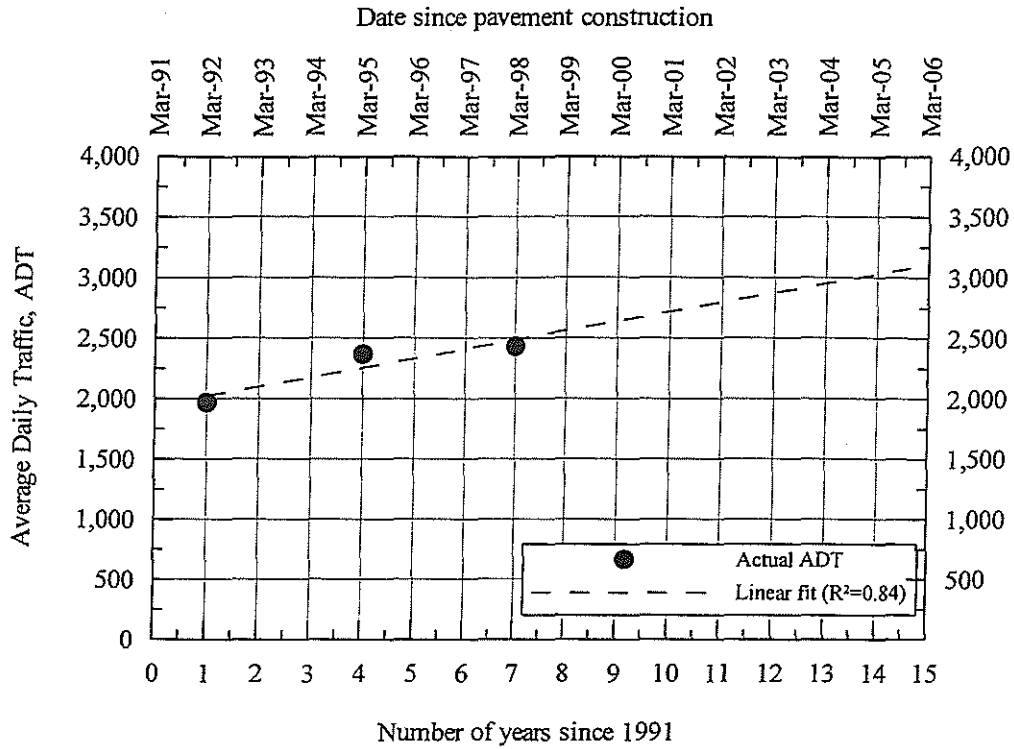

(a) Actual and predicted average daily traffic over a performance period of 15 years for highway LA-97.

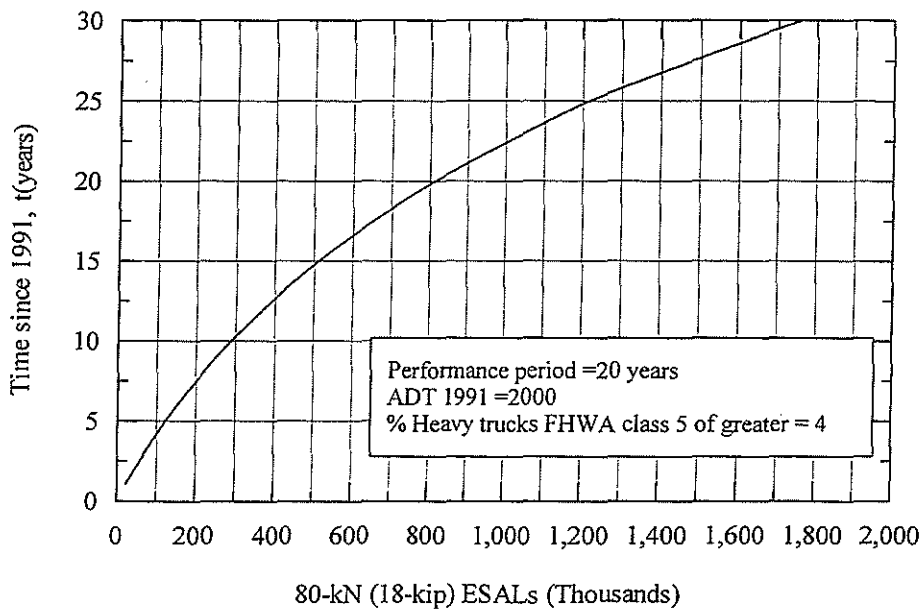

(b) Traffic loading on LA-97 over a performance period of 15 years.

Figure 5: Traffic loading characteristics for state highway LA-97.

lower rate in the case of the stone interlayer pavement. The pattern of cracking within the conventional pavement area was 65 percent transverse and 35 percent longitudinal. The pattern of cracking within the stone interlayer pavement area was 36 percent transverse and 64 percent longitudinal.

The latest pavement cracking survey, conducted 10.2 years after construction, showed that cracking quantity and severity levels developed within the conventional pavement (soil-cement) base is greater than that developed within the stone interlayer pavement. The total cracking length developed within the surveyed panels of the conventional pavement is 232.81 m (764 ft) in which 151.8 m (498 ft) has low severity level, 64 m (210 ft) has medium severity level, and 17.1 m (56 ft) has high severity level. The stone interlayer pavement showed less cracking with a total length of 118.3 m (388 ft) in which 94.5 m (310 ft) has low severity level and 23.8 m (78 ft) has medium severity level. No cracking of high severity level was observed within the stone interlayer pavement.

The cracking density is used as a criterion to evaluate pavement deterioration and failure. At LTRC, the cracking density of  $4.92 \text{ m/m}^2$  ( $1.5 \text{ ft/ft}^2$ ) is used as a failure criterion for pavements tested under accelerated conditions. Figure 7b shows the variation of cracking density versus traffic loading on the investigated pavements. The cracking density for the stone interlayer pavement after 10.2 years of service is  $0.177 \text{ m/m}^2$  ( $0.053 \text{ ft/ft}^2$ ), which is only 3.6% of the failure criterion limit. This is corresponding to traffic loading of 296,667 ESALs. The conventional pavement cracking density after 10.2 years is  $0.348 \text{ m/m}^2$  ( $0.106 \text{ ft/ft}^2$ ), which is 7.1% of the failure criterion limit.

A cracking map for the conventional and stone interlayer pavements is depicted in Figure 8. The results are from the latest pavement distress survey conducted in 2001. The figure shows that the stone interlayer base was very effective in reducing cracks from reflecting to the pavement surface. Cracking patterns and characteristics suggest that these are block reflective cracks. There is very little evidence of fatigue cracking within the investigated pavement panels.

Pavement distress surveys showed that the stone interlayer base effectively reduced/deferred the starting time as well as the rate of reflective cracking development.

### Structural Capacity

It is essential to design pavements that are capable of supporting traffic loading under certain environmental conditions. The structural number (SN) is a measure of the pavement capacity to support traffic loading. Design of flexible pavements is usually conducted following the 1993 AASHTO design guide procedure. In this procedure, input parameters are required to determine the structural number of the pavement. These input parameters include the estimated traffic, initial and terminal serviceability, overall standard deviation, reliability level, and resilient modulus of subgrade soil. The thickness of the different pavement layers can then be determined by satisfying the following equation:

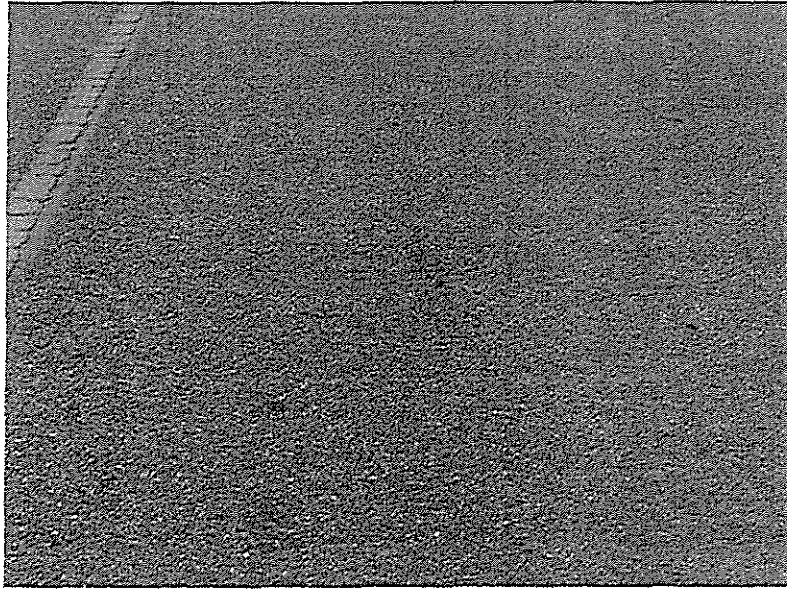

(a) Low severity level longitudinal cracks within the Stone interlayer pavement section

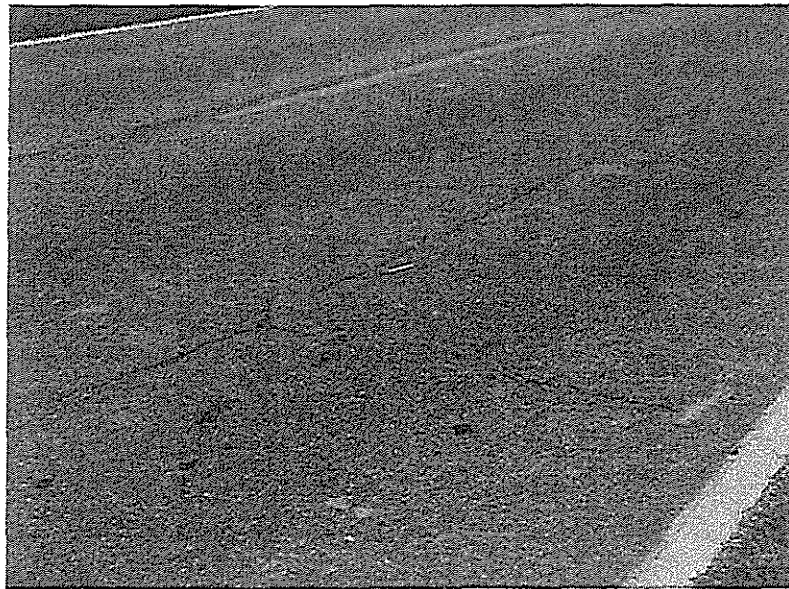

(b) Block cracks within the conventional pavement section (soil-cement base)

Figure 6: Pictures of the cracks developed at the investigated pavement section.



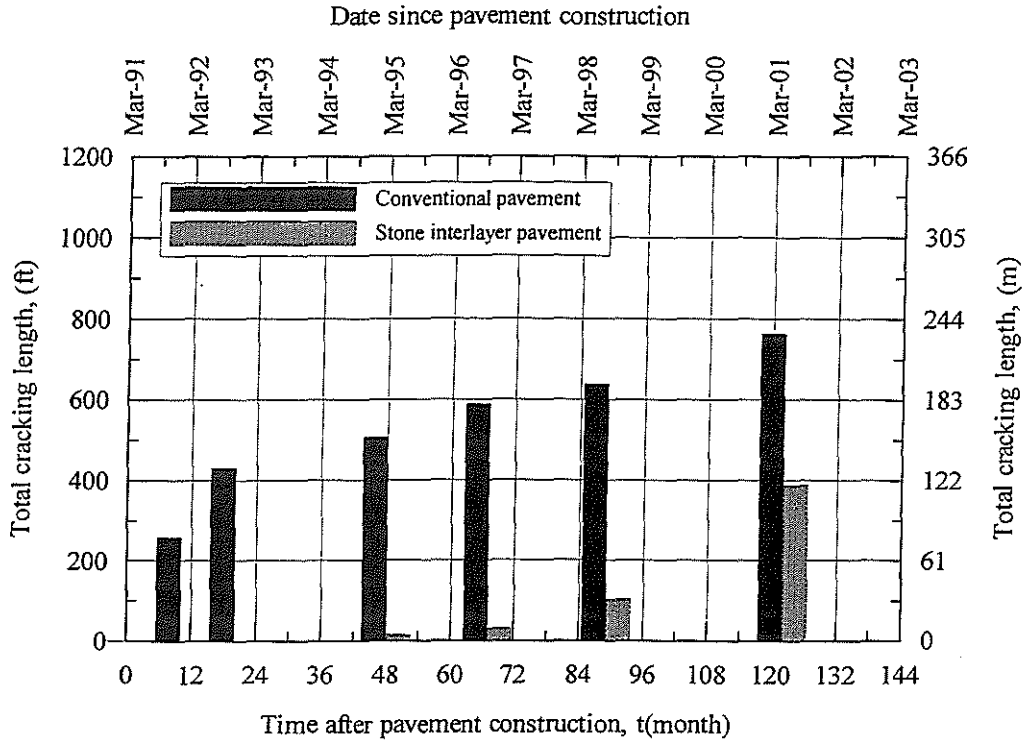

(a) Total cracking developed within both pavement types over a period of 10 years after construction.

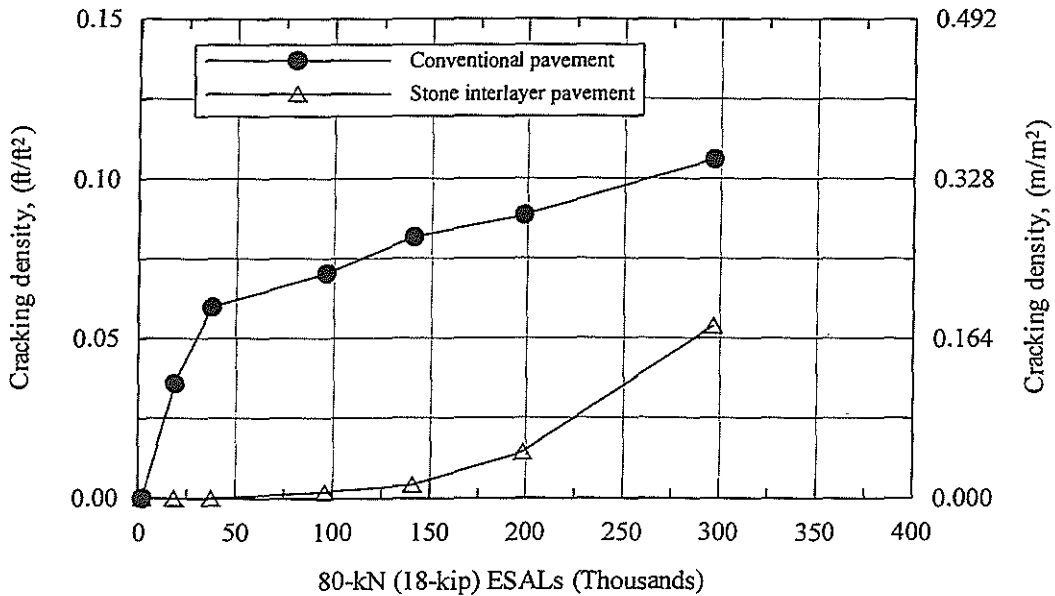

(b) Cracking density versus traffic loading for the investigated pavement over a period of 10 years after construction.

Figure 7: Results of distress survey conducted on the conventional and the stone interlayer pavement 10 years after construction.

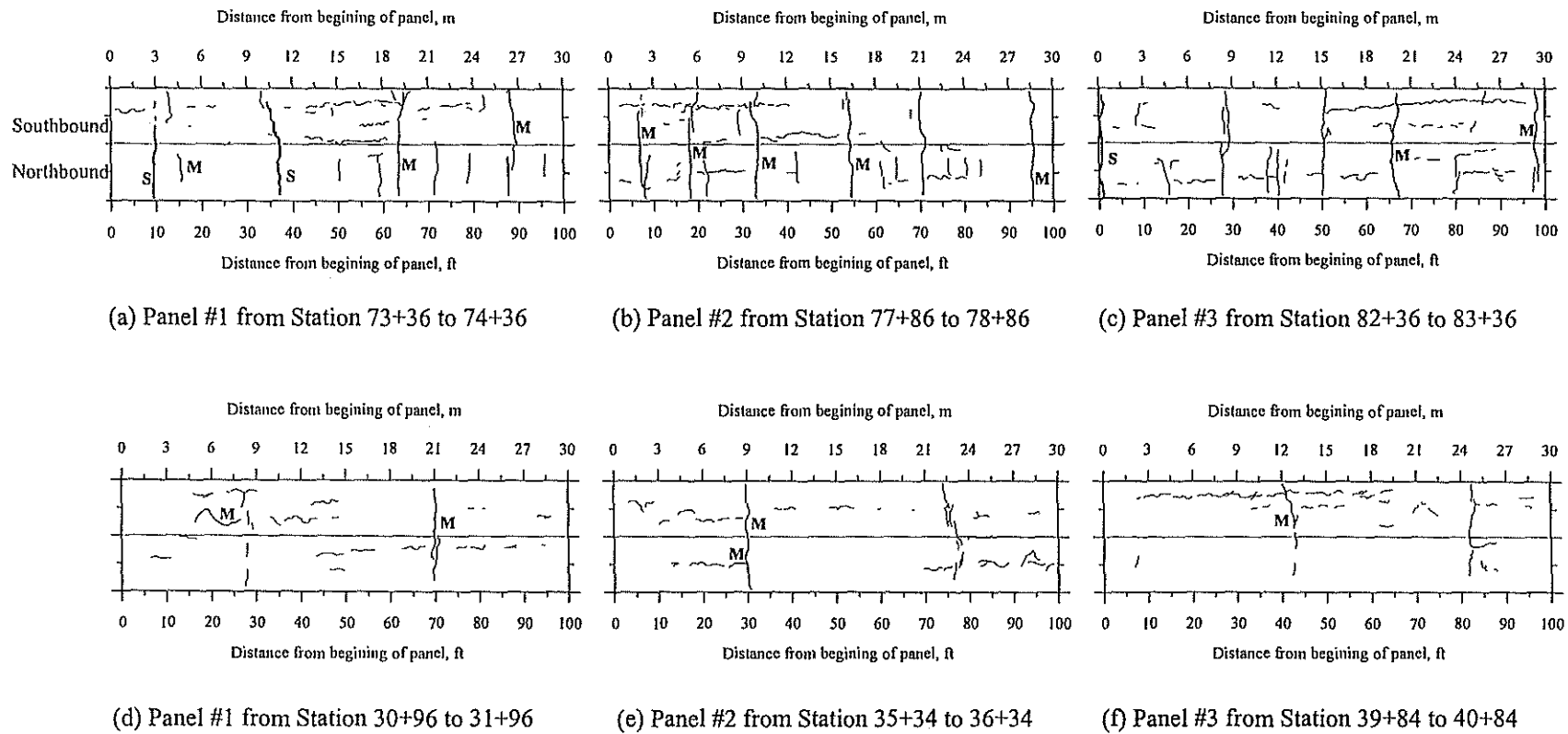

Figure 8: Cracking of the conventional pavement (a, b, and c) and the stone interlayer pavement (d, e, and f) after 10.2 years from construction (most cracking is low severity, M denotes medium severity, S denotes high severity according to SHRP (1993) manual).

$$SN = a_1 D_1 + \sum_{i=2}^n a_i D_i m_i$$

where SN is the structural number,  $a_i$  is structural layer coefficient,  $D_i$  is the layer thickness, and  $m_i$  is the layer drainage coefficient. These input parameters depend on the material characteristics and vary depending on local experience. The structural layer coefficients used by DOTD for the materials used in both pavements are as follows: 0.42/in. for the HMAC surface layer, 0.14/in. for soil-cement base course layer, 0.14/in. for crushed limestone base course layer, and 0.07/in. for lime treated subgrade soil. The drainage coefficient was assumed 1.0 for all layers. Equation 1 was used to calculate the design structural number for both pavement types. The design SN for the conventional pavement is 3.86 and design SN for the stone interlayer pavement is 4.07.

The results of the nondestructive testing and evaluation of the pavements since the beginning of the pavement construction are summarized in Table 2. These values represent the mean for each pavement type. Figure 9 presents the results of long-term nondestructive testing on the investigated pavement after construction of the HMAC surface layer. As shown in Figure 9a, SN ranges from 4.2 to 7.1 for the conventional pavement and from 4.1 to 7.2 for the stone interlayer pavement. The minimum SN determined from NDT evaluation is higher than the design SN calculated using Equation 1 for both pavement types. The relationship of mean SN to traffic loading is depicted in Figure 9b. On average, the conventional and the stone interlayer pavement showed similar structural capacity.

The resilient modulus of the subgrade soil was also evaluated using NDT. Figure 10a presents the variation of the resilient modulus of subgrade soil with time for both pavement types. For the 10-year evaluation period, the resilient modulus varied within the same section ranging from 57.9 to 172.4 MPa (8.4 to 25 ksi) for the conventional pavement and 61.4 to 172.4 MPa (8.9 to 25 ksi) for the stone interlayer pavement. These results show the consistent subgrade conditions and uniformity of lime treatment construction in both pavement types. The variation of the average resilient modulus of subgrade soils with traffic loading is presented in Figure 10b. The resilient modulus of subgrade soil on LA-97 is consistent for both pavement types and on average is equal to 103.4 MPa (15 ksi).

TABLE – 2: Nondestructive evaluation of pavement layer during construction.

Test Section	Test Date	Tested Pavement Layer Surface	NDT Evaluation					
			Measured Structural Number (SN)		Resilient Modulus, (M <sub>r</sub> )		SCI, mm×10 <sup>-3</sup> (in.×10 <sup>-3</sup> )	
			Mean	COV (%)	Mean, MPa (psi)	COV (%)	Mean	COV (%)
Conventional Pavement Section #1	Feb-91	Lime-stabilized sub base	–	–	–	–	–	–
	March-91	Soil-cement base	3.3	10	83.88 (12,166)	15	2.0 (0.08)	18
	March-91	HMAC surface	5.3	6	136.74 (19,833)	13	0.8 (0.03)	23
	Aug. -91	HMAC surface	6.7	4	120.66 (17,500)	11	0.8 (0.03)	20
	March-93	HMAC surface	5.9	7	147.37 (21,375)	10	1.0 (0.04)	35
	Feb.-95	HMAC surface	5.4	12	67.17 (9,742)	18	1.0 (0.04)	60
	Sept.-96	HMAC surface	6.2	13	135.02 (19,583)	14	0.5 (0.02)	46
	April-01	HMAC surface	6.2	4	95.00 (13,779)	9	0.8 (0.03)	29
Stone Interlayer Pavement Section #2	Feb-91	Lime-stabilized sub base	0.03	42	75.36 (10,930)	17	16.3 (0.64)	32
	March-91	Soil-cement base	1.8	32	67.68 (9,816)	14	5.1 (0.20)	30
	March-91	Limestone interlayer	3.5	16	69.84 (10,130)	24	2.0 (0.08)	49
	March-91	HMAC surface	4.0	8	120.66 (17,500)	19	2.3 (0.09)	17
	Aug. -91	HMAC surface	6.2	4	124.10 (18,000)	11	1.3 (0.05)	20
	March-93	HMAC surface	5.5	5	144.79 (21,000)	13	1.5 (0.06)	18
	Feb.-95	HMAC surface	4.6	10	75.50 (10,950)	22	1.8 (0.07)	19
	Sept.-96	HMAC surface	6.4	6	128.59 (18,650)	15	1.0 (0.04)	33
April-01	HMAC surface	5.5	7	93.25 (13,525)	14	1.8 (0.07)	24	

SN: Structural Number, M<sub>r</sub>: Resilient Modulus Subgrade Soil, SCI: Surface Curvature Index

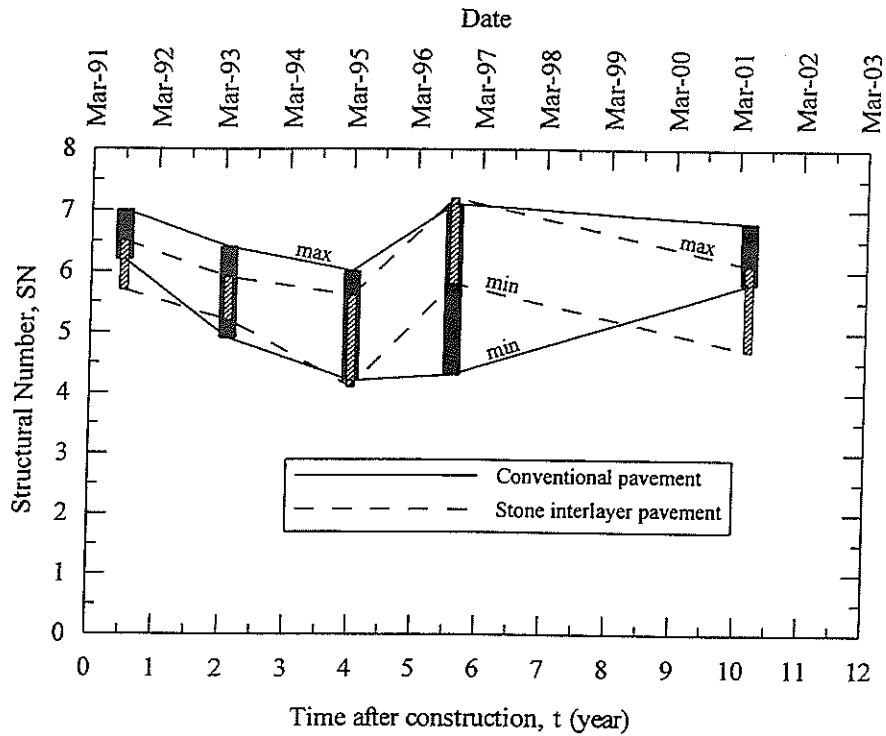

(a) Maximum and minimum SN values for the conventional and stone interlayer pavements.

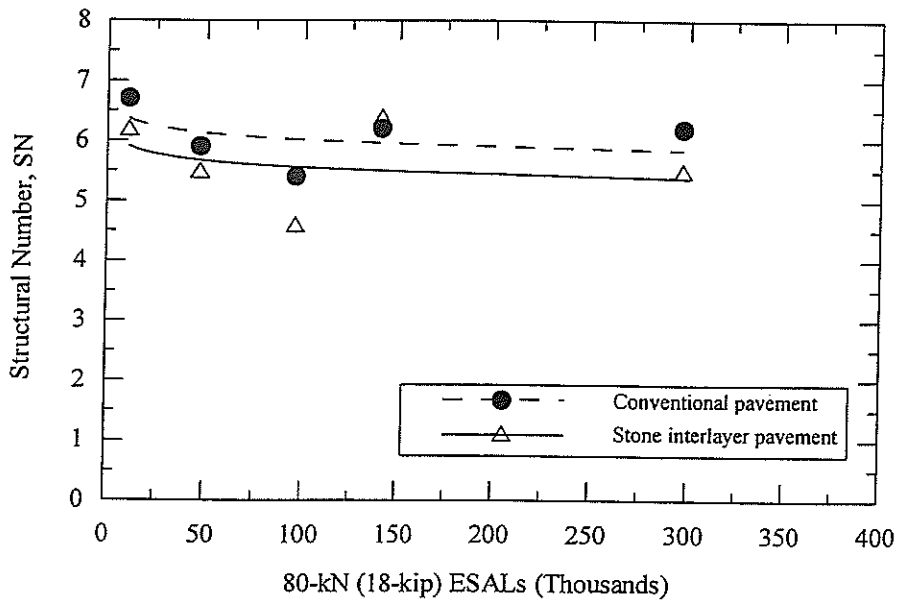

(b) Comparison of average SN for the investigated pavement types

Figure 9: Comparison of structural capacity performance of the conventional and stone interlayer pavements over a 10-year period.

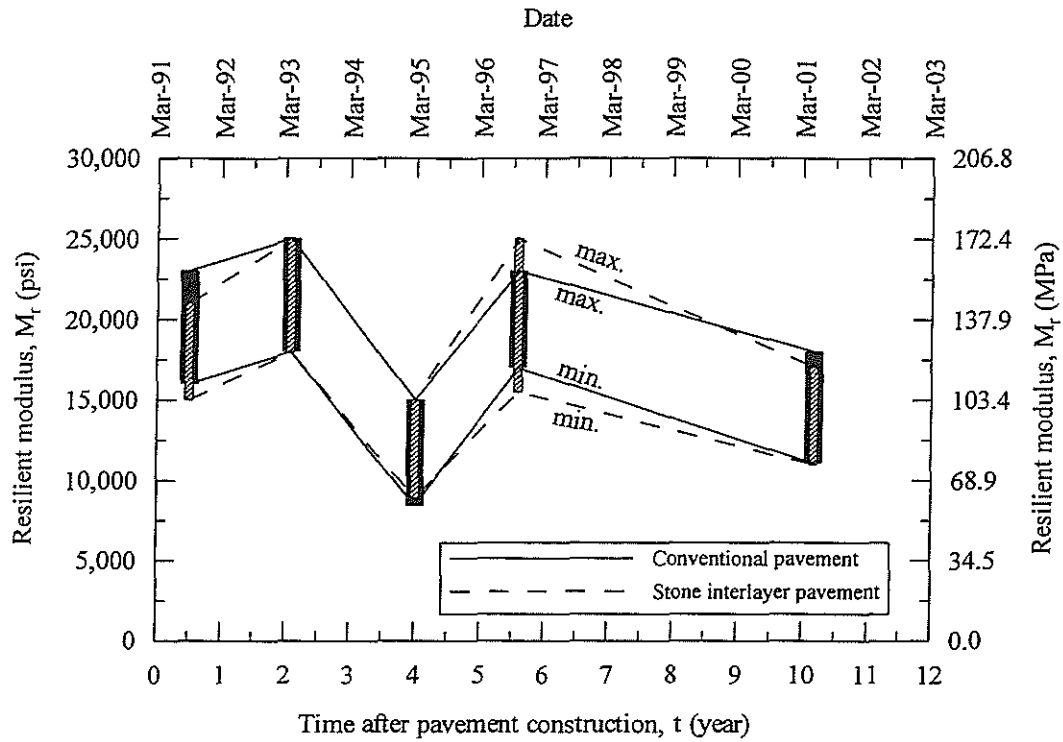

(a) Maximum and minimum resilient modulus values of subgrade soil for investigated pavements.

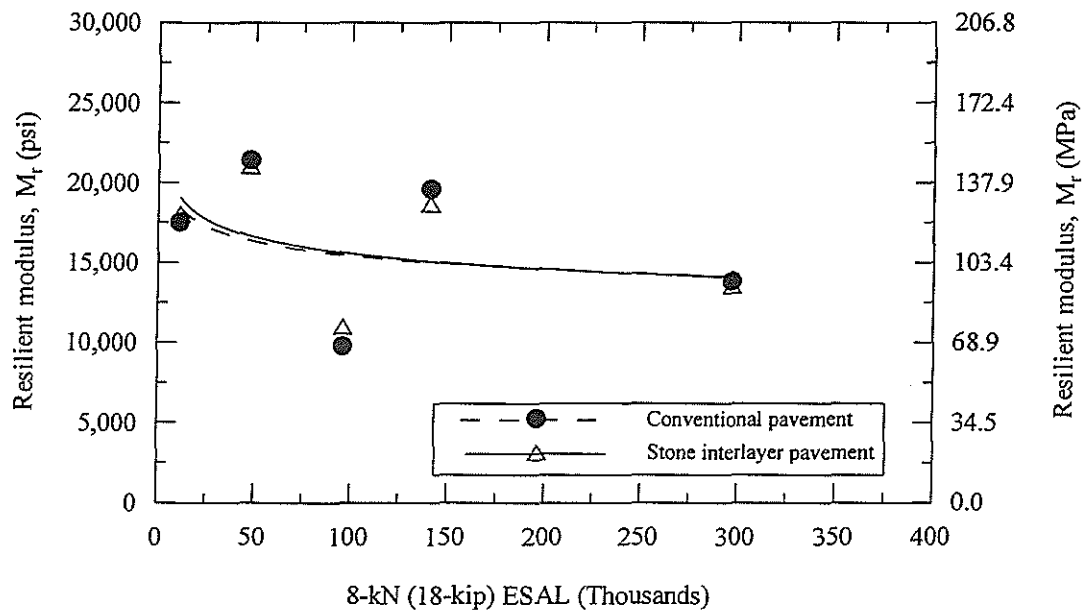

(b) Comparison of average resilient modulus of subgrade soil for investigated pavements.

Figure 10: Comparison of resilient modulus of subgrade soil for the conventional and stone interlayer pavements over a 10-year period.

## **Pavement Roughness and Permanent Deformation**

Figure 11a shows the variation of IRI with time for the conventional and stone interlayer pavements. The average IRI for the stone interlayer pavement is low, indicating a smooth pavement surface and good ride quality. The average IRI 10.2 years after highway construction is 1.03 mm/m (65 in./mile) while the average IRI for the conventional pavement is 1.25 mm/m (79 in./mile), which also is considered within the good ride quality range. The stone interlayer pavement showed consistently better ride quality compared to the conventional pavement. The reason could be related to the amount of reflective cracking developed within the conventional pavement.

The Present Serviceability Index for the investigated pavement types is shown in Figure 11b. PSI values for the conventional and stone interlayer pavement have slightly decreased since pavement construction. However, the PSI values are higher than 4.0, which put both pavement types after 10.2 years of service in the very good category.

Measurements of permanent deformation showed that the mean rut depth for the conventional pavement is 3.3 mm (0.13 in.) and for the stone interlayer pavement is 3.8 mm (0.15 in.). These results are consistent with typical consolidation under traffic, and indicate that neither type of base design suffered pavement rutting.

## **Pavement Performance under Accelerated Loading**

In order to verify the field performance of the alternative stone interlayer pavement design, one lane of the nine test lanes (denoted as lane S-009) studied under the first Louisiana accelerated pavement testing experiment at the Pavement Research Facility was constructed with a stone interlayer base course. The purpose of this experiment was to evaluate alternative base courses with potential for reduced reflective cracking but no loss of structural capacity. To achieve this objective, nine full sized test lanes were constructed in 1995 and were subsequently tested to failure under accelerated loading.

The two test lanes constructed at PRF site to verify the behavior of stone interlayer pavement are test lanes S-008 and S-009. The test lanes were tested under accelerated loading using the ALF machine. The test lane S-008 is a conventional pavement type with 216 mm (8.5 in.) of in-placed stabilized soil cement with 10 percent cement content and 89 mm (3.5 in.) of standard Type 8 HMA surface layer. The test lane S-009 is a stone interlayer pavement which consisted of 89 mm (3.5 in.) of standard Type 8 HMA surface layer, 102 mm (4 in.) of crushed stone constructed over 152 mm (6.0 in.) of in-placed stabilized soil cement with 10 percent cement content.

The test lanes' performance was determined by the amount of simulated traffic loading in ESALs received at failure. The primary failure criteria were rutting of 25.4 mm (1.0 in.) and a cracking density of 4.92 m/m<sup>2</sup> (1.5 ft/ft<sup>2</sup>) in 50 percent of the tested area. The accelerated pavement testing results (Table 3) indicated that the stone interlayer pavement lane received 4.7 times the ESALs of the conventional pavement lane before failure. The stone interlayer pavement also outperformed all eight other lanes tested

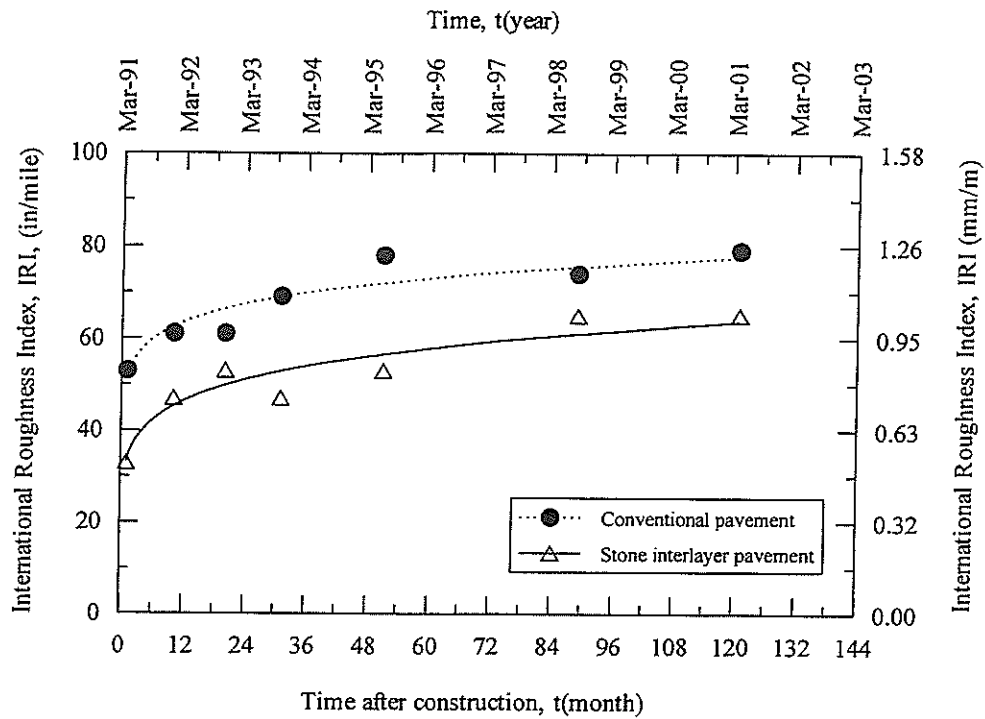

(a) Comparison of the conventional and stone interlayer pavement roughness over a 10-year period

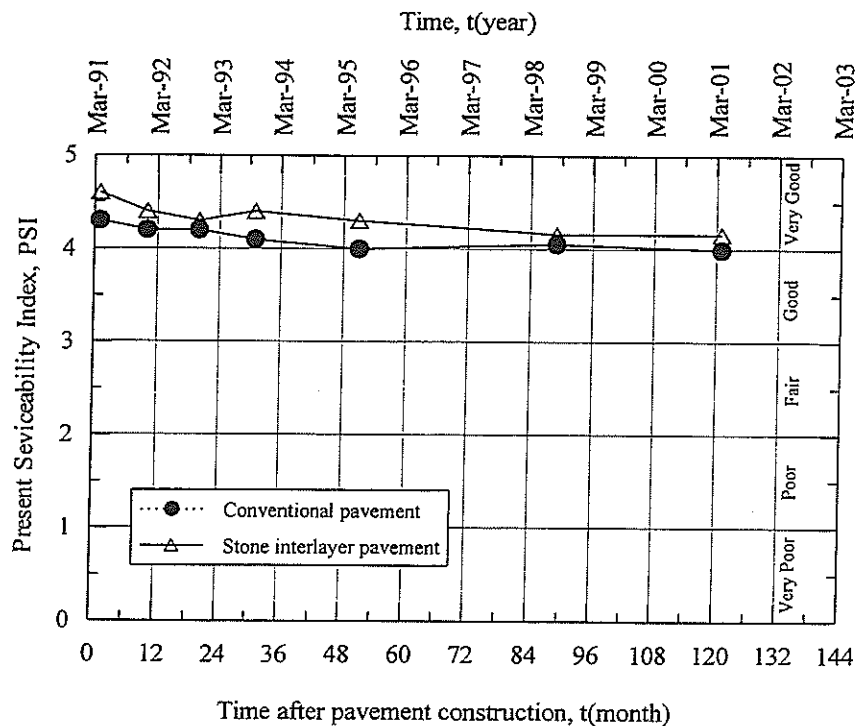

(b) Evaluation of Pavement Serviceability Index for the conventional and stone interlayer pavement roughness over a 10-year period

Figure 11: Comparison of ride quality of the conventional and stone interlayer pavements over 1 10-year period



Table 3 – Results of accelerated loading tests on the conventional and the stone interlayer pavement.

Test Lane	Pavement Type	Cement Content (%)	ESALs Total
S-008	Conventional	10	314,500
S-009	Stone Interlayer	10	1,294,800

under the first Louisiana accelerated pavement-testing experiment. The accelerated pavement testing results clearly verify the superior performance of the stone interlayer pavement design concept. This is particularly true where there is high moisture content in the base, which was the case for this experiment.

## COST ANALYSIS

A cost/benefit analysis was conducted to show the benefits of constructing an alternative stone interlayer pavement over the conventional soil-cement pavement. A typical 8-m (26-ft) wide, two-lane flexible pavement with conventional soil-cement pavement design (Figure 4b) will cost about \$107,500/km (\$173,000 per mile) for materials only. The cost of the alternative stone interlayer pavement (Figure 4c) will cost about \$129,300/km (\$208,000 per mile). Although the initial cost of the alternative stone interlayer pavement design is 20 percent higher than that of the conventional soil-cement pavement design, its load carrying capacity is increased by a factor of 4.7, as shown in the accelerated pavement testing, and by a factor of 1.5 as, shown from the analysis of long-term performance data.

It should be noted that the alternative stone interlayer pavement is rated higher for traffic capacity compared to the conventional soil-cement pavement. For low volume roads, the flexible pavement asphalt layer can be further reduced to 51 mm (2.0 in.) over the stone interlayer base course. A typical 8-m (26-ft) wide, two-lane highway comprising a 51 mm (2-in.) HMAC surface with a 102 mm (4-in.) crushed limestone over a 152 mm (6-in.) soil cement base can be built for about \$96,300/km (\$155,000 per mile). This type of stone interlayer pavement design is about 10 percent less expensive than the conventional soil cement pavement design and has longer lasting potential.

To further reduce the cost of the stone interlayer pavement, LTRC is currently evaluating the effectiveness of Reclaimed Asphalt Pavements (RAP) in lieu of the crushed limestone. This is being conducted under accelerated loading conditions through the third ALF project. A section of the U.S. highway 190 was also constructed using RAP interlayer design. These projects are expected to determine the reliability of using less expensive materials while achieving similar performance, as indicated in this report for the inverted pavement systems.

## CONCLUSIONS

The stone interlayer pavement design experienced less cracking density compared to the conventional design after ten years of service. The majority of the cracks within the stone interlayer pavement were of low severity level (hairline cracks), while almost half of the cracks within the conventional pavement were medium severity with some at high severity level. Both pavement types showed low levels of permanent deformation with mean rut depth less than 4 mm.

The initial investment increase of 20 percent for an inverted pavement is due to the cost of the crushed stone layer. However, for smaller traffic volume, an inverted pavement design with thinner asphalt will be more economical and provide a longer service life than a soil cement pavement design.

The stone interlayer pavement showed similar structural capacity compared to the conventional soil-cement pavement for the evaluation period. The stone interlayer pavement also showed consistently better ride quality compared to the conventional soil-cement pavement for the evaluation period.

The stone interlayer pavement design outperformed the soil cement pavement design under accelerated pavement testing.

## RECOMMENDATIONS

Based on the overall performance of the stone interlayer pavement design, we recommend constructing this type of pavement to reduce reflective and total cracking and to increase the life of the pavements with soil-cement base.

We strongly recommend that the Louisiana Department of Transportation and Development adopt this stone interlayer design alternative to produce more durable and longer lasting highways.

## REFERENCES

Distress Identification Manual for the Long-Term Pavement Performance Project, SHRP-P-338, Strategic Highway Research Program, National Research Council, Washington, D.C., 1993.

AASHTO Guide for Design of Pavement Structures, American Association of State Highway and Transportation Officials, Washington, D.C., 1993.

Metcalf, J. M., Romanoschi, S., Yongqi, Li, and Rasoulian, M., Construction and Comparison of Louisiana's Conventional and Alternative Base Courses Under Accelerated Loading (Interim Report 1, Phase 1), Louisiana Transportation Research Center, Baton Rouge, Louisiana, August 1998.

Kinchen, R.W., and Temple, W.H., Asphaltic Concrete Overlays of Rigid and Flexible Pavements, Final Report, no. FHWA/LA-80/147, Louisiana Department of Transportation and Development, Baton Rouge, LA, 1980

Sayers, M., Gillespie, T.D., and Queiroz, C.A.V. The International Road Roughness Experiment, Establishing Correlation and a Calibration Standard for Measurements, Technical Paper 45, World Bank, Washington D.C., 1986

Rasoulian, M., Becnel, B., and Keel, G., Stone Interlayer Pavement Design, Journal of the Transportation Research Board, TRR No. 1709, National Research Council, Washington, D.C., 2000.