

Louisiana Highway Research

ULTRASONIC WELD TESTING

ULTRASONIC WELD TESTING

by

PHILIP J. ARENA, JR.
BITUMINOUS RESEARCH ENGINEER

J. T. ASHBY, JR.
BITUMINOUS RESEARCH GEOLOGIST

AND

CHARLES HEMPHILL, JR.
STRUCTURAL FABRICATING INSPECTOR

Research Report No. 52

Research Project No. 68-3St
Louisiana HPR 1 (8)

Conducted by
LOUISIANA DEPARTMENT OF HIGHWAYS
Research and Development Section
In Cooperation with
U. S. Department of Transportation
FEDERAL HIGHWAY ADMINISTRATION

"The opinions, findings, and conclusions expressed in
this publication are those of the authors and not
necessarily those of the Federal Highway Administration."

December 1970

TABLE OF CONTENTS

LIST OF FIGURES -----	v
LIST OF TABLES -----	vii
SYNOPSIS -----	ix
INTRODUCTION -----	1
SCOPE -----	1
METHODOLOGY -----	2
General -----	2
Laboratory Study -----	2
Field Study -----	3
BASIC THEORY -----	4
DISCUSSION OF RESULTS -----	7
General -----	7
Laboratory Study -----	10
Field Study -----	14
CONCLUSIONS -----	15
RECOMMENDATIONS -----	17
BIBLIOGRAPHY -----	19
APPENDIX 1 - AWS SPECIFICATIONS FOR ULTRASONIC TESTING OF GROOVE WELDS -----	23
APPENDIX 2 - GLOSSARY OF ULTRASONIC TERMS -----	43
APPENDIX 3 - COMPARISON OF ULTRASONIC RESULTS TO THAT OF RADIOGRAPHY BY MACHINING -----	55

LIST OF FIGURES

Figure No.	Title	Page No.
1	Butt Weld Inspection with Two Transducers -----	5
2	Sound Path Distance Resolved into Depth and Horizontal Distance -----	5
3	Search Unit Travel is a Measure of Defect Length -----	6
4	Travel to and from Weld Reveals Defect Height -----	6
5	Pulse Shape Indicates Nature of Defect -----	6
6	Ultrasonic Test Report -----	8
7	Defect Location Chart -----	9
8	Special Measuring Tape -----	9
9	Spherical Slag Inclusion -----	11
10	Slag Inclusion with Crack -----	12
11	Node and Change in Node -----	12
12	Large Slag Inclusion -----	13
13	Slag Line -----	13
14	Lack of Penetration -----	13
15	Porosity -----	13
16	Lack of Fusion -----	13
17	Slag with Crack -----	13

LIST OF TABLES

Table No.	Title	Page No.
1	Comparison of Sensitivity of Ultrasonic Testing and Radiography -----	7
2	Sound Path Table for 60° Wedge-Steel -----	9
3	Comparison of Defect Length and Depth as Determined by Ultrasonic Testing to Actual Defect Length and Depth as Determined by Machining -----	55

SYNOPSIS

Ultrasound and its application as a tool in non-destructive testing has experienced considerable growth in the past few years. This study was initiated to determine if ultrasonic testing could replace the use of radiography in the inspection of full penetration butt welds of steel or merely supplement radiographic inspection. Another phase of this research was to ascertain the best method of incorporating ultrasonic testing into our present testing program should ultrasonic testing prove to be superior to radiography.

The study was broken down into two phases. Phase I consisted of a laboratory investigation of test specimens to determine the reliability of the ultrasonic equipment and testing procedure. Phase II was a field study where the knowledge, skills and abilities gained in the laboratory study were applied to actual fabrication being done for the Louisiana Department of Highways. The testing for both phases of the study was performed in accordance with the American Welding Society Specifications of Welded Highway and Railway Bridges, Ultrasonic Testing of Groove Welds.

A comparison of ultrasonic testing to radiographic testing reveals many advantages of ultrasonic testing. Some of these advantages are:

1. Unlike radiography, ultrasonics is more sensitive to the more severe defects.
2. Ultrasonics provides immediate test results.
3. Rejection is based solely on defect amplitude and/or length.
4. Cost of ultrasonic equipment is minimal when compared to radiographic equipment.

The testing procedure for ultrasonics is a tedious task with a high risk of human error. It is therefore the conclusion of the researchers that ultrasonic testing, as it now exists, cannot replace radiography, but it could be used to supplement radiography to locate defects such as cracks or lack of fusion that may not be detected with radiographic inspection.

If the improvements and refinements in both the testing equipment and testing procedure continue at the same rate they have in the past few years, the fabricators will adopt the use of ultrasonic testing over the more expensive and time consuming radiographic inspection.

Therefore, it is the recommendations of the investigators that the Louisiana Department of Highways prepare themselves to be capable of qualification of

ultrasonic inspectors. In order to meet this task, the investigators further recommend the following:

1. An individual should be selected and trained thoroughly in ultrasonic theory **and** application. This individual will be the Department's authority on ultrasonics.
2. The trained individual or "authority" should work in liaison with the Louisiana Department of Highways, Training Unit to develop a training program in basic ultrasonics for those individuals selected to qualify ultrasonic inspectors.

INTRODUCTION

The use of ultrasonics as a quality evaluation tool in non-destructive testing has experienced considerable growth in the last few years. Although ultrasonics has a wide and varied field of use and application, this study was limited to its application in the evaluation of full penetration butt welds in steel. This research was initiated to answer three questions: (1) How reliable is ultrasonics in flaw detection? (2) Can ultrasonics replace the use of radiography or merely supplement radiographs? (3) If ultrasonic testing can be incorporated into our testing program, how can it be implemented?

SCOPE

This research was broken down into two phases. Phase One consisted of a laboratory investigation of laboratory fabricated specimens. Phase Two was a field study where the experience gained in the laboratory was applied to fabrication plants performing work for Louisiana.

METHODOLOGY

General

Both in the laboratory and field investigation of butt welds, the ultrasonic equipment, calibration of the equipment, testing procedure and preparation of reports of ultrasonic testing were done in accordance with The American Welding Society Specifications of Welded Highway and Railway Bridges, Ultrasonic Testing of Groove Welds. A copy of these specifications is located in Appendix No. 1.

Laboratory Study

For the initial phase of the laboratory study, 32 laboratory specimens, ranging in thickness from 3/8 inch to 1 1/2 inches, were manually butt welded by the shielded metal-arc process. The welding procedure was varied in an attempt to create defects within the weld. After welding, the weld crowns were removed and the specimens were radiographed. The defects located by the radiographs were defined and recorded.

The laboratory specimens were then inspected by ultrasonics, as described by the AWS specifications, using the radiographs as an aid in locating the defects. The defects located by ultrasonics were recorded as to location from the axis of the weld, the edge of weld, depth from the surface and length. In addition to location of the defects, the defect was rated as to its severity and an attempt was made to type the defect, i. e., was the defect a slag inclusion, porosity, lack of fusion, lack of penetration, crack, etc.

After the ultrasonic inspection was completed, the test plates were then machined and the defects located and recorded as to length, depth and type.

A second set of 30 laboratory specimens was prepared in the same manner as the first set. However, the second set was not radiographed until the ultrasonic inspection was completed. The plates were machined and the defects located.

After the machining of the plates was completed, the radiographic, ultrasonic and machining reports were compared as to location, length, depth and type of defect to ascertain whether the ultrasonic testing could locate the defect and give the length and type of defect as well as radiography. The depth of the defect, as located by ultrasonics, could only be checked by machining.

Field Study

The knowledge, skills and abilities gained from the laboratory study were next applied to actual construction in steel fabrication plants. The main function of the field study was to ascertain if ultrasonic inspection could be applied to actual construction in a reasonable and practical manner.

At the time of the field investigation there were three fabricators doing work for the Louisiana Department of Highways: two in Houston, Texas, and one in New Orleans, Louisiana. It should be noted that the ultrasonic testing was conducted on transition butt welds that had been recently radiographed or were soon to be radiographed, and at no time was the ultrasonic testing used as the only means of quality testing.

BASIC THEORY

For this report, no attempt will be made to describe the complete nature of ultrasonics. There are numerous excellent texts available on the subject, a few of which are listed in the Bibliography.

Perhaps the best analogy that can be used to explain ultrasound and its behavior within a medium into which the ultrasound is induced, is to compare the beam of ultrasound to a narrow beam of light introduced into a room with the walls, floor and ceiling composed of mirrors. As the beam of light travels through the room, it will be reflected off of the walls, floor or ceiling, depending upon where and at what angle the light beam is induced.

If several small mirrors were suspended within this room, it would be possible to reflect this beam of light off of these suspended mirrors if the angle and point of entry of the beam were controlled. By knowing the point of entry and at what angle the light entered the room, the suspended mirrors can be located by measuring the time it takes the beam to reach the individual mirrors, i. e., $\text{distance} = \text{velocity} \times \text{time}$.

This is the basic theory of ultrasonics. The mirrored walls, floor and ceiling represent the boundaries of the medium into which the ultrasound is induced, and the suspended mirrors represent defects or flaws within the medium.

The ultrasound, unlike the beam of light, is not a steady signal but a series of sound pulses generated by a piezoelectric transducer*. The transducer takes an electrical impulse and transforms it into mechanical energy which is sent into the medium, in this case, steel. This pulse travels in a straight line until it is reflected by a boundary surface or a defect within the steel. The transducer then receives this reflected energy and transforms this reflection back into electrical energy which in turn is displayed on a cathode ray tube. There are two methods by which a transducer can receive the reflected pulse. One, which could be called "toss and catch", requires the use of two transducers. One transducer sends or "tosses" the pulse and the other transducer receives or "catches" the pulse. Figure 1 illustrates this method.

* A glossary of ultrasonic terms is listed in Appendix 2.

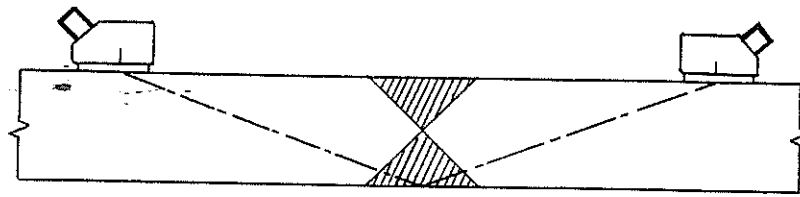

Figure 1

Butt Weld Inspection with Two Transducers

The second method by which a transducer sends and receives a signal is the "pulse-echo" method. This requires the use of a single transducer. The transducer emits a pulse and then waits or "listens" for the return echoes. The rate at which these pulses are sent out usually range from 50 to 2,000 times per second. This is the method of testing used throughout this study.

The testing, as used in this study, made use of two methods of introducing the ultrasound into the test specimens: straight beam and angle beam testing. Straight beam testing, as the name implies, consists of the transducer or search unit inducing the ultrasound in a direction perpendicular to the test surface. This form of testing is often referred to as longitudinal wave testing due to the fact that longitudinal waves are the predominant wave form. Angle beam testing is a technique in which the transducer induces the ultrasound at an angle to the test surface. This form of testing is often referred to as shear wave testing due to the nature of the wave form produced by this testing technique.

The equipment used for this study was of such a nature that the sound path distance could be read directly from the CRT. Once the sound path distance is established for a defect, the defect can be easily located. For straight beam testing, the defect location is the depth read directly from the CRT. In angle testing, the defect is located by resolving the sound path distance into its vertical and horizontal components. The vertical component represents the depth of the defect and the horizontal component the horizontal distance from the point of entry of the sound. Figure 2 represents a defect sound path for a 70° wedge transducer resolved into its vertical and horizontal components.

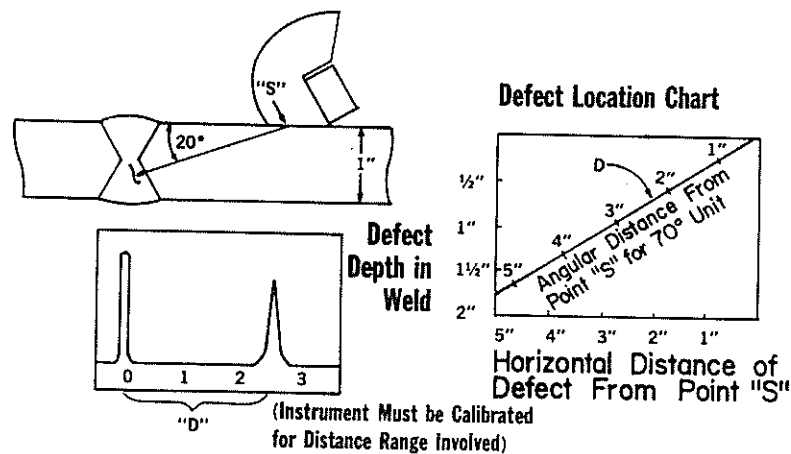

Figure 2

Sound Path Distance Resolved into Depth and Horizontal Distance

Not only can the depth of the defect be determined by ultrasonic testing, but defect length, height and type can be ascertained. The length can be determined by the measured travel of the transducer along the length of the defect. Height of the defect is measured by travel to and from the defect. Defect type can be ascertained by the pulse shape displayed on the CRT. Figures 3 to 5 illustrates these principles.

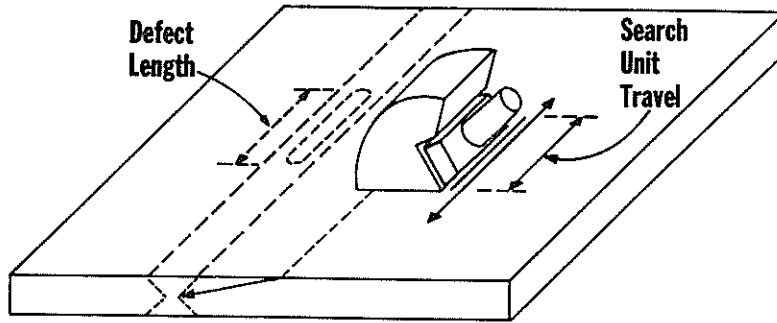

Figure 3
Search Unit Travel is a Measure of Length

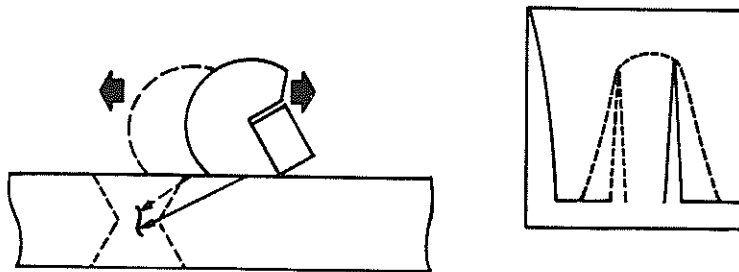

Figure 4
Travel to and from the Weld reveals Defect Height

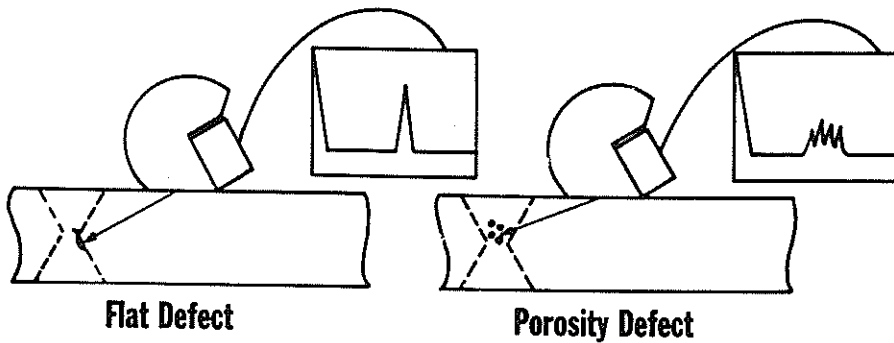

Figure 5
Pulse Shape indicates Nature of Defect

DISCUSSION OF RESULTS

General

The most common non-destructive form of testing butt welds is radiography. Simply stated, a radiograph of a butt weld consists of a sheet of photographic film placed on one side of the weld and bombarded by radioactive particles from the other side. Defects within the weld allow the radioactive particles to penetrate more easily and appear as dark spots upon the film. Therefore, it is obvious that the smaller the area the defect presents the less likely it is to be shown on the radiograph. Unfortunately, the most serious defects are the most poorly detected by radiography, i.e., cracks, lack of fusion and lack of penetration.

The reverse is true for ultrasonic testing. The nature of ultrasonic testing makes it more sensitive to the more severe type defects. The relationship between defect severity and detection by ultrasonics and radiography is shown in Table 1.

TABLE 1

COMPARISON OF SENSITIVITY OF ULTRASONIC TESTING AND
RADIOGRAPHIC TESTING

	<u>Defect Concern</u>	<u>Ultrasonic Sensitivity</u>	<u>Radiographic Sensitivity</u>
Cracks	↑	↑	↓
Incomplete Fusion	↑	↑	↓
Inadequate Penetration	↑	↑	↓
Slag	↑	↑	↓
Porosity	↑	↑	↓

Radiography requires accurate defect identification to detect the more serious defects. Ultrasonic testing defines defects solely on severity (signal return) and length, thus eliminating the necessity of defect definition.

Radiography provides direct physical documentation of the tested weld. At this time, ultrasonic testing can not provide this documentation. In an effort to provide a record of testing, a report form was developed as shown in Figure 6. This form, with the necessary information, will provide the documentation necessary. For example, in Figure 6 one rejectable defect was located in this weld. This defect was 0.6 inches long and it was located on the centerline of the weld 3 1/2 inches from the left or "y" end of the weld.

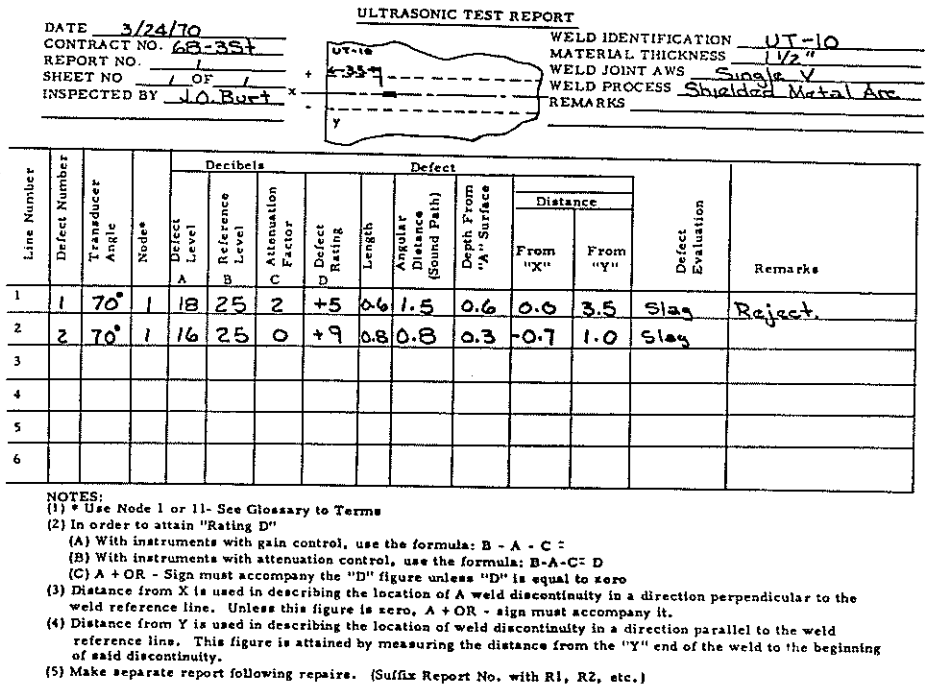

Figure 6

Ultrasonic Test Report

As explained in the section of Basic Theory, defect location with ultrasonics is based on the sound path. A defect in the weld is initially located in relation to the transducer by resolving the sound path distance into its vertical and horizontal components. The vertical component represents the depth of the defect from the surface, and the horizontal component the location in front from the point of entry of the sound.

There are many methods of resolving the sound path into its components. The two most common methods are the use of defect location charts or special measuring tapes. Figures 7 and 8 show these methods.

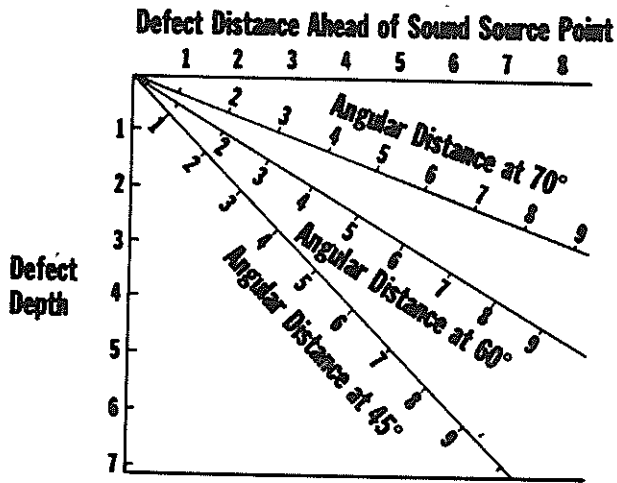

Figure 7
Defect Location Chart

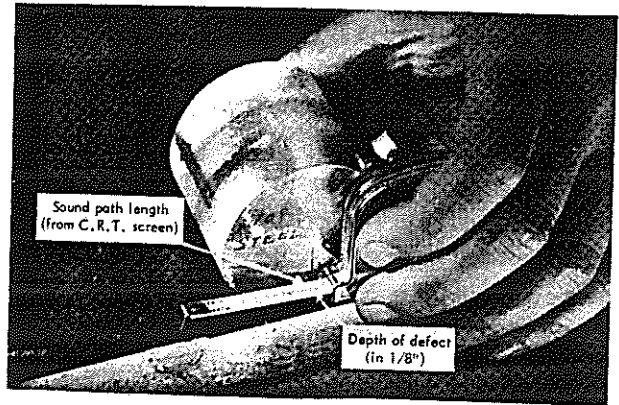

Figure 8
Special Measuring Tape

However, it was the opinion of the investigators that the defect location charts did not provide the accuracy desired for this study, and that the tapes were too awkward. In an attempt to provide a rapid and accurate method of determining the components of the sound path, a sound path table was computed for each angle wedge used in this study. Table 2 shows a portion of the sound path table for the 60° wedge. The first number represents the sound path in 0.1 of an inch; the second and third numbers are the horizontal and vertical components respectively.

TABLE 2
SOUND PATH TABLE FOR 60° WEDGE-STEEL

Sound Path Distance (inches)	Horizontal Component	Vertical (Depth) Component
2.0	1.73206	1.00000
2.1	1.81866	1.05000
2.2	1.90526	1.10000

Once the defect is located in reference to the transducer, it is a simple matter of measurement to relocate the defect in reference to the "x" axis (center line of the weld) and the "y" axis (the edge of the weld).

In order for the search unit to transmit the ultrasound into the test specimen in the most effective manner, a coupling medium is needed. The coupling medium or couplant needs to be of a lubricating nature so that the search unit can be maneuvered in an easy manner. The couplant should be capable of efficient sound transmission to minimize sound loss and to compensate for surface roughness. Based on evaluations of other researchers, glycerine was selected for use as a couplant. Glycerine has acoustical properties closely approximating that of the lucite wedge of the search unit, thus minimizing fraudulent signals due to surface roughness.

Laboratory Study

As stated before, all ultrasonic testing was performed according to the American Welding Society specifications. Due to the thicknesses of the welded plates used in this study, the specifications required that all angular or shear wave inspection be performed with the 70° lucite wedge and a 2.0 to 2.5 MHz transducer. Glycerine was selected as the couplant since its transmissivity is very similar to that of lucite.

Initially, 32 laboratory plates were manually butt welded by the shielded metal arc process and the weld crowns removed by hand grinding. These plates were then radiographed.

Using the radiographs as guides, the plates were tested with the ultrasonic equipment to ascertain if the equipment could locate the defects visible on the radiographs.

In many instances the test specimens contained numerous defects, and it was decided that in these cases only two or three of the more sizeable defects would be evaluated.

A second set of 30 test specimens were welded in the same manner. However, these plates were inspected with ultrasonics prior to being radiographed. The main purpose of this phase of the study was to determine if the ultrasonic equipment could locate all the defects that would be shown in the radiographs and possibly locate defects not shown in the radiographs.

Once the test specimens had been tested by both radiography and ultrasonics, the test specimens were machined to determine the true location of the defects described. The results of the machining were generally quite good. Depth

location was the most accurate of the physical properties measured by ultrasonics. The defect depth location was accurate to ± 0.05 of an inch. Defect length determination varied in accuracy. Defects that were tabular in shape such as slag inclusions, lack of penetration, straight cracks, etc., correlated closely to actual defect length (± 0.1 of an inch). However, when the geometry of the defect varied from the tabular and approached a more spherical shape, the defect lengths became more erroneous. An extreme example of this effect is test specimen UT-27. The defect length as determined by ultrasonic testing was 0.8 inch. However, when the plate was machined, the actual defect length was 0.15 inch. Figure 9 illustrates this defect. Note the spherical shape of this slag inclusion.

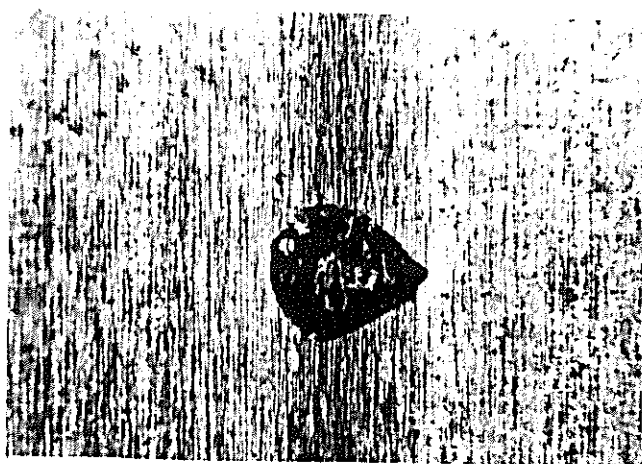

Figure 9

Spherical Slag Inclusion

Another instance of the shape of the defect giving an erroneous defect length is test plate UT-50 (see Figure 10). In this instance, the measured UT defect length was 0.7 and the actual length was 0.2. This erroneous measurement can be attributed to two features of this defect: one, the spherical shape of the main body of the defect and two, the jagged, tail-like crack at the end of the defect provides an uneven reflecting surface.

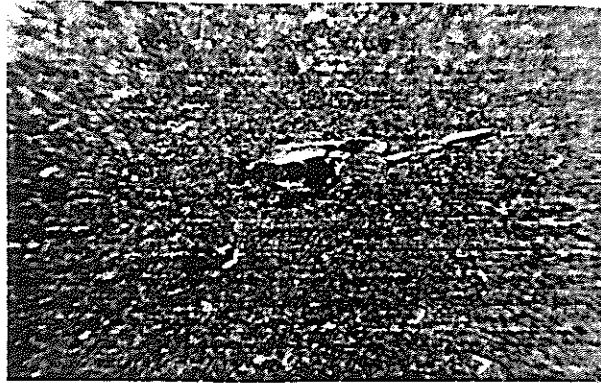

Figure 10
Slag Inclusion with Crack

The results of the comparison of ultrasonic measurements to that of defect length and depth from machining for each test specimen is presented in Table 3 of the Appendix No. 3.

A final note on spurious defect lengths; change in node. Node is the distance the shear wave travels before being reflected by the back surface of the material being tested. Figure 11 illustrates node and change in node.

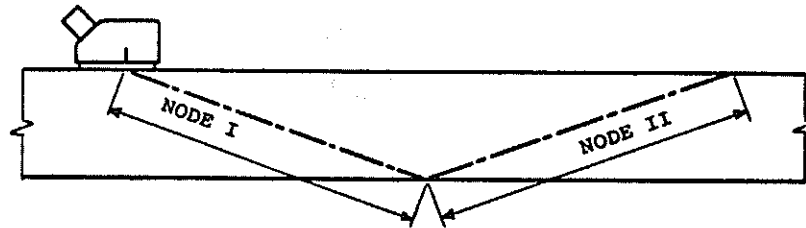

Figure 11
Node and Change in Node

Change in node or "bouncing" of the ultrasonic beam results in errors in defect length and location due to spreading of the beam.

Figures 12 through 17 are a representative cross-section of the type of defects dealt with in the laboratory study.

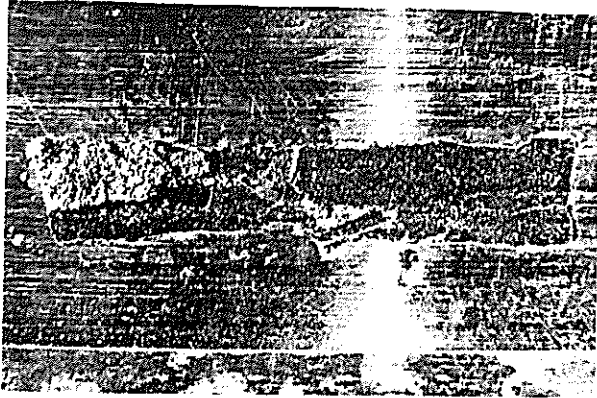

Figure 12
Large Slag Inclusion

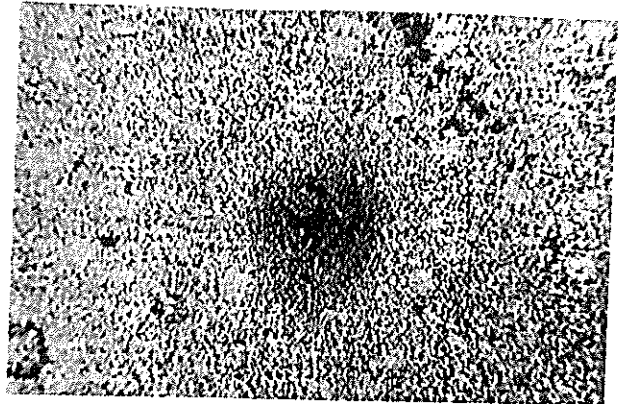

Figure 15
Porosity

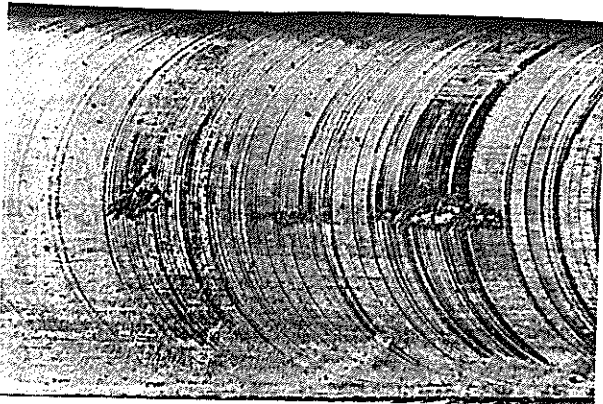

Figure 13
Slag Line

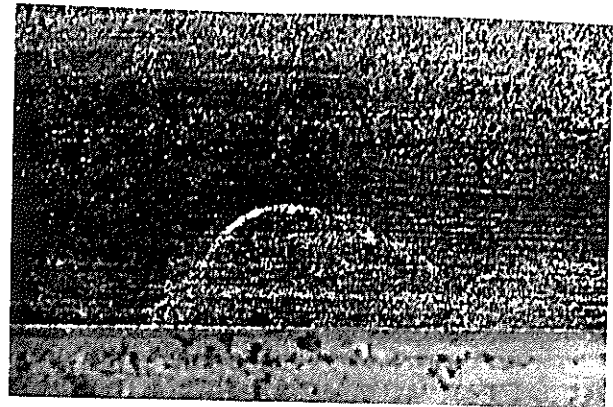

Figure 16
Incomplete Fusion

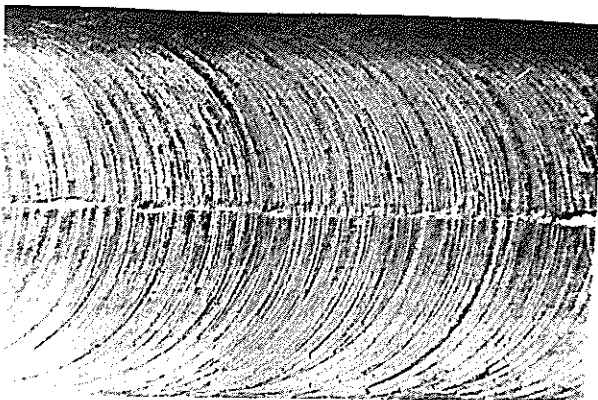

Figure 14
Lack of Penetration

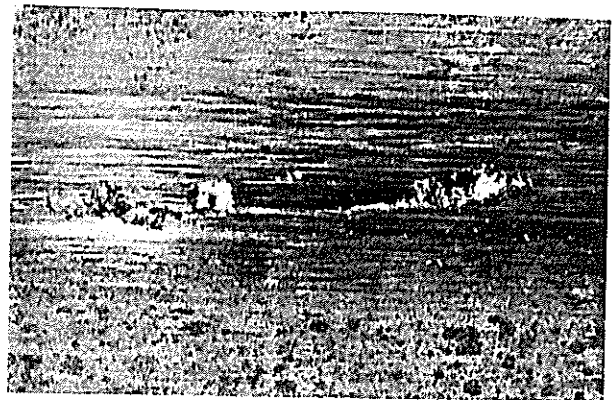

Figure 17
Slag with Crack

Field Study

After completion of the laboratory study, the experience gained in the use of ultrasonic testing was applied to actual steel fabrication.

It was not the purpose of the field study to ascertain if the ultrasonic testing method could locate defects within welds, but rather to determine if ultrasonic testing could be easily and practically applied as a non-destructive test method in shop production*.

At the time of the field study, there were three fabricators working on projects for the State of Louisiana: one in New Orleans, Louisiana and two in Houston, Texas. The first shop visited was in New Orleans where the ultrasonic testing was performed on several transition butt welds.

In all cases, these welds had been or were soon to be radiographed, and the ultrasonics was applied only as a supplementary method of testing.

The transition welds presented a different make-up in geometry not experienced in the laboratory study. However, this did not present too difficult a problem, and the testing proceeded as planned. The correlation between the ultrasonic testing and radiograph was good.

At the two fabricating plants in Houston, Texas not only were transition welds tested, but two bearing plates were tested with the longitudinal transducer for known laminations. Again, the results were quite good when compared to radiographs and prior testing.

* As in the laboratory study, all ultrasonic testing executed in the field was performed according to the procedure and methods as set forth in the AWS specifications (see Appendix).

CONCLUSIONS

The first question that this research sought to answer was: Can ultrasonic testing locate and define defects within butt welds? The answer is yes.

The second question this study aspired to answer was: Can ultrasonic testing replace radiography or merely be used to supplement radiography? The answer is yes and no. In theory, ultrasonic testing is far superior to radiography for 6 basic reasons.

- (1) The nature of ultrasonics makes it most sensitive to those more severe defects that radiography is most likely not to show, such as cracks, laminations and lack of fusion.
- (2) Ultrasonic testing provides immediate test results. There is no "down-time" waiting for film to be developed and viewed.
- (3) Since rejection of a weld for defects is based solely on defect amplitude and/or defect length, it is not necessary for defect interpretation, as is the case with radiography.
- (4) Ultrasonic testing can be conducted as each individual weld is completed. It is not necessary to complete numerous welds before testing, as is the practice for radiography.
- (5) Ultrasonic testing can be conducted in the immediate vicinity of other welding, without hazard to either the operator of the equipment or other welders. In other words, it is not necessary to close off a large area of the shop for testing, as required for radiography.
- (6) The cost of ultrasonic testing equipment is minimal when compared to the cost of radiographic equipment or the cost of radiographs when the testing is conducted by independent testing laboratories.

As stated before, in theory ultrasonics could replace radiographic testing. However, like many things, theory and practical application of the theory vary considerably.

In any form of material testing, when the risk of human error can be minimized or eliminated, the more valid and repeatable the test becomes. It is this risk of human error that is the basic deficiency of ultrasonic testing of butt welds

If there was to be a number one axiom for ultrasonic testing, it would be: "The results of ultrasonic testing are no better than the personnel operating the equipment."

At best, the testing procedure for ultrasonics is a tedious and time consuming task. However, as tedious as this procedure may be, it is a necessary one if 100% of the weld is to be tested.

It is one thing to test easily manipulated test specimens in an air-conditioned laboratory, but an entirely different and difficult matter in the fabrication shop. The heat and noise encountered in the shop is not conducive to the concentration required to perform a thorough and conscientious test. In addition to the heat and noise, the physical location of the welded material is generally located in such a manner as to require the operator to crouch or kneel to perform the testing. Over a period of just a few minutes, this position creates extreme discomfort to the operator.

It is therefore the conclusion of the investigators that although the ultrasonic equipment and testing procedure is more than capable of locating all the defects within the butt welds, the time and concentration required to perform the testing and the conditions under which the testing is accomplished allow too great a risk of human error to consider replacing radiography with ultrasonic testing.

However, ultrasonic testing provides information that is not readily obtainable with radiographic inspection, and the use of ultrasonics should not be totally discounted as a non-destructive testing tool. At the present, it is the conclusion of the investigators that ultrasonic testing be used to supplement radiographic inspection of critical welds only.

RECOMMENDATIONS

The theory and the application of the theory of ultrasonic testing has advanced rapidly over the last few years and will continue to do so. As stated before the testing procedure for butt welds as it now exists is a tedious task that is conducive to physical and mental fatigue; the resultant of which is a high risk of human error.

However, if the improvement and refinement of the ultrasonic equipment continues at the same rate as it has in the past few years, the testing equipment will become more automated and simpler to operate. As these improvements occur the training and the experience required to perform competent ultrasonic testing will become more minimal. The end result of all these improvements will be the broad acceptance of ultrasonic testing, in lieu of the more costly radiographic testing, by the structural fabricators.

An example of these improvements to come is illustrated by a recent study completed under the supervision of the U.S. Department of Transportation, Federal Highway Administration, titled, "Nondestructive Field Testing of Welds", (NDH Item No. 3, August 1970). The abstract of which reads:

"A recent study reports the development of ultrasonic weld inspection devices and portable radiographic equipment which in combination can reduce the cost of radiographic inspection to one-tenth of that now required. Essential to this cost saving is the ultrasonic preliminary screening of good welds from questionable ones to eliminate most of the costly radiography currently required. The self-contained field X-ray equipment includes units capable of radiography through steel in the range of thickness up to 1 1/2 - 2 inches with a single pulse. Highway department use of these devices can be expected to provide better quality, speed up inspection processes, and reduce cost by increasing the production rate and reducing the required number of inspection personnel. Operation of the field portable system requires only one man with no special training."

As the fabricators replace or substitute radiography with ultrasonic testing, it will be the Louisiana Department of Highways' responsibility to qualify the individuals performing the ultrasonic testing.

In order to prepare the Department to be capable to qualify ultrasonic testers, the investigators make the following recommendations:

1. An individual should be selected from existing personnel, or hired if necessary for the explicit purpose of thorough training in theory and application of ultrasonic testing. This training is available through various companies manufacturing ultrasonic equipment. Once this individual is trained, it will be the responsibility of the individual to keep abreast of advancements and improvements in the field of ultrasonic testing.
2. Once the Department has this trained individual or "authority", it will be the responsibility of this authority to work in liaison with the Training Unit of the Research and Development Section of the Louisiana Department of Highways to develop a training program in basic ultrasonics for the training of additional Highway personnel as ultrasonic qualifiers or supervisors.
3. It is recommended that the fabrication inspectors be offered the first opportunity to participate in the training program. However, it should be noted that it is not necessary for the individuals who qualify the ultrasonic testers to be versed in fabrication and welding procedures. The Bethlehem Steel Corporation generally draws upon groups of radiographers qualified 250-1500 or upon experienced draftsmen for their ultrasonic personnel.

Since most test laboratories offering ultrasonic inspection as one of their services use personnel licensed or certified by an outside agency, such as the American Society for Nondestructive Testing, or equivalent authority, it is not necessary that the Louisiana Department of Highways personnel become qualified ultrasonic inspectors. However, the Highway personnel should be versed well enough to detect irregularities or poor testing procedure used by qualified ultrasonic testers.

BIBLIOGRAPHY

1. Classroom Training Handbook, NDT, Ultrasonic Testing, General Dynamics, Convair Division, Copyright 1967.
2. Clavser, H. R., "The New Roles for NDT" Iron Age, July 23, 1970, pp. 52-56.
3. McMaster, et al. Nondestructive Tests for Welds in Highway Structures Transportation Research Center, Ohio State University, Project EES-261, August 31, 1970.
4. Olsson, Dexter A., Ultrasonic Testing of Structural Welds, Bethlehem Steel Corporation, Bethlehem, Pennsylvania, January 17, 1969.
5. Operation and Maintenance Instructions for Flaw/Thickness Tester, Sonoray Mark II, Models 301, 301A & 301B, Branson Instruments, Inc., Stanford, Connecticut.
6. Sproat, et al, Nondestructive Tests for Highway Structures, Report No. 261-1 Department of Welding Engineering, Ohio State University, March 31, 1967.
7. Ultrasonic Testing Inspection for Butt Welds in Highway and Railway Bridges U. S. Department of Transportation, Federal Highway Administration, Bureau of Public Roads.
8. Wehrmeister, "Use of Ultrasonic Testing in the Structural Steel Industry." Engineering Journal of American Institute of Steel Construction, Vol. 6 No. 2, pp. 55-59.

APPENDIX I

THE AMERICAN WELDING SOCIETY SPECIFICATIONS OF
WELDED HIGHWAY AND RAILWAY BRIDGES, APPENDIX C,
ULTRASONIC TESTING OF GROOVE WELDS

Appendix C

Ultrasonic Testing of Groove Welds

C101. General

(a) The procedures and standards set forth in this Appendix are to govern the ultrasonic testing of groove welds between the thicknesses of 5/16 and 8 inches, inclusive, when such testing is required by the stipulation of Art. 607 of these Specifications.

(b) Variations in testing procedure equipment and acceptance standards not included in this appendix may be used upon agreement with the Engineer. Such variations include other thicknesses, weld geometries, transducer sizes, frequencies, couplant, etc.

C102. Extent of Testing

(a) Information furnished to the bidders shall clearly identify the extent of ultrasonic testing by identifying the joints to be tested and by designating whether complete testing or random spot testing shall be performed.

(b) When complete testing is specified, the entire length of the weld in each designated joint shall be tested.

(c) When random spot testing is specified, the number of spots in each designated category of weld or the number required to be made in a stated length of weld shall be included in the information furnished to the bidders. Each spot tested shall cover at least 5 inches of the weld length or the complete length of the designated number of welds. When spot testing reveals discontinuities that require repair, two adjacent spots shall be tested. If discontinuities requiring repair are revealed in either of these, the whole of the weld in that welded joint shall be tested ultrasonically.

C103. Personnel Qualification

(a) Personnel performing ultrasonic testing shall be qualified in accordance with the American Society for Nondestructive Testing's Recommended Practice No. SNT-TC-1A and its Supplement C, Ultrasonic Testing Method. Only individuals qualified for NDT LEVEL I, working under the supervision of an individual qualified for NDT LEVEL II, or individuals qualified for NDT LEVEL II may perform ultrasonic weld testing.

C104. Ultrasonic Equipment

(a) The ultrasonic test instrument shall be of the pulse-echo type. It shall generate, receive, and present on a cathode-ray tube (CRT) screen pulses in the frequency range from one to six megahertz (MHz). The presentation on the CRT screen shall be the "video" type and characterized by a clean, crisp trace.

(b) The horizontal linearity of the test instrument shall be within plus or minus 5 percent over the linear range which shall include 90 percent of the sweep length presented on the CRT screen for the longest sound path to be used. The horizontal linearity shall be measured by the techniques prescribed by Section 7.9 of ASTM E317 except that the results may be tabulated rather than graphically presented.

(c) The test instrument shall be equipped with an internal electronic circuit or an external voltage transformer to stabilize the operating voltage. In either case, stabilization must be achieved within plus or minus 2 volts over an input voltage range of 90 to 130 volts.

(d) Test instruments utilizing battery power shall include internal stabilization resulting in no greater variation than plus or minus 1 decibel following warm-up during battery operating life. There shall be an alarm or meter incorporated in battery powered instruments to signal a drop in voltage prior to instrument shut-off because of battery exhaustion.

(e) The test instrument shall have a calibrated gain control (attenuator) adjustable in discrete 1 or 2 decibel steps over a range of at least 60 decibels. The accuracy of the gain control settings shall be within plus or minus one decibel and this accuracy shall be certified by the instrument manufacturer.

(f) The dynamic range of the instrument's CRT display shall be such that a difference of 1 db. of amplitude can be easily detectable on the CRT.

(g) Straight beam search unit transducers shall have an active area of not less than $\frac{1}{2}$ sq. in. nor more than 1 sq. in. The transducer shall be round or square. Transducer frequency shall be 2 to 2.5 MHz. Transducers shall be capable of resolving the three reflections as described in Figure C-4(1C).

(h) Angle beam search units shall consist of a transducer and an angle wedge. The unit may be comprised of the two separate elements or be an integral unit.

- (1) The transducer frequency shall be between 2 and 2.5 MHz, inclusive.
- (2) The transducer crystal may vary in size from $\frac{1}{2}$ to 1 inch in width and from $\frac{1}{2}$ to $\frac{13}{16}$ inches in height. (see sketch)

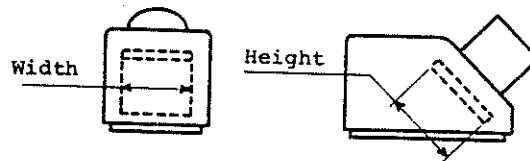

- (3) The search unit shall produce a sound beam in the material being tested within plus or minus 2 degrees of the following proper angle: 70°, 60°, or 45°, as described in Figure C-4(IIB).
- (4) Each search unit shall be marked to clearly indicate the frequency of the transducer, nominal angle of refraction, and index point. The index point location procedure is described in Figure C-4(IIA).
- (5) Internal reflections from the search unit, with a screen presentation higher than the horizontal reference line, appearing on the screen to the right of the sound entry point shall not occur beyond $\frac{1}{2}$ inch equivalent distance in steel when the sensitivity is set as follows: 20 db. more than that required to produce a maximized horizontal reference line height indication from the 1.5 mm (.06") diameter hole in the International Institute of Welding (IIW) reference block. (Figure C-1)
- (6) The dimensions of the search unit shall be such that the closeness of approach to the weld reinforcement shall not exceed the requirements of Figure C-4(IIF), Approach Distance of Search Unit. The search unit shall be positioned for maximum indication from the .06 inch diameter hole in the (IIW) calibration block.
- (7) The combination of search unit and instrument shall resolve the three holes in the resolution test block shown in Figure C-3. The search unit position is described in Figure C-4(IIE). The resolution shall be evaluated with the instrument controls set at normal test settings and with indications from the holes brought to mid screen height.

C105. Calibration Standards

(a) International Institute of Welding's (IIW) ultrasonic reference block, shown in Figure C-1, shall be the standard, used for both distance and sensitivity calibration. More portable reference blocks of other design may be used provided they meet the requirements of this specification and are referenced back to the IIW Block. Approved designs are shown in Figure C-2.

(b) Use of a "corner" reflector for calibration purposes is prohibited.

C106. Equipment Calibration

(a) The instrument's gain control (attenuator) shall be checked for correct calibration at two month intervals in accordance with a procedure recommended by the instrument's manufacturer and shall meet the requirements of Par. C104 (e).

(b) Horizontal linearity shall be checked after each 40 hours of instrument use by the techniques prescribed in Par. C104 (b).

(c) With the use of an approved calibration block, each angle beam search unit shall be checked after each 8 hours of use to determine that the contact face is flat, that the sound entry point is correct, and that the beam angle is within the permitted plus or minus 2 degrees tolerance. Search units which do not meet these requirements shall be corrected or replaced.

C107. Calibration for Testing

(a) Calibration for sensitivity and horizontal sweep (distance) shall be made by the ultrasonic operator just prior to and at the location of testing of each weld and at intervals of 30 minutes as testing proceeds. Recalibration shall be made each time there is a change of operators, when new batteries are installed, or when equipment operating from a 110 volt source is connected to a different power outlet.

(b) Calibration for straight beam testing shall be performed as follows:

- (1) The horizontal sweep shall be adjusted for distance calibration to present the equivalent of at least two plate thicknesses on the CRT screen.
- (2) The sensitivity shall be adjusted at a location free of indications so that the first back reflection from the far side of the plate will be 80 to 100 percent of full screen height. For this purpose, the reject (clipping) control shall be turned off.

- (c) Calibration for angle beam testing shall be performed as follows:
- (1) The horizontal sweep shall be adjusted to represent the actual sound path length by using acceptable distance calibration blocks shown in Figure C-1 and C-2. This distance calibration shall be made using either the 5 inch scale or 10 inch scale on the CRT screen, whichever is appropriate, unless joint configuration or thickness prevents full examination of the weld at either of these settings. The search unit position is described in Figure C-4(IIC).
 - (2) With the unit adjusted to conform with the requirements of Article C104, the sensitivity shall be adjusted by the use of the gain control (attenuator) so that a horizontal reference level trace deflection results on the CRT screen with the maximum indication from the 0.06 inch diameter hole in the IIW block or from the equivalent reference reflector in other acceptable calibration blocks. The search unit position is described in Figure C-4(IID). This basic sensitivity then becomes the zero reference level for discontinuity evaluation and shall be recorded on the ultrasonic test reports under "Reference Level", "b", (Figure C-6)

C108. Testing Procedure

- (a) A "Y" accompanied with a weld identification number shall be clearly marked on the material adjacent to the weld at the left end of each weld which is ultrasonically tested. This identification number serves as an orientation direction for weld discontinuity location and as the "Report Number" on Report Form shown in Figure C-6.
- (b) All surfaces to which a search unit is applied shall be free of weld spatter, dirt, grease, oil and loose scale, and shall have a contour permitting intimate coupling. Tight layers of paint need not be removed unless the thickness exceeds 10 mils.
- (c) A couplant shall be used between the search unit and the material. The couplant shall be either glycerin with a wetting agent added if needed, or a cellulose gum and water mixture of a suitable consistency. Light machine oil or equivalent may be used for couplant on calibration blocks.
- (d) The entire base metal through which ultrasound must travel to test the weld shall be tested for laminar reflectors using a straight beam search unit conforming to the requirement Par. C104 (g), and calibrated in accordance with Par. C107 (b). If any area of base metal exhibits total

loss of back reflection and is located in a position that would interfere with the normal weld scanning procedure, the following alternate weld scanning procedure shall be used.

- (1) Determine the area of the laminar reflector, its depth from the surface, and record the data on the Ultrasonic Test Report. (Figure C-6)
- (2) Grind both faces of the weld flush if necessary to attain full ultrasonic coverage.
- (3) Using applicable scanning patterns shown in Figure C-5, examine the inaccessible part of the weld in order to attain full weld evaluation.

(e) Welds shall be tested using an angle beam search unit conforming to the requirements of Par. C104 (h) with the instrument calibrated in accordance with Par. C107 (c) using the angle as shown in Table C-1. Following calibration and during testing, the only instrument adjustment permitted is in the sensitivity level adjustment with the calibrated gain control or attenuator. Sensitivity shall be increased from the reference level for weld scanning in accordance with Table C-2 (bottom).

- (1) All welds shall be scanned from both sides on the same face where mechanically possible, for longitudinal and transverse discontinuities using the applicable scanning pattern or patterns shown in Figure C-5.
- (2) The testing angle shall be as shown in Table C-1 and the transducer size must conform to Par. C104 (h) (2).
- (3) When a discontinuity indication appears on the screen, the maximum attainable indication from the discontinuity shall be adjusted to produce a horizontal reference level trace deflection on the CRT screen. This adjustment shall be made with the calibrated gain control or attenuator, and the instrument reading, in decibels, shall be recorded on the Ultrasonic Test Report, Figure C-6, under the heading "Defect Level", "a".
- (4) The "Attenuation Factor", "c" on the test report (Figure C-6) is attained by subtracting 1 inch from the sound path distance and multiplying the remainder by two.
- (5) The "Defect Rating", "d" on test report (Figure C-6) is the difference between the "Reference Level" and the "Defect Level" after the "Defect Level" has been corrected by the "Attenuation Factor".

Instruments with gain in DB: $a-b-c = d$

Instruments with attenuation in DB: $b-a-c = d$

- (6) The length of a discontinuity as entered under "Defect Length" on the test report (Figure C-6) shall be determined by locating the points at each end at which the indication amplitude drops 6 decibels, and measuring between the points from the center of the transducer at one end to the center of the transducer at the other end.
- (7) Any weld discontinuity shall be accepted or rejected on the basis of its defect rating and its length in accordance with Table C-2. Only those discontinuities which are rejectable need be recorded on the test report (Figure C-6) and should be so noted under the heading of "Defect Evaluation".
- (f) Each rejectable discontinuity shall be indicated on the weld by a mark directly over the discontinuity for its entire length. The depth from the surface and type of discontinuity shall be noted on nearby base metal.
- (g) Welds found unacceptable by ultrasonic testing shall be repaired by methods permitted by Article 308 of these Specifications. Repaired welds shall be retested ultrasonically and additional report form (Figure C-6) completed.

C109. Preparation and Disposition of Reports

- (a) A Report Form which clearly identifies the work and the area of inspection shall be completed by the ultrasonic inspector at the time of inspection. The Report Form for welds which are acceptable need only contain sufficient information to identify the weld, the inspector (signature), and the acceptability of the weld. An example of such a form is shown on Figure C-6.
- (b) Prior to acceptance of a weld subject to ultrasonic inspection by the Contractor for the Owner, all of the Report Forms pertaining to the weld, including any that show unacceptable quality prior to repair, shall be submitted to the inspector.
- (c) A full set of completed Report Forms of welds subject to ultrasonic inspection by the Contractor for the Owner, including any that show unacceptable quality prior to repair, shall be delivered to the Owner upon completion of the work. The Contractor's obligation to retain ultrasonic reports shall cease upon delivery of this full set to the Owner or, in the event that delivery is not required, at the end of one full year after completion of the Contractor's work.

TABLE C-1

WELD TYPE	PROCEDURE CHART										
	WELD OR MATERIAL THICKNESS										
	5/16 to 1 1/2	>1 1/2 to 1 3/4	>1 3/4 to 2 1/2	>2 1/2 to 3 1/2	>3 1/2 to 4 1/2	>4 1/2 to 5	>5 to 6 1/2	>6 1/2 to 7	>7 to 8		
BUTT	1 0	1 2	1G or 4	2 3	2 3	2 3	2 3	2 3	2 3	2 3	2 3
TEE	1 0	1 3	4 3	5 3	7 X3	10 X3	11 X3	12 or 13	12 or 13	12 or 13	12 or 13
CORNER	1 0	1 X3	1G or 4	1G or 5	6 or 7 X3	8 or 10 X3	9 or 11 X3	13 or 14 X3	13 or 14 X3	13 or 14 X3	13 or 14 X3
ELECTROGAS & ELECTROSLAG	1 0	1 0	1G or 4	1G or 5	6 or 7 P3	15 P3	15 P3	15 P3	15 P3	15 P3	15 P3

ALL EXAMINATIONS ARE TO BE MADE FROM FACE "A" UNLESS NOTED, AND SCANNED FROM BOTH SIDES OF WELD (ON FACE "A") WHERE MECHANICALLY POSSIBLE. ALL EXAMINATIONS ARE TO BE MADE IN NODE 1 WHERE POSSIBLE, BUT NOT BEYOND NODE 11.

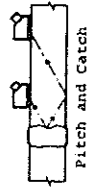
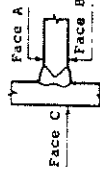
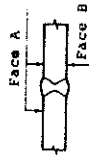

LEGEND

- X - Check from Face "C".
- G - Grind Weld Face Flush.
- O - Not Required.
- "A" Face - the face of the material from which the initial scanning is done (on Tees and Corners follow above sketches).
- "B" Face - opposite the "A" Face (same plate).
- "C" Face - the face opposite the weld on the connecting member on Tee or Corner joints.
- ° - Required only where reference level indication of defect is noted in fusion area while searching at scanning amplitude with primary procedure selected from first column.
- °° - Use 15 or 20 inch screen distance calibration.
- P - Pitch and catch to be conducted with only 45° or 70° transducers of equal specification, both facing weld. (Transducers preferably held in a fixture to control positioning-see sketch.)

NOTE:

PROCEDURES 6, 8, 9, 12 OR 14 MUST BE FOLLOWED WHEN TESTING WELDS WHICH HAVE BEEN GROUND FLUSH. THE NEED FOR GRINDING MAY EITHER BE DONE TO SATISFY CONTRACT REQUIREMENTS, OR AT THE OPTION OF THE PRODUCER TO PROVIDE A MORE FAVORABLE WORKING CONDITION. IN ORDER TO USE THESE PROCEDURES FOR TRANSITION WELDS, FACE "A" MUST BE SINGLE PLANE.

**EXAMPLE: BUTT WELD IN 4" MATERIAL
NO. 6 PROCEDURE**

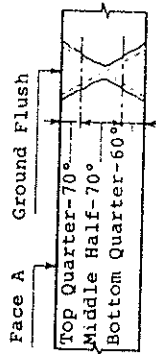

PROCEDURE LEGEND			
AREA OF WELD THICKNESS			
No.	Top Quarter	Middle Half	Bottom Quarter
1	70°	70°	70°
2	60°	60°	60°
3	45°	45°	45°
4	60°	70°	70°
5	45°	70°	70°
6	70°G A	70°	60°
7	60° B	70°	60°
8	70°G A	60°	60°
9	70°G A	60°	45°
10	60° B	60°	60°
11	45° B	60°	45°
12	70°G A	45°	70°G B
13	45° B	45°	45°
14	70°G A	45°	45°
15	70° A	70°A B	70° B

LEGEND

- X — Check from Face "C"
- "A" Face — the face of the material from which the initial scanning is done (on Tees and Corners follow above sketches).
- "B" Face — opposite the "A" Face (same plate).
- "C" Face — the face opposite the weld on the connecting member on Tee or Corner joints.
- ° — Required only where reference level indication of defect is noted in fusion area while searching at scanning amplitude with primary procedure selected from first column.
- °° — Use 15 or 20 inch screen distance calibration.
- P — Pitch and catch to be conducted with only 45° or 70° transducers of equal specification, both facing weld. (Transducers preferably held in a fixture to control positioning-see sketch.)
- G — Grind Weld Face Flush.
- O — Not Required.

TABLE C2 — HIGHWAY AND RAILWAY BRIDGES

MINIMUM ACCEPTANCE LEVELS (DECIBELS)		WELD THICKNESS AND TRANSDUCER ANGLE												
REFLECTOR SEVERITY	5/16 to 3/4	>3/4 to 1 1/2		>1 1/2 to 2 1/2		>2 1/2 to 4		>4 to 6		>6 to 8				
		70°	70°	60°	45°	70°	60°	45°	70°	60°	45°	70°	60°	45°
Large Reflectors	+14	+9	+5	+8	+10	+2	+5	+7	-1	+2	+4	-3	0	+2
Small Reflectors	+15	+10	+7	+10	+12	+4	+7	+9	+1	+4	+6	-1	+2	+4
Minor Reflectors	+16	+11	+9	+12	+14	+6	+9	+11	+3	+6	+8	+1	+4	+6

LARGE REFLECTORS:

Any discontinuity, regardless of length, having a more serious rating (smaller number) than this level shall be rejected.

SMALL REFLECTORS:

Any discontinuity longer than 3/4" having a more serious rating (smaller number) than this level shall be rejected.

MINOR REFLECTORS:

Only those discontinuities exceeding 2" in length and having a more serious rating (smaller number) than this level shall be rejected.

NOTES:

- (1) Discontinuities which have a more serious rating than those of "Minor Reflectors", shall be separated by at least 2L, L being the length of the larger discontinuity.
- (2) Discontinuities which have a more serious rating than those of "Minor Reflectors" shall not begin at a distance smaller than 2L from the end of the weld, L being the discontinuity length.
- (3) Discontinuities in the root-land area of full penetration double Vee, double "j" and double "u" welds detected at "Scanning Level" shall be evaluated at an acceptance level 4 db. more sensitive than prescribed by this table; i.e., add plus four units to the number in the table.
- (4) Discontinuities which have a more serious rating than those of "Minor Reflectors" and which exceed 3/4" in length are permitted only in the middle half of the weld thickness.

SCANNING LEVELS	
SOUND PATH DISTANCE	ABOVE ZERO REFERENCE
to 2 1/2"	+20 db
> 2 1/2 - 5"	+25 db
> 5 - 10"	+35 db
> 10 - 15"	+45 db

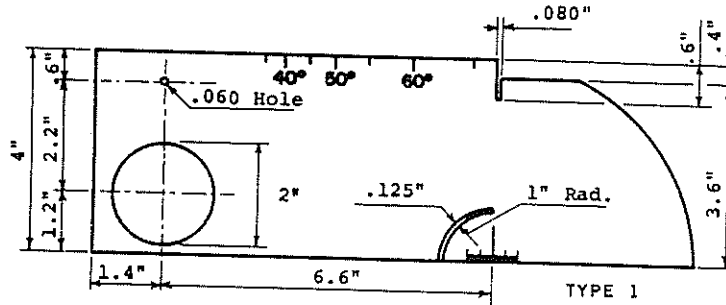

NOTE:
OTHER IIW APPROVED REFERENCE
BLOCKS WITH SLIGHTLY DIFFERENT
DIMENSIONS OR DISTANCE CALI-
BRATION SLOT FEATURES ARE
PERMISSIBLE.

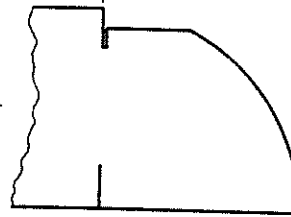

TYPE 2

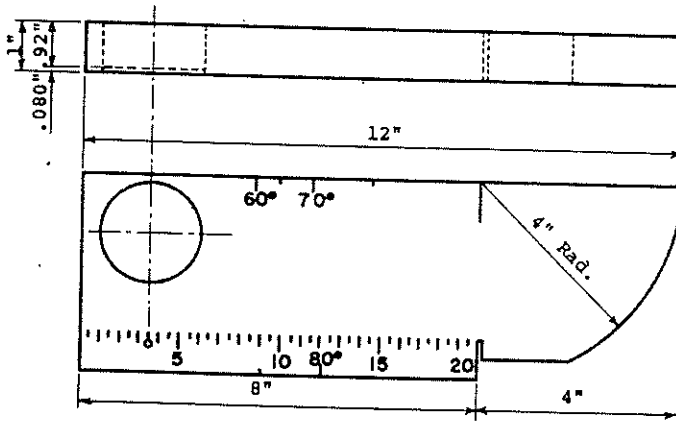

SEE FIGURE C-4 FOR
APPLICATIONS

MATERIAL: ASTM A36 STEEL
OR EQUIVALENT

Fig. C-1 — International Institute of Welding (IIW)
Ultrasonic Reference Block

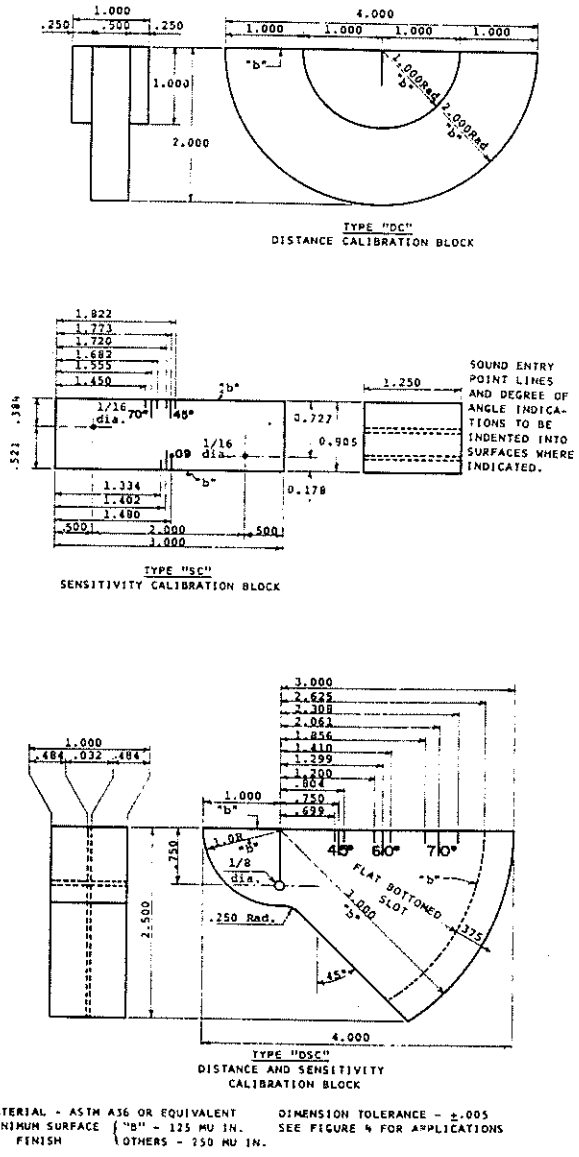

Fig. C-2 — Other Calibration Blocks

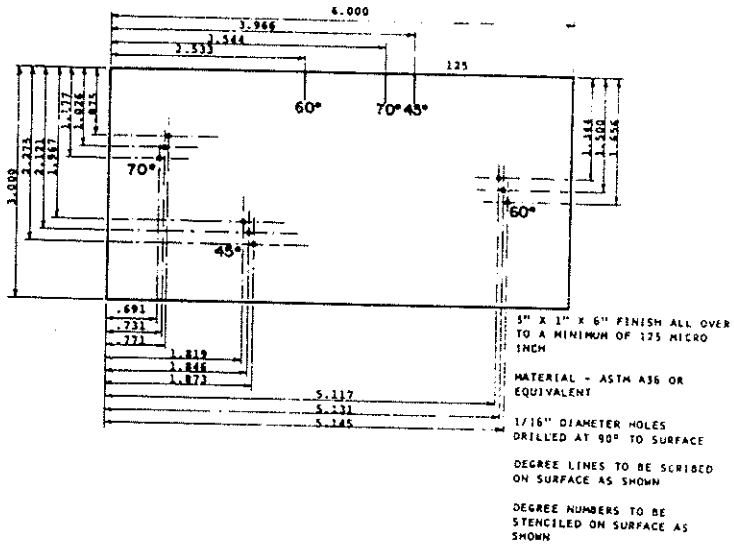

Fig. C-3 — Resolution Test Block

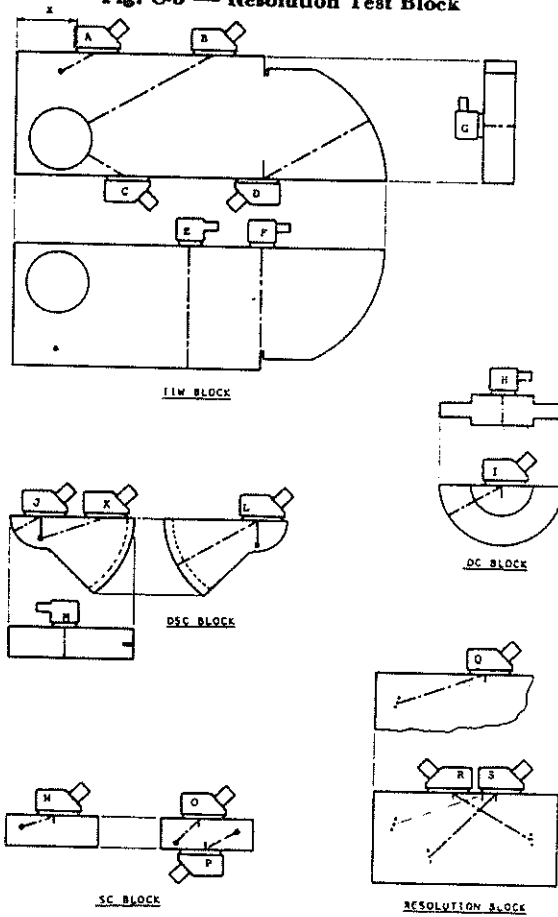

Fig. C-4 — Transducer Positions (Typical)

The Calibration of the Ultrasonic Unit with the IIW or Other Approved Calibration Blocks Shown on Figures C-1 and C-2

I. Longitudinal Mode

A. Distance Calibration

1. Transducer in position "G" on the IIW block, position "H" on the DC block, or position "M" on the DSC block.
2. Adjust instrument to produce indications at 1", 2", 3", 4", etc. on the CRT.

B. Amplitude

1. Transducer in position "G" on the IIW block, position "H" on the DC block, or position "M" on the DSC block.
2. Adjust gain until maximized indication from the first back reflection attains 40% - 70% screen height.

C. Resolution

1. Transducer in position "F" on the IIW block.
2. Transducer and instrument should resolve all three distances.

II. Shear Wave Mode (Transverse)

A. To locate or check the transducer sound entry point (Index Point)

1. Transducer in position "D" on the IIW block, position "J" or "L" on the DSC block, or "I" on the DC block.
2. Move transducer until signal from the radius is maximized.
3. The point on the transducer which is in line with the line on the calibration block is indicative of the point of sound entry.

B. To check or determine the transducers sound path angle.

1. Transducer in position "B" on IIW block for angles 40° through 60°.
2. Transducer in position "C" on IIW block for angles 60° through 70°.
3. Transducer in position "K" on DSC block for 45° through 70°.
4. Transducer in position "N" on SC block for 70° Angle.
5. Transducer in position "O" on SC block for 45° Angle.
6. Transducer in position "P" on SC block for 60° Angle.
7. Move the transducer back and forth over the line indicative of the transducer angle until the signal from the radius is maximized, then compare the sound entry point on the transducer with the angle mark on the calibration block. (Tolerance $\pm 2^\circ$)

- C. Distance Calibration procedure
 1. Transducer in position "D" on the IIW (any angle).
 2. Adjust the instrument to attain indications at 4 inches and 8 or 9 inches on the CRT, 9" on Type 1 block or 8" on Type 2 block.
 3. Transducer in position "J" or "L" on the DSC block (any angle).
 4. Adjust the instrument to attain indications at 1", 5" and 9" on the CRT in the "J" position.
 5. Adjust the instrument to attain indications at 3" and 7" on the CRT in the "L" position.
 6. Transducer in position "I" on the DC block (any angle).
 7. Adjust the instrument to attain indications at 1", 2", 3", 4", etc., on the CRT.

- D. Amplitude or sensitivity calibration procedure
 1. Transducer in position "A" on the IIW block (any angle).
 2. Adjust the maximized signal from the .060" hole to attain a horizontal reference line height indication.
 3. Transducer in position "L" on the DSC block (any angle).
 4. Adjust the maximized signal from the 1/32" slot to attain a horizontal reference line height indication.
 5. Transducer on the SC block, position "N" for 70° Angle, position "O" for 45° Angle, or position "P" for 60° Angle.
 6. Adjust the maximized signal from the 1/16" hole to attain a horizontal reference line height indication.
 7. This decibel reading is used as the "Reference Level" "b" reading on the "Test Report" sheet (Figure 6).

- E. Resolution
 1. Transducer on Resolution block, position "Q" for 70° Angle, position "R" for 60° Angle, or position "S" for 45° Angle.
 2. Transducer and instrument shall resolve the three test holes.

- F. Approach Distance of Search Unit
 1. The minimum allowable distance, "X", between the toe of the search unit and the edge of IIW block shall be as follows:
 - for 70° transducer "X" = 2".
 - for 60° transducer "X" = 1⁵/₈".
 - for 45° transducer "X" = 1".

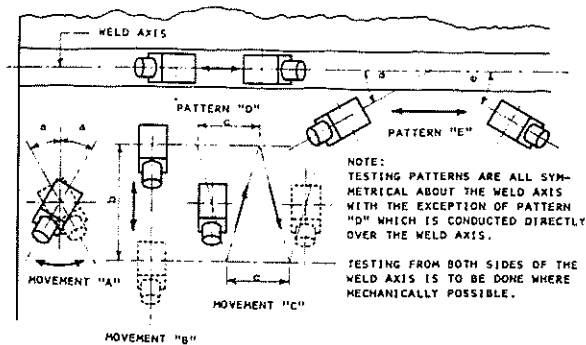

Fig. C-5 — Plan View of Welded Plate

Scanning Patterns

1. Longitudinal Defects

(a) Scanning Movement "A"

(1) Rotation Angle "a" = 10°.

(b) Scanning Movement "B"

(1) Scanning distance "b" shall be such that the full section of weld being tested is covered.

(c) Scanning Movement "C"

(1) Progression Distance "c" shall be approximately one-half the transducer width.

NOTE: Movements "A", "B", and "C" are combined into one scanning pattern.

2. Transverse Defects

(a) Scanning Pattern "D" (when welds are ground flush)

(b) Scanning Pattern "E" (when weld reinforcement is not ground flush)

(1) Scanning angle "e" = 15° maximum.

NOTE: Scanning Pattern is to be such that full weld section is covered.

3. Electroslag or Electrogas Welds (Additional Scanning Pattern)

(a) Scanning Pattern "E"

(1) Search Unit Rotation Angle "e" between 45° and 60°.

NOTE: Scanning Pattern is to be such that full weld section is covered.

ULTRASONIC TEST REPORT

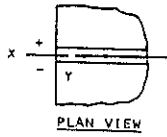

WELD IDENTIFICATION _____
 MATERIAL THICKNESS _____
 WELD JOINT AWS _____
 WELD PROCESS _____
 REMARKS _____

LINE NUMBER	DEFECT NUMBER	TRANSDUCER ANGLE	NODE #	DECIBELS				DEFECT				DEFECT EVALUATION	REMARKS	
				DEFECT LEVEL A	REFERENCE LEVEL B	ATTENUAT. FACTOR C	DEFECT RATING D	LENGTH	ANGULAR DISTANCE (SOUND PATH)	DEPTH FROM "A" SURFACE	DISTANCE			
										FROM "x"	FROM "y"			
1														
2														
3														
4														
5														
6														
7														
8														
9														
10														
11														
12														

NOTES:

- (1) #. USE NODE I OR II - SEE GLOSSARY OF TERMS
- (2) IN ORDER TO ATTAIN "RATING D":
 (A) WITH INSTRUMENTS WITH GAIN CONTROL, USE THE FORMULA: $A - B - C = D$
 (B) WITH INSTRUMENTS WITH ATTENUATION CONTROL, USE THE FORMULA: $B - A - C = D$
 (C) A + OR - SIGN MUST ACCOMPANY THE "D" FIGURE UNLESS "D" IS EQUAL TO ZERO
- (3) DISTANCE FROM X IS USED IN DESCRIBING THE LOCATION OF A WELD DISCONTINUITY IN A DIRECTION PERPENDICULAR TO THE WELD REFERENCE LINE. UNLESS THIS FIGURE IS ZERO, A + OR - SIGN MUST ACCOMPANY IT.
- (4) DISTANCE FROM Y IS USED IN DESCRIBING THE LOCATION OF WELD DISCONTINUITY IN A DIRECTION PARALLEL TO THE WELD REFERENCE LINE. THIS FIGURE IS ATTAINED BY MEASURING THE DISTANCE FROM THE "Y" END OF THE WELD TO THE BEGINNING OF SAID DISCONTINUITY.
- (5) MAKE SEPARATE REPORT FOLLOWING REPAIRS. (SUFFIX REPORT NO. WITH R1, R2, ETC.)

INSPECTED BY _____

DATE _____
 CONTRACT NO. _____
 REPORT NO. _____
 SHEET NO. _____ OF _____

Fig. C-6 — Sample of Ultrasonic Test Report

APPENDIX 2
GLOSSARY OF ULTRASONIC TERMS



GLOSSARY OF ULTRASONIC TESTING TERMS

AMPLITUDE - 1. When referring to a trace deflection on the instrument screen it is the vertical height of the deflected trace.

2. When referring to wave motion, it is the maximum displacement of the particles of the medium from rest.

AMPLITUDE LENGTH REJECTION LEVEL - The length of defect permitted for various "Decibel Ratings" as associated with throat thickness.

ANGLE BEAM TESTING - (See SHEAR WAVE TESTING)

An ultrasonic testing technique in which the transducer is at an angle to the test surface and the ultrasound (normally shear wave) enters the material at an angle to the test surface.

ANGLE OF INCIDENCE - The angle between the original direction of the ultrasonic beam and an imaginary line drawn perpendicular to the reflecting surface of an interface.

ANGLE OF REFLECTION - The angle between a reflected ultrasonic beam and a line drawn perpendicular to the reflecting surface.

ANGLE OF REFRACTION - The angle formed between the ultrasonic beam as it enters a medium of different characteristic than the one from which it came and a line drawn perpendicular to the interface between the two media.

ATTENUATION - In general, the loss of sound energy within a testing system. Within material being tested, sound energy losses caused by the internal structure of the material, and not by part geometry.

BACK REFLECTION - An indication on the CRT of a reflection of ultrasound from the boundary of the test piece.

BEAM - The path of the principal portion of the ultrasound.

CALIBRATION - The process of comparing a test system with a standard, to determine accuracy, to establish a required sensitivity level or to establish an accurate distance scale.

CATHODE RAY TUBE - CRT) An electron tube in which a beam of electrons from the cathode is used to reproduce an image on a fluorescent screen at the face of the tube.

COUPLANT - (Coupling Medium) Any material (usually a liquid or semi-liquid) used between the face of the search unit and the test surface to permit or improve transmission of the ultrasound from the search unit to the material under test.

CRYSTAL - A transducer made of a single crystal of a material, usually quartz. Often mistakenly used to refer to a search unit or to transducers in general.

CYCLE - (Referring to wave motion) One complete oscillation of a repetitive wave.

DECIBEL - A measurable unit of sound amplitude.

DECIBEL RATING - A value of amplitude of signal varying up or down from the standard reference gain setting, and corrected for distance attenuation.

DEFECT - A discontinuity of rejectable size.

DEFECT LEVEL - The calibrated gain control or attenuation control reading obtained from a discontinuity.

DEFECT RATING - The decibel reading in relation to the zero, reference level after being corrected for attenuation.

DISCONTINUITY - A general term applied to any internal obstacle to the passage of ultrasound within the test piece.

FIRST BACK REFLECTION - Indication on the instrument screen of the first reflection from the far boundary of the material under test.

FREQUENCY - (In regard to wave motion) The frequency of a wave motion is the number of complete waves that pass a point per second.

Where:

$$f = \frac{V}{L}$$

f = frequency

V = velocity

L = wave length

INDICATION - A sweep deflection from the base line on the CRT, other than initial pulse interface signals, or back reflection.

INITIAL PULSE - First sweep deflection on the left side of the viewing screen. Caused by reflection within the search unit and/or test surface.

LONGITUDINAL DISCONTINUITY - A weld discontinuity whose major dimension is in a direction parallel to the weld axis "X".

LONGITUDINAL WAVE - A wave form in which the particle motion is in the direction of wave travel.

LONGITUDINAL WAVE TESTING - An ultrasonic testing technique, normally using straight beam methods, in which longitudinal waves are the predominant wave form.

MEGACYCLE - (Megahertz) One million cycles.

NODE - The distance of the shear wave travels in a straight line before being reflected by the surface of the material being tested. See sketch below for node identification.

ORIENTATION - Angular relationship of the reflecting surface of a discontinuity with respect to the test surface.

PIEZOELECTRIC EFFECT - The generation of electrical energy by the application of mechanical stress to certain types of crystals and, similarly, the generation of mechanical stress by the application of electrical energy.

PROBE (See SEARCH UNIT)

PULSE - A short burst of energy, sonic or electrical.

PULSE REPETITION RATE - The rate at which the pulser sends out individual pulses. (Usually 50 to 2,000 times per second).

REFERENCE LEVEL - The decibel reading attained from a horizontal reference line height indication of a reference reflector.

REFERENCE REFLECTOR - The standard reflector contained in the IIW reference block or other approved blocks.

REFLECTING SURFACE - Boundary of a part under test which will cause a reflection of any pulse which strikes it. Any discontinuity of sufficient size also presents a reflecting surface to the pulse.

REFLECTION - The phenomenon by which a pulse strikes a boundary and changes direction.

REFRACTION - Refraction of a wave is the change of angle of the wave which results from the passage of a wave from one medium to another medium having different properties.

REJECTABLE DISCONTINUITY (Defect) - A reflector of sufficient size to produce a signal (Decibel Rating) equal to or greater than the "Reject" values specified.

SCANNING (Search) The moving of the search unit (or units) along the test surface.

SCANNING LEVEL - The decibel reading setting during scanning.

SEARCH UNIT - The unit containing the transducer, its associated parts and accessories.

SHEAR WAVES - A wave in which the particle motion is perpendicular to the direction of wave travel.

SHEAR WAVE TESTING - An ultrasonic testing technique normally using angle beam methods, in which shear waves are the predominant wave form.

SOUND BEAM DISTANCE - The distance between the search unit steel interface and the reflector (as calibrated).

STRAIGHT BEAM TESTING - An ultrasonic testing technique in which the search unit surface is parallel to the test surface and the ultrasound enters the material being tested in a direction perpendicular to the test surface.

SURFACE CONDITIONING - Preparation of a surface by mechanical means to obtain a test surface satisfactory for ultrasonic testing. This is necessary in some cases to obtain satisfactory coupling between the search unit and the test surface.

TEST BLOCK - A block of material similar to that being tested used to establish trace deflection distance and amplitude calibration.

TEST SURFACE - Any boundary of material under test on which the search unit is placed to transmit ultrasound into the material.

THROUGH TRANSMISSION - A test method in which the ultrasound emitted by one search unit is directed, and receive by, another search unit. The ratio between quantity of ultrasound sent and received is a measure of the soundness of quality of material being tested.

TRANSDUCER - In ultrasonic systems, a piece of piezoelectric material used to reversably transform electrical and mechanical energy.

TRANSMITTED PULSE - The wave train introduced into the material to be tested.

TRANSVERSE DISCONTINUITY - A weld discontinuity whose major dimension is in a direction perpendicular to the weld axis "X".

ULTRASONICS - That branch of the science of physics which deals with the study of vibrational waves of a frequency range above the hearing range of the normal human ear. The term, therefore, includes all those waves of more than approximately 20,000 cycles/second.

ULTRASOUND (Ultrasonic Vibration or Ultrasonic Waves) - Vibrational waves of a frequency above the hearing range of the normal human ear are referred to as ultrasound. The term, therefore, includes all those waves of a frequency more than approximately 20,000 cycles/second.

VELOCITY - The speed with which sound waves travel through a material.

WEDGE TESTING - A term sometimes used as a synonym for angle beam testing.

WETTING AGENT - A material added to a couplant which causes the couplant to wet the test surface better, thereby promoting coupling efficiency.

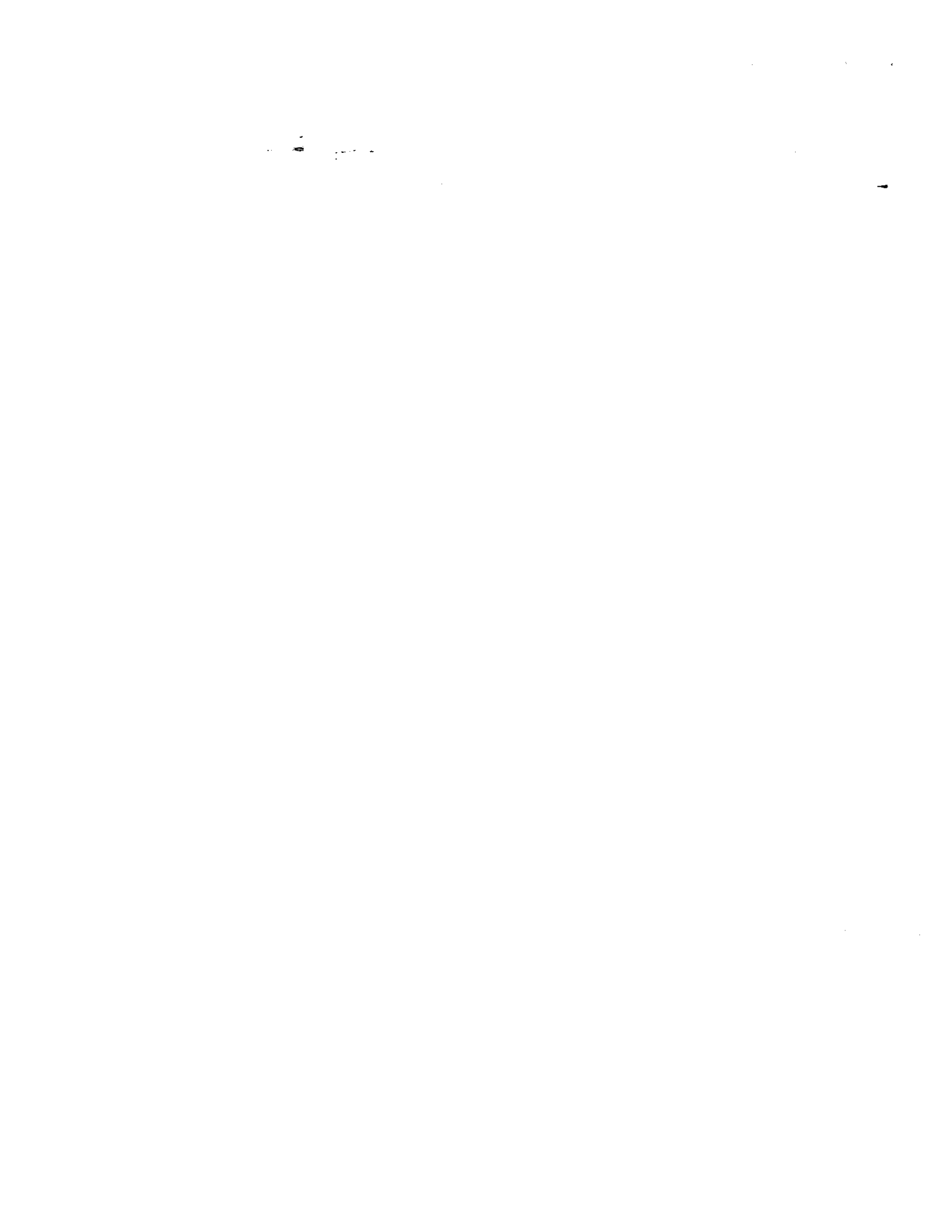

APPENDIX 3

TABLE 3 - COMPARISON OF DEFECT LENGTH AND DEPTH
AS DETERMINED BY ULTRASONIC TESTING TO ACTUAL DEFECT
LENGTH AND DEPTH AS DETERMINED BY MACHINING

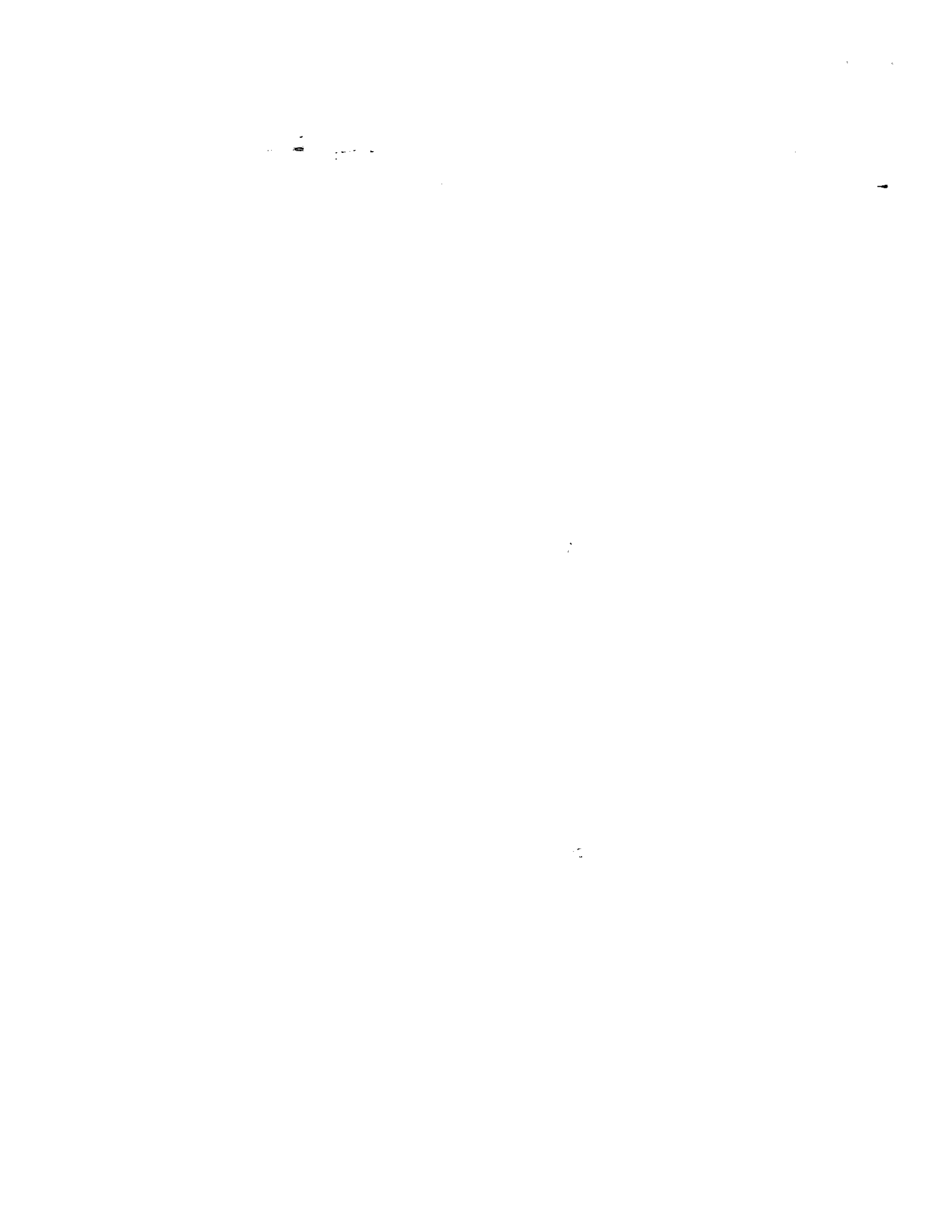

TABLE 3

Test Number	Plate Thickness	Ultrasonic Data					Defect Rating (Incl. Atten. *)	Radiographic Data			Excavation Results			
		Angle	Angular Distance	Length	Depth	Defect Length		Defect Type	Defect Length	Defect Depth	Defect Type	Defect Length	Defect Depth	Defect Type
1	3/8	70°	0.9	0.2	0.3	+10	0.4	Porosity	-	-	-	-	-	-
2	3/8	70°	1.0	0.7	0.4	-8	0.4	Slag	0.4	0.4	0.4	0.4	Slag	0.4
3	3/8	70°	0.8	0.5	0.3	+4	0.2	Slag	0.1	0.3	0.3	0.3	Pin Hole	0.3
4	3/8	70°	0.5	0.3	0.2	+11	0.1	Porosity	0.1	0.2	0.2	0.2	Pin Hole	0.2
5	1	70°	1.8	0.6	0.7	+9	-	-	0.3	0.7	0.7	0.7	Slag	0.7
7	1	70°	0.4	0.4	0.1	-3	0.7	Slag	0.4	0.1	0.1	0.1	Porosity Line	0.1
10	1 1/2	70°	1.4	0.7	0.5	+8	Not Shown	Not Shown	0.5	0.5	0.5	0.5	Pin Hole with Crack	0.5
11	1	70°	1.3	0.8	0.5	+6	Not Shown	Not Shown	0.8	0.5	0.5	0.5	Slag	0.5
12	3/8	70°	0.7	0.8	0.3	+3	Not Shown	Not Shown	0.7	0.3	0.3	0.3	Slag and Porosity	0.3
13	3/8	70°	0.5	0.5	0.2	+4	0.5	Slag	0.5	0.2	0.2	0.2	Slag	0.2
17	3/8	70°	0.4	Full Length	0.2	-16	Full Length	Lack of Penetration Length	0.2	0.2	0.2	0.2	Lack of Penetration	0.2
18	3/8	70°	0.8	0.6	0.3	+6	0.5	Porosity	0.5	0.3	0.3	0.3	Porosity	0.3
19	3/8	70°	0.8	0.5	0.3	-2	Not Shown	Not Shown	0.5	0.3	0.3	0.3	Crack	0.3

* The lower the defect rating the more severe the defect.

TABLE 3

Test Number	Plate Thickness	Ultrasonic Data					Radiographic Data			Excavation Results		
		Angle	Angular Distance	Length	Depth	Defect Rating (Incl. Atten.)*	Defect Length	Defect Type	Defect Length	Defect Depth	Defect Type	
20	3/8	70°	0.8	0.5	0.3	+7	Not Shown		0.5	0.3	Slag	
21	3/8	70°	0.1	0.7	0.1	-4	0.5	Slag	0.7	0.1	Slag and Porosity	
22	1	70°	0.5	0.8	0.2	+8	0.5	Slag	0.5	0.2	Slag and Crack	
23	1	70°	1.9	0.2	0.7	+5	0.1	Slag	0.1	0.7	Slag	
30	3/8	70°	0.3	0.4	0.1	+2	0.4	Slag	0.4	0.1	Slag	
33	1	70°	3.0	3.0	0.4	-4	No Radiograph		3.0	0.4	Lack of Penetration	
34	1	70°	3.2	0.8	0.8	-6	No Radiograph		0.8	0.8	Slag	
35	1	70°	2.9	1.5	0.9	-6	No Radiograph		1.2	0.9	Crack	
38	1	70°	3.6	0.8	0.6	+1	No Radiograph		0.8	0.6	Fusion	
46	1	70°	2.8	0.8	0.6	-10	0.8	Slag	0.8	0.6	Large Slag	
50	3/8	70°	1.5	0.4	0.2	+9	0.5	Slag	0.4	0.2	Slag	
56	3/8	70°	0.7	0.6	0.2	+6	0.3	Slag	0.6	0.2	Slag	
60	3/8	70°	0.8	1.2	0.3	-6	1.0	Large Porosity	1.2	0.3	Large Porosity	

* The lower the defect rating the more severe the defect.

TABLE 3

Test Number	Plate Thickness	Ultrasonic Data				Defect Rating (Incl. Atten. %)	Radiographic Data		Excavation Results		
		Angle	Angular Distance	Length	Depth		Defect Length	Defect Type	Defect Length	Defect Depth	Defect Type
62	1	70°	1.1	Full Length	0.4	-12	Full Length	Large Porosity	Full	0.4	Large Porosity
64	3/4	70°	0.9	1.6	0.3	-11	1.6	Large Slag Line	1.6	0.3	Large Slag Line

* The lower the defect rating the more severe the defect.

