

TECHNICAL REPORT STANDARD PAGE

1. Report No. FHWA/LA-92/287		2. Government Accession No.	3. Recipient's Catalog No.
4. Title and Subtitle Break and Seat of Jointed Reinforced Concrete Pavements		5. Report Date September 1994	
		6. Performing Organization Code	
7. Author(s) William M. King, Jr., P.E.		8. Performing Organization Report No. 287	
9. Performing Organization Name and Address Louisiana Transportation Research Center 4101 Gourrier Avenue Baton Rouge, LA 70808		10. Work Unit No.	
		11. Contract or Grant No. DTFH71-91-SP202-LA-10	
12. Sponsoring Agency Name and Address La. Department of Transportation and Development P.O. Box 94245 Baton Rouge, LA 70804-9245		13. Type of Report and Period Covered Construction Report May 91 - March 92	
		14. Sponsoring Agency Code	
15. Supplementary Notes Conducted in cooperation with the U.S. Department of Transportation, Federal Highway Administration.			
16. Abstract <p>The purpose of this research is to evaluate the effectiveness of break, seat and overlay strategies for the retardation of reflective cracking in bituminous concrete overlays over PCC pavements. This is a part of FHWA's special projects SP-202 in which Ohio, West Virginia and Kentucky are also participating.</p> <p>This report documents construction strategies and techniques, instrumentation installation, and data acquisition during pre-construction, construction and post construction. This is the first (construction) report of this five year research project.</p> <p>The experimental sections are located on I-20 near Minden, La. The core SP-202 experimental features included sections with a break pattern of existing PCC pavement of 6", 18" and 30" with a HMAC overlay, and a control section (no breaking) with a HMAC overlay only. Several other strategies included with this research were two sections of a large stone crack relief layer over the PCC pavement and HMAC overlay, sawing and sealing of the HMAC overlay at transverse joints, and sawing the slab panels every eight feet, seating and HMAC overlay.</p> <p>The overall construction of the roadway was a success, however, the first installation of instrumentation failed as a result of structural failure in the access utility boxes. New, stronger boxes were fabricated and the instrumentation reinstalled approximately 9 months after completing the construction of the experimental sections.</p>			
17. Key Words break and seat overlay, JRCP rehabilitation, large stone crack relief		18. Distribution Statement Unrestricted. This document is available through the National Technical Information Service, Springfield, VA 21161.	
19. Security Classif. (of this report) Unclassified	20. Security Classif. (of this page) Unclassified	21. No. of Pages 56	22. Price

BREAK AND SEAT OF JOINTED
REINFORCED CONCRETE PAVEMENTS

INTERIM CONSTRUCTION REPORT
BY

WILLIAM M. KING, JR., P.E.
RESEARCH ENGINEER SUPERVISOR

RESEARCH REPORT NO. 287

SPECIAL PROJECT NO. 202

STATE PROJECT NO. DTFH71-91-SP202-LA-10

Conducted by
LOUISIANA TRANSPORTATION RESEARCH CENTER,
LOUISIANA DEPARTMENT OF TRANSPORTATION AND DEVELOPMENT
In Cooperation With
U.S. DEPARTMENT OF TRANSPORTATION
FEDERAL HIGHWAY ADMINISTRATION

The contents of this report reflect the views of the authors who are responsible for the facts and the accuracy of the data presented herein. The contents do not necessarily reflect the official views or policies of the State or Federal Highway Administration. This report does not constitute a standard, specification, or regulation. The Louisiana Department of Transportation and Development and the Louisiana Transportation Research Center do not endorse products, equipment or manufacturers.

June 1994

ABSTRACT

The purpose of this research is to evaluate the effectiveness of break, seat and overlay strategies for the retardation of reflective cracking in bituminous concrete overlays over PCC pavements. This is a part of FHWA's special projects SP-202 in which Ohio, West Virginia and Kentucky are also participating.

This report documents construction strategies and techniques, instrumentation installation, and data acquisition during pre-construction, construction and post construction. This is the first (construction) report of this five year research project.

The experimental sections are located on I-20 near Minden, La. The core SP-202 experimental features included sections with a break pattern of existing PCC pavement of 6", 18" and 30" with a HMAC overlay, and a control section (no breaking) with a HMAC overlay only. Several other strategies included with this research were two sections of a large stone crack relief layer over the PCC pavement and HMAC overlay, sawing and sealing of the HMAC overlay at transverse joints, and sawing the slab panels every eight feet, seating and HMAC overlay.

The overall construction of the roadway was a success, however, the first installation of instrumentation failed as a result of structural failure in the access utility boxes. New, stronger boxes were fabricated and the instrumentation reinstalled approximately 9 months after completing the construction of the experimental sections.

Table of Contents

Abstract	iii
Table of Contents	v
List of Tables	vii
List of Figures	ix
1. Introduction	1
2. Objective	3
3. Scope	3
4. Section Description and Location	5
5. Pre-construction Activities	9
5.1 Pre-rehabilitation Distress Survey	9
5.2 Edge Drain Installation	9
5.3 Instrumentation Location Determination	9
5.4 Pavement Deflection Testing	11
5.5 PCC Thickness Verification Coring	12
6. Construction Phase	15
6.1 Pavement Breaking and Seating Operations	15
6.2 Post Break PCC Cores	17
6.3 Post Break Pavement Deflection Testing	18
6.4 HMAC Overlay	19
7. Instrumentation Installation	21
7.1 General	21
7.2 Installation Procedures	23
7.3 Reinstallation	24
8. Post Overlay Testing and Monitoring	27
8.1 Post Overlay FWD Testing	27
8.2 AC Coring	27
8.3 Displacement Readings	28
9. Summary and Conclusions	33
Appendix A	35
Appendix B	49

List of Tables

1. Louisiana SP-202 Test Section Layout	7
2. Louisiana Supplemental Test Sections	8
3. Louisiana Supplemental Test Sections	8
4. Pre-break Joint Movement	11
5. Pre-break 4" Diameter PCC Cores	13
6. Pavement Breaking Effort and Sequence	17
7. Post Break, 6" Cores, Within the Test Sections	19
8. Louisiana Overlay Dates and Plan Thickness	20
9. Recommended Job Mix Formulas	20
10. Joint/Crack Monitoring Gauge Installation Locations	22
11. AC Core Location and Thickness	28
12. AC Modulus	28
13. Average Initial Gauge Readings	30
14. Louisiana I-20 Pre-break Joint Movement	51

List of Figures

1. Typical Cross Section	6
2. Crack Width of Existing Joint	10
3. Condition of Slab Edge at the Joint	10
4. Falling Weight Deflectometer (FWD, Deflection Testing)	12
5. Walker 6.5 Ton Breaker	16
6. 50 Ton Roller	16
7. After Break Core, 6" Break Pattern	18
8. Monitoring Gauge Assembly	21
9. Saw Cut for Utility Box Installation	25
10. Installation of Monitoring Gauge	25
11. Preparing Base for Utility Box	26
12. Installation of Utility Box	26
13. La. Initial Distress Survey and Gauge Location	26

1.0 INTRODUCTION

This research project is part of the FHWA sponsored Special Project 202, Break and Seat of Jointed Reinforced Concrete Pavement (SP-202). Under SP-202 similar research projects are being conducted in West Virginia, Ohio, and Kentucky.

The Louisiana Department of Transportation and Development (LADOTD) as well as other transportation agencies have for many years investigated numerous methods of preventing reflective cracking in Hot Mix Asphaltic Concrete (HMAC) overlays. By participating in the SP-202 research, Louisiana will not only benefit from the direct research results from its project, but will also benefit from the results of the companion research projects constructed by the other SP-202 participating states.

The SP-202 project in each state will be constructed under the experimental design defined in the FHWA Document Special Project 202 Technical Resource Forum June 6 & 7, 1989. The primary difference between projects constructed in each State will be the thickness of the asphalt concrete (AC) overlay. In addition, environmental factors and traffic loadings may vary.

In Louisiana, the overall rehabilitation project incorporated the break and seat technique using a 24 inch break pattern of the existing pavement. The broken pavement then received a HMAC overlay of variable thickness necessary to provide cross slope enhancements. To maintain the adjustments to the cross slope, the SP-202 control and test sections were also designed for a transversely variable HMAC overlay thickness.

The overlay thickness on the overall rehabilitation project varied from 9.5 inches at the outside shoulder to 12.5 inches at the inside shoulder. The SP-202 overlay thickness was reduced 2.5 inches from this thickness to bring anticipated pavement performance more closely in line with the five year monitoring period. As a result, SP-202 test sections incorporated a 7-10 inch transversely variable HMAC overlay. Actual in-place overlay thickness, determined from AC cores, are included in Table 11.

In addition to the SP-202 sections, Louisiana also incorporated several "supplemental," sections in order to directly evaluate the performance of the break and seat technology with other rehabilitation strategies. The supplemental sections were also overlaid with a 7-10 inch transversely variable HMAC thickness to be consistent with the SP-202 sections.

Pictorial presentations of many of the activities associated with this project are included throughout the report. They address pavement breaking operations, drilling and coring, deflection testing, and installation of joint/crack monitoring equipment respectively. Video tape recordings were also made to visually document many of the project phases and these video recordings are part of the project file.

2.0 OBJECTIVE

The objective of this research is to evaluate the effectiveness of Break and Seat rehabilitation strategies for the retardation of reflective cracking in bituminous concrete overlays over portland cement concrete pavements.

3.0 SCOPE

The scope was limited to seven test sections and one control section incorporated with a single break, seat and overlay project. Each of these experimental sections was divided into approximately equal lengths constructed on the eastbound roadway within the first phase of the construction project of approximately three miles. A general description of the experimental features including the supplemental sections to the existing pavement are as follows: 1) constructing a crack relief HMAC base layer placed over existing pavement, 2) constructing a crack relief HMAC base layer placed over the existing pavement with saw cuts at the third points of the existing slab, 2) sawing and sealing the HMAC overlay at the existing transverse joints, 4) a 6" break pattern, seating and HMAC overlay of the existing pavement, 5) an 18" break pattern, seating and HMAC overlay of the existing pavement, 6) a 30" break pattern, seating and HMAC overlay of the existing pavement, 7) sawing every 8', seating and HMAC overlay of the existing pavement. The control section consisted of HMAC overlay over the existing pavement.

4.0 SECTION DESCRIPTION AND LOCATION

The Louisiana SP-202 and supplemental test sections were constructed during the fall of 1991 as part of a larger, 11 mile rehabilitation project on Interstate 20. The project is located in the vicinity of milepost 43 through 54, east of Minden, in Webster and Bienville Parishes. Although the overall rehabilitation project involved both the east and westbound lanes, all test sections were constructed in the eastbound lanes. The experimental sections were constructed across both the passing (inside) and the travel (outside) lanes, however, the monitoring component of this research effort concentrates on the performance of the travel lane.

The existing pavement in this section is a jointed, 10 inch thick, doweled, wire mesh reinforced, portland cement concrete (PCC) on four inches of cement treated base (CTB) constructed in 1959. Figure 1 shows the typical cross section used on this project. The joint spacing is 58 1/2' and many slabs in the travel lane have either third point or quarter and midpoint cracks. Many joints were deteriorated and had asphaltic concrete (AC) patches. The remaining joints have very large joint openings, ranging from 1 to 3 inches. Figure 13 of Appendix A is a distress survey of the SP-202 test sections prior to construction.

The SP-202 test sections are 1000 feet long, except for the control section which is only 662 feet because of it being constructed near the end of the construction project. The four supplemental sections range from 1,000 to 1,122 feet long.

The SP-202 test sections were constructed with a 7-10 inch transverse variable thick HMAC overlay on an unbroken control section and on sections that were broken into 6, 18 and 30 inch patterns of the existing PCC pavement. The specific station locations of each section along with actual break patterns constructed are shown in Table 1. The four supplemental sections are described in Tables 2 and 3.

The current average daily traffic count is 24,300 vehicles per day (vpd) with 36 percent truck traffic. A ten year projection of 34,450 vpd was used for the HMAC overlay design. This traffic produces an estimated 4,070 Equivalent Single Axle Loadings (ESALS) per day or 7.5 million ESALS for this five year study.

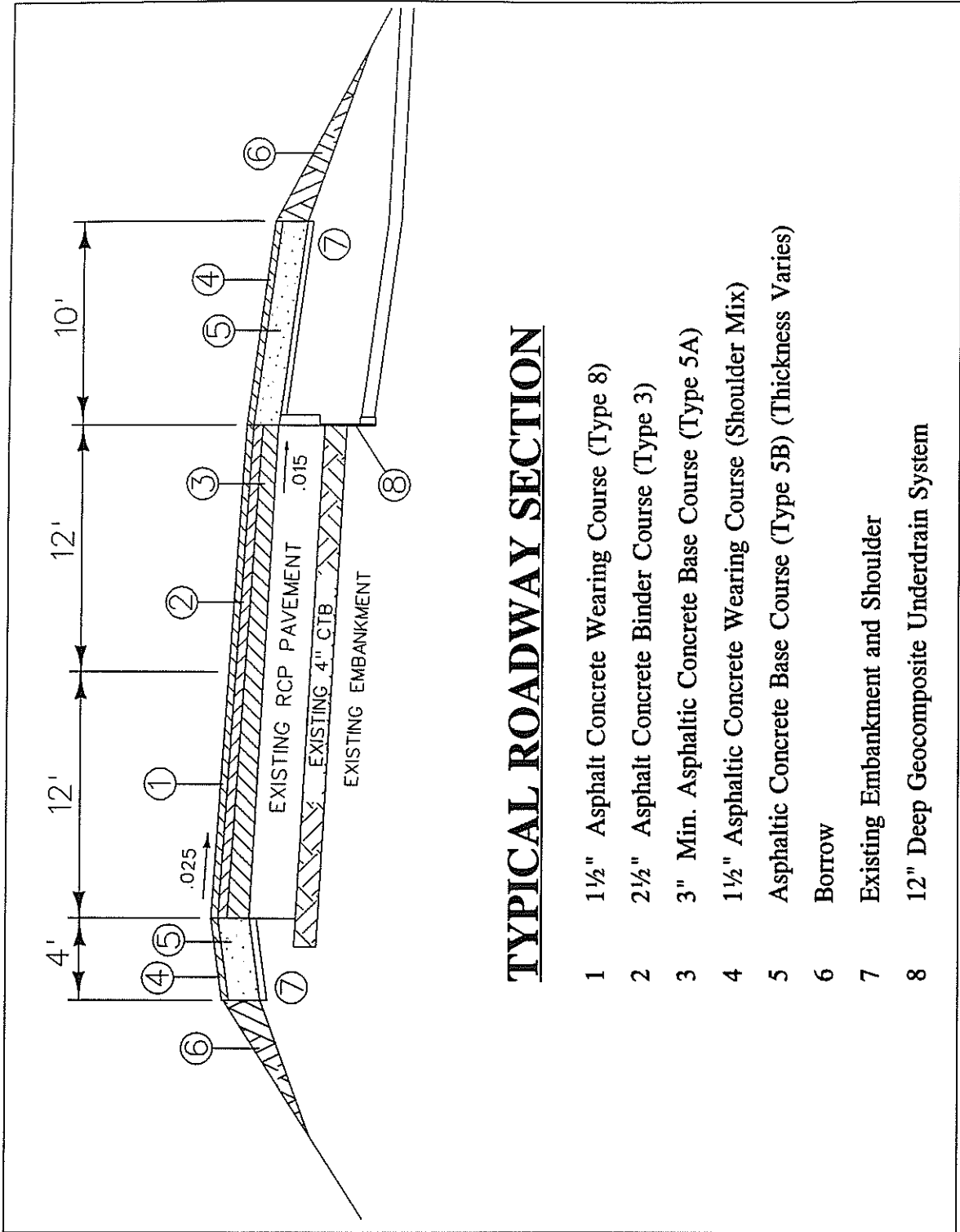
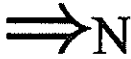

Figure 1. Typical Cross Section

TABLE 1

Louisiana SP-202 Test Section Layout

	Travel Lane	Passing Lane
915+66	Supplemental Section #1	
926+78	Supplemental Section #2	
938+00	Supplemental Section #3	
948+00	Transition	Transition
949+00	SP-202 Section #1	6"
959+00	Transition	Transition
960+50	SP-202 Section #2	18"
972+00	Transition	Transition
982+00	SP-202 Section #3	30"
992+00	Supplemental Section #4	
1018+60	Transition	Transition
1025+22	SP-202 Section #4	Control



EASTBOUND TRAFFIC



TABLE 2
Louisiana Supplemental Test Sections

	Travel Lane	Passing Lane
915+66	Supplemental Section #1	
926+78	Supplemental Section #2	
938+00	Supplemental Section #3	
948+00	Transition	Transition
982+00	Supplemental Section #4	
992+00		

TABLE 3
Louisiana Supplemental Test Sections

Section No.	Station	Preparation	Overlay
Supplemental #1	915+66 926+78 (1112')	None	7-10" HMAC Overlay; Including 3.5" Large Stone Mix Interlayer
Supplemental #2	926+78 938+00 (1122')	JRCF Steel Sawed @ 3rd Points	7-10" HMAC Overlay; Including 3.5" Large Stone Mix Interlayer
Supplemental #3	938+00 948+00 (1000')	Full Depth PCC Joint Replacement	Conventional 7-10" Transversely Variable HMAC with Saw & Seal
Supplemental #4	982+00 992+00 (1000')	JRCF Steel Sawed @ 8 ft. Intervals	Conventional 7-10" Transversely Variable HMAC

5.0 PRE-CONSTRUCTION ACTIVITIES

5.1 Pre-rehabilitation Distress Surveys

An initial visual distress survey was conducted on the SP-202 sections prior to breaking operations. Crack positions were measured and a crack map produced. In addition, a hand held videotape recording of each section was taken to permanently record the pre-rehabilitation distress for future reference. The initial distress survey for the SP-202 test sections is shown in Figure 13 of Appendix A. Figures 2 and 3 are sample photographs of the existing joint conditions.

5.2 Edge Drain Installation

Contract specifications for this project required the contractor to remove the existing edge drain and install a new geocomposite longitudinal edge drain with 500 foot maximum outlet spacing.

5.3 Instrumentation Location Determinations

The SP-202 experimental design specifies instrumenting test section joints and/or cracks to monitor minimum and maximum crack/joint openings over various temperature ranges. These displacement gauges are affixed to the side of the underlying PCC pavement under the outside lane-shoulder joint after the AC overlay is placed. The instrumentation is protected by a specially designed metal frame box which allows access for reading the gauges.

In order to assure that only working joints/cracks were instrumented, pre-break joint/crack movement was monitored within the SP-202 control and test sections. Movement was monitored by measuring the distance between brass pins inserted in the PCC on each side of the test section joints. Analysis of data from readings taken at pavement temperatures of approximately 94° F and 71° F and is summarized in Table 4. Table 14 of Appendix B provides detailed data on pre-break joint/crack movement.

In addition, in order to assure that the side of the pre-break PCC slab would later support mounting the gauges, potential instrumentation locations were evaluated and selected when the side of the PCC slab was exposed during edge drain installation. Approximately 15 potential locations

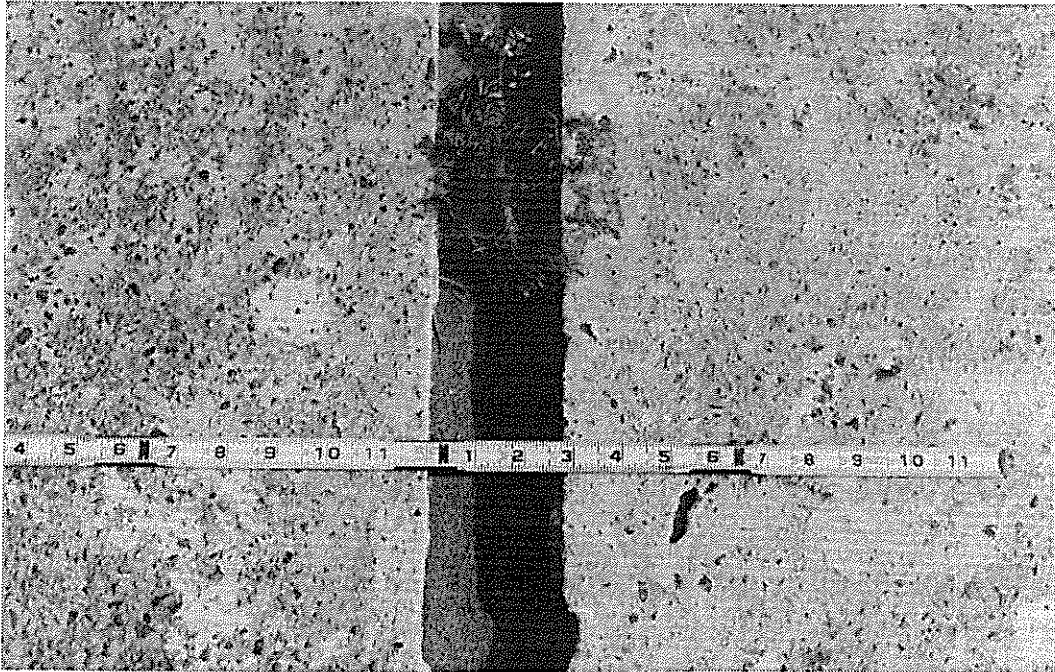

Figure 2. Crack width of existing joint.

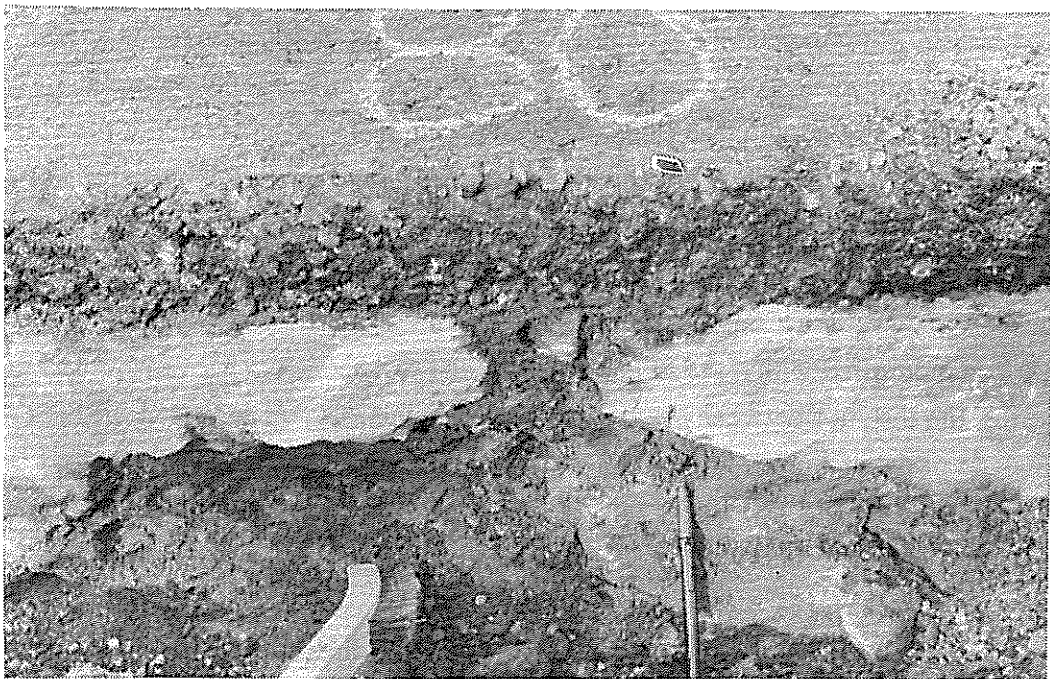

Figure 3. Condition of slab edge at the joint.

per section were identified and referenced to facilitate precise re-location after overlay.

TABLE 4

Pre-Break Joint Movement

Section Number	Average Joint Movement	No. Locked Joints
1	0.07	25%
2	0.25	10%
3	0.05	30%
4	0.13	5%

The exact location of instrumented joints/cracks are graphically depicted on the pre-construction distress survey is also shown in Figure 9 of Appendix A. This survey also displays the distance to the nearest crack/joint on either side of the instrumented crack/joint.

5.4 Pavement Deflection Testing

LTRC contracted with the Army Corps of Engineers at Vicksburg, Mississippi to conduct Falling Weight Deflectometer (FWD) deflection tests on the SP-202 and supplemental test sections. All FWD tests were conducted in the outside wheel path of the outside lane at loads corresponding to 9,000, 15,000, and 24,000 lbs. A Dynatest brand FWD was used as shown in Figure 4.

The Corps took initial FWD readings of the unbroken PCC slabs on September 17, 1991, just prior to breaking operations to minimize the effect of subgrade moisture variations on the before and after FWD readings. Pre-break tests were conducted at each mid-panel and on each side of all non AC patched joints which were designated as potential instrumentation locations. The FWD data collected will be analyzed to determine load transfer and joint efficiency and reported in the interim report.

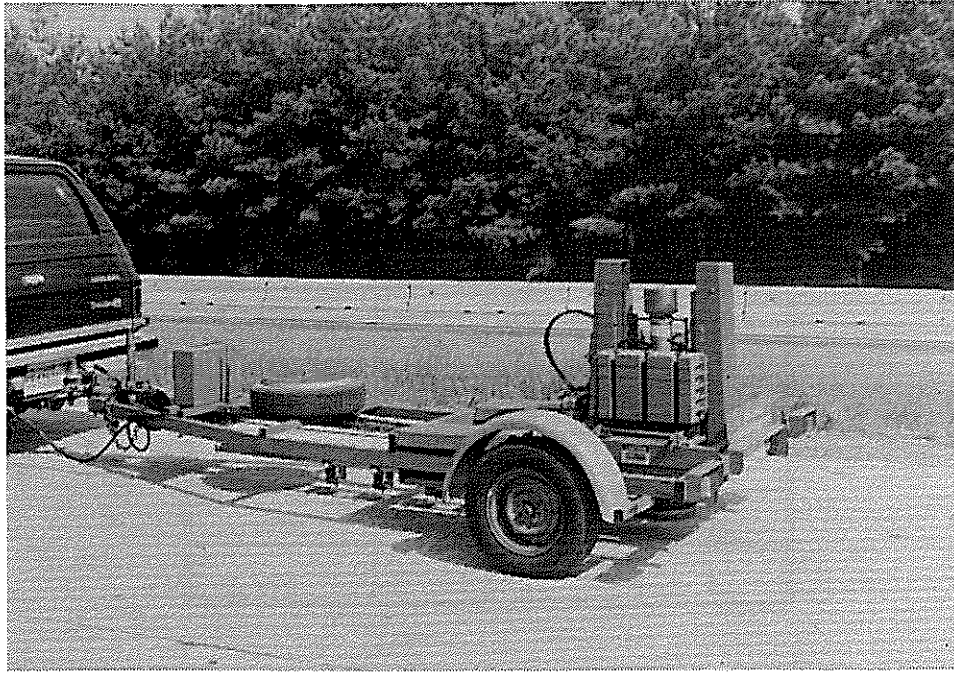

Figure 4. Falling Weight Deflectometer (FWD).

5.5 PCC Thickness Verification Coring

Two 4 inch cores were extracted from the travel lane of each test section prior to breaking operations to verify PCC thickness . These cores were taken to coincide with pre-breaking mid-panel FWD test points at the locations shown in Table 5.

The four inch cores were transferred to FHWA's Turner Fairbanks Highway Research Center to determine their thermal coefficient of expansion. Results of these tests will be reported in the interim report.

Table 5
Pre-break 4" Diameter PCC Cores

Section	Pattern	Station	Core #	Thickness	AVG
1	6"	951+75	B-3	9¼"	9⅝"
		957+00	B-2	10"	
2	18"	962+75	C-1	6½" 3⅛"	9½"
		968+50	C-2	9½"	
3	30"	974+00	D-1	9½"	9⅝"
		980+25	D-2	8⅝" 1¼"	
4	Control	1020+50	E-1	9" ¾"	9⅞"
		1023+50	E-2	10"	

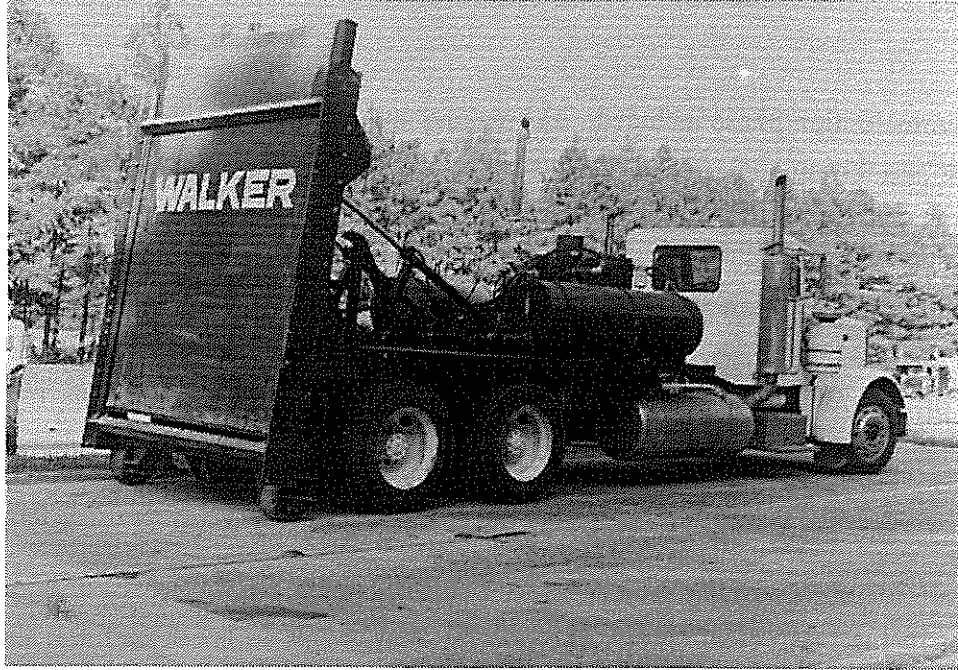

Figure 5. Walker 6.5 Ton Breaker.

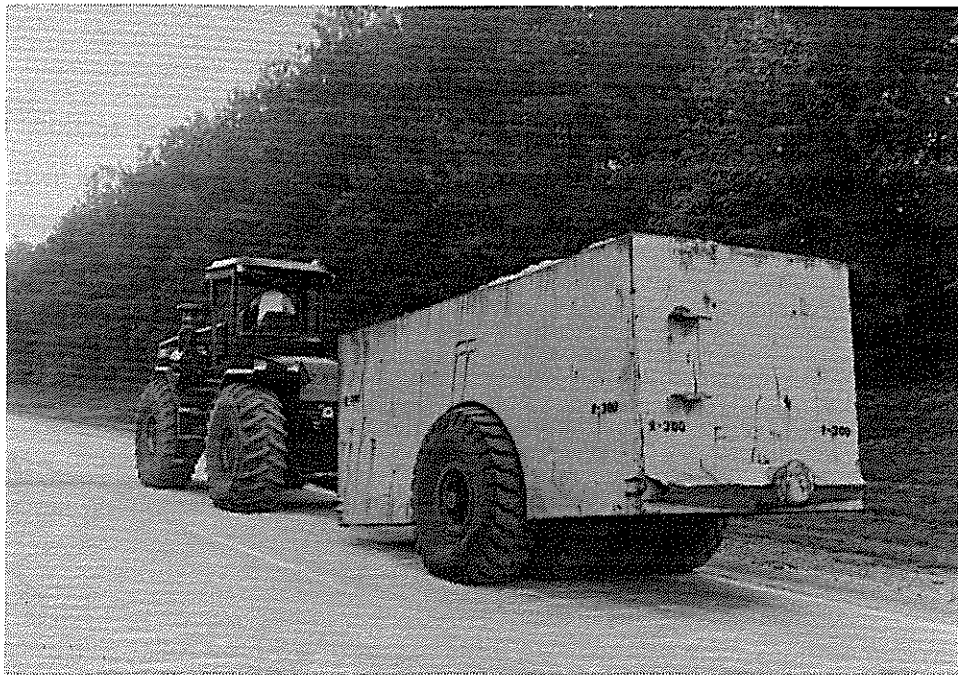

Figure 6. 50 Ton Roller.

breaking effort was evident by observing the recently placed sand slurry seal joint sealer being squeezed from the joint.

TABLE 6

Pavement Breaking Effort and Sequence

Section (Pattern)	Station	Lane	Height	Spread	No. Pass Per 24' Roadway	Pass Sequence		
						1st	2nd	3rd
1 (6") (Fill)	949+00	Slow	48"	8"	4	Outside	Middle	Center
	959+00	Fast						
2 (18") (Cut)	960+50	Slow	48"	12"	3	Outside	Center	Middle
	970+50	Fast						
3 (30") (Fill)	972+50	Slow	48"	27"	3	Outside	Center	Middle
	982+50	Fast						
4 (Control) (Fill)	1002+50	Slow	NA	NA	NA	NA		
	1012+50	Fast						

6.2 Post Break PCC Cores

LTRC also extracted six inch verification cores of the broken PCC pavement within each test section to monitor the effectiveness of the selected drop height, spacing and sequence. However, as a result of a drill rig mechanical failure, break verification cores were not taken for all test sections.

The six inch diameter cores taken within the test sections as shown in Figure 7 were to verify full depth breaks and determine the degree of debonding of the wire mesh reinforcing from the PCC. These cores were taken to coincide with selected post-break, mid-panel, FWD test locations. Information on these core locations are shown in Table 7.

Full-depth cracks were evident in each of the cores after breaking, however, in every case the steel was only partially debonded from the concrete. Coring operations and extracted cores were videotape recorded.



Figure 7. After Break Core, 6" Break Pattern.

6.3 Post Break Pavement Deflection Testing

The Army Corps of Engineers conducted additional FWD testing on each test section after breaking but before seating, and after seating. All tests were limited to mid-panel tests in the outside wheel path of the outside lane. These tests were taken using the same loads and sensor spacing employed in the pre-break FWD testing effort.

The FWD data collected will be analyzed and reported in a later report to back calculate the modulus of both the unbroken and the broken PCC under the AC overlay. The modulus test results are discussed in Section 8, "Post Overlay Testing and Monitoring." The FWD data collected is included on computer diskettes and are available in the project file.

TABLE 7

Post Break, 6" Core, Within the Test Sections

Section	Break Pattern	Station	Cored on Crack	Cracked Full Depth	Steel Debonded
1	6"	948+60	No	Yes	Very Little
		948+60	Yes	Yes	Partially
		950+00	Yes	Yes	Partially
		954+00	Yes	Yes	Mostly
		958+00	No	Yes	Partially
2	18"	No Further Cores - Core Drill Broke Down			
3	30"	No Further Cores - Core Drill Broke Down			

6.4 HMAC Overlay

The contractor paved the test sections as shown in Table 8. The SP-202 test sections were paved with a nominal 7-10 inch Hot Mix Asphaltic Concrete (HMAC) overlay as shown on the typical section in Figure 1. It includes a base, binder and wearing course which were placed in 12 foot wide passes. The mix design is provided in Table 9. HMAC overlay thickness verification cores were taken after overlay and are discussed in Section 8 of this report. The HMAC overlay was completed and accepted February, 1992.

TABLE 8

Louisiana Overlay Dates and Plan Thicknesses
(Outside Edge)

Section	Base Course		Binder Course		Wearing Course	
	Date	Thickness	Date	Thickness	Date	Thickness
1	10/24/91	3"	11/07/91	2½"	2/20/92	1½"
2	10/24/91	3"	11/07/91	2½"	2/20/92	1½"
3	10/24/91	3"	11/07/91	2½"	2/20/92	1½"
4	11/26/91	3"	12/15/91	2½"	2/20/92	1½"

TABLE 9

Recommended Job Mix Formulas

<u>U.S SIEVE SIZE</u> <u>PERCENT PASSING</u>	<u>WEARING</u> <u>COURSE</u>	<u>BINDER</u> <u>COURSE</u>	<u>BASE</u> <u>COURSE</u>
1 inch	100	100	99
3/4 inch	100	100	--
1/2 inch	100	97	--
3/8 inch	94	90	--
No. 4	65	58	62
No. 10	41	40	--
No. 40	26	26	26
No. 80	14	15	--
No. 200	8	7	8
% AC	5.0	5.0	5.2
% Crushed	94	97	84
Mix Temp, (°F)	328	320	322
Mix Time: (Rate, ton/hr)	250	250	250
<u>MARSHALL TEST PROPERTIES</u>			
Specific Gravity	2.36	2.36	2.34
Theoretical Gravity	2.43	2.44	2.44
Stability (lbs.)	1866	1704	1651
Flow (.01 in)	8	10	10
Air Voids (%)	2.9	3.4	4.2
VFA (%)	80.5	77.0	73.4

7.0 INSTRUMENTATION INSTALLATION

7.1 General

A diagram of the monitoring gauge assembly is shown in Figure 8. As the underlying PCC slabs expand and contract with thermal variations in slab temperature, the gauge remote arm pushes and pulls the pins from their original settings. By recording the original positions relative to a reference pin at the beginning of a monitoring period, the minimum, current and maximum joint opening over a monitoring period can be calculated.

A total of 40 mechanical crack monitoring gauges and supporting access boxes along with three bi-metal minimum/maximum thermometers were installed in late January, 1992 after the shoulder was paved to final grade. The exact location of each instrumented joint/crack was selected and referenced by a survey crew prior to overlay. Detailed information on specific installation locations are shown in Table 10 which are generally accurate to within approximately 1 foot. Figure 13 of Appendix A shows the location of the access boxes.

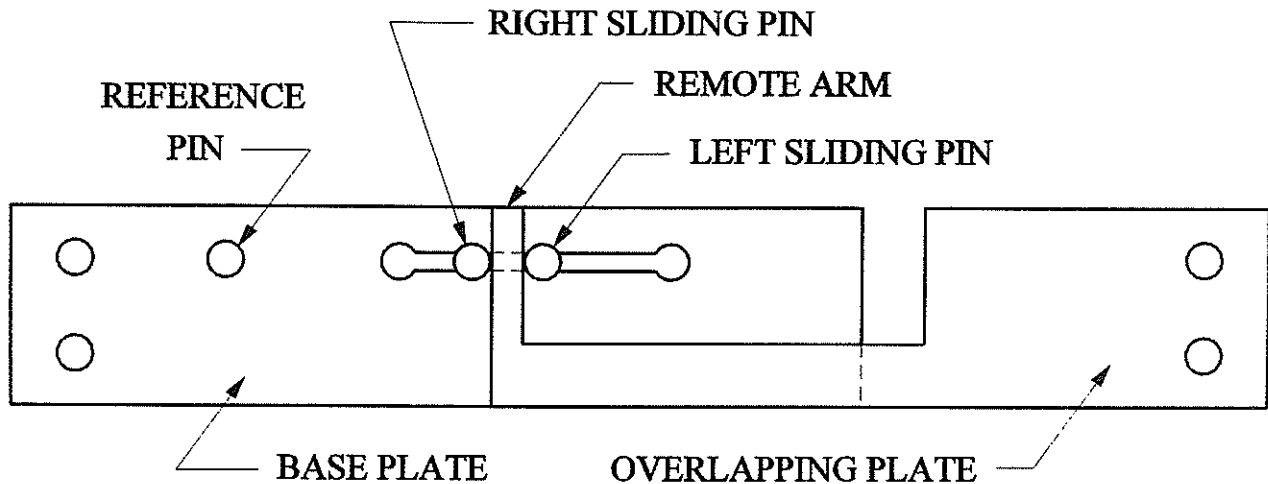

Figure 8. Monitoring Gauge Assembly.

TABLE 10

Joint/Crack Monitoring Gauge Installation Locations

Section	Box	Station	Crack or Joint	Temp. Gauge
1	1	948+43	Joint	-
	2	949+01	Joint	-
	3	950+77	Joint	Yes
	4	952+52	Joint	-
	5	953+69	Joint	-
	6	954+23	Joint	-
	7	954+86	Joint	-
	8	956+62	Joint	-
	9	956+86	Joint	-
2	1	960+13	Joint	-
	2	960+71	Joint	-
	3	961+88	Joint	Yes
	4	962+47	Joint	-
	5	963+64	Joint	-
	6	964+81	Joint	-
	7	965+93	Joint	-
	8	967+73	Joint	-
	9	969+49	Joint	-
3	1	973+00	Joint	-
	2	973+58	Joint	-
	3	975+92	Joint	Yes
	4	976+50	Joint	-
	5	977+68	Joint	-
	6	978+26	Joint	-
	7	980+02	Joint	-
	8	980+60	Joint	-
	9	981+19	Joint	-
	10	981+77	Joint	-

TABLE 10 (CONTD)

Joint/Crack Monitoring Gauge Installation Locations

Section	Box	Station	Crack or Joint	Temp. Gauge
4	1	1019+00	Joint	-
	2	1019+59	Joint	-
	3	1020+17	Joint	-
	4	1020+76	Joint	-
	5	1021+34	Joint	-
	6	1021+93	Joint	-
	7	1022+51	Joint	-
	8	1023+10	Joint	-
	9	1024+85	Joint	-
5	1	982+94	Joint	-
	2	983+00	Crack	-
	3	983+25	Crack	-

7.2 Installation Procedures

The contractor began excavation for the access boxes on January 29, 1992 and gauge installation was completed over the next three days as excavation progressed.

The monitoring sites were selected prior to overlay when the slab edge was exposed during edge drain installation. The exact location of each joints/crack to be instrumented were marked on the AC overlay at the shoulder joint using offset references established prior to overlay.

The contractor first saw cut the pavement and then excavated a 30 inch long, 14 inch wide, by 16 inch deep hole for each access box. The exact edge of the underlying PCC slab was located by using a two step saw cut operation. The first saw cut at the shoulder joint was deliberately offset about 2 inches into the shoulder. Once the access hole was partially excavated, the exact edge of the slab could be determined and a second, more exact, saw cut made. The pavement was removed using a jackhammer and hand tools.

Once the edge of slab was exposed, the displacement gauges were affixed with epoxy to the edge of the PCC slab. The contractor then used ready mix PCC to pour the access box base slab support. The access boxes were then set to grade and the area around the access boxes were back filled with additional PCC to within three inches of final shoulder grade. The contractor then used HMAC to fill in the remaining three inches.

To avoid build up of water and ice around the gauges, the PCC access box support base was removed along the side of the original PCC slab within the access box. Photographs of the installation process are shown in Figures 9, 10, 11, and 12.

7.3 Re-Installation

After the gauges were installed, the contractor established two directional traffic flow on the eastbound lanes. All eastbound main line traffic was partially channeled onto the outside shoulder. This new traffic pattern placed the access boxes, (which were only designed for shoulder use and to only support occasional partial wheel loads) in the outside wheel path of the main line pavement. Under this intense loading, the access boxes failed.

Safety and traffic maintenance on this high volume - high percent truck route dictated immediate repair. The only readily available repair that could be applied under traffic was to back fill the access boxes with asphalt concrete. This rendered the original gauges in-operable.

Once the contractor re-established directional flow of the traffic, the state redesigned and fabricated stronger access boxes. The new boxes along with new gauges were reinstalled at the same locations during the week of 10/28/92 through 10/30/92. The gauges were set and initial (start of monitoring period) readings were taken on 11/04/94 and 11/05/92 which are discussed in Section 8 of this report.

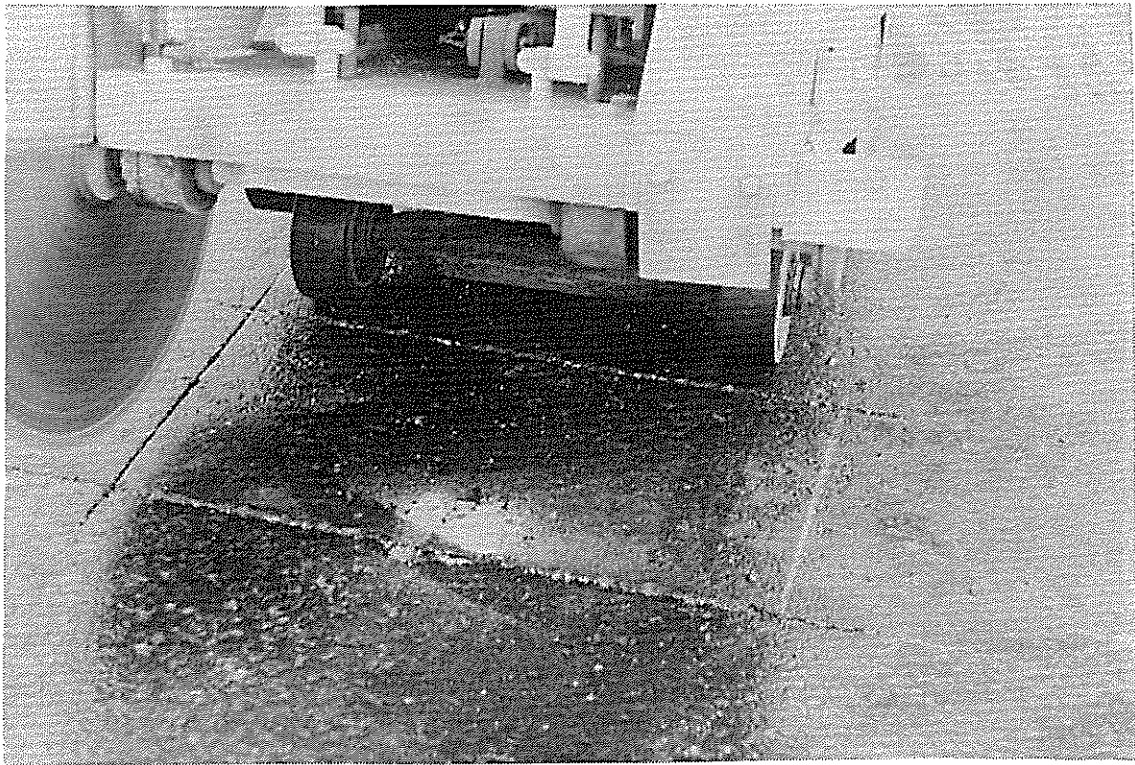

Figure 9. Saw Cut for Utility Box Installation.

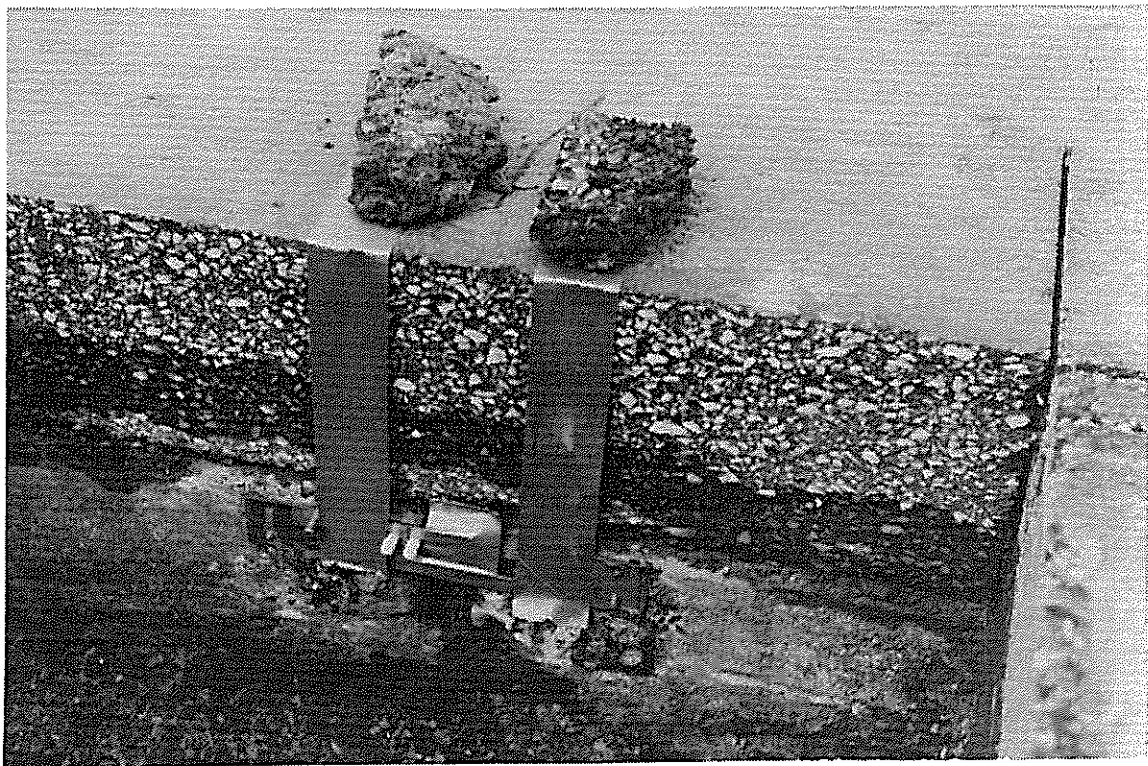

Figure 10. Installation of Monitoring Gauge.

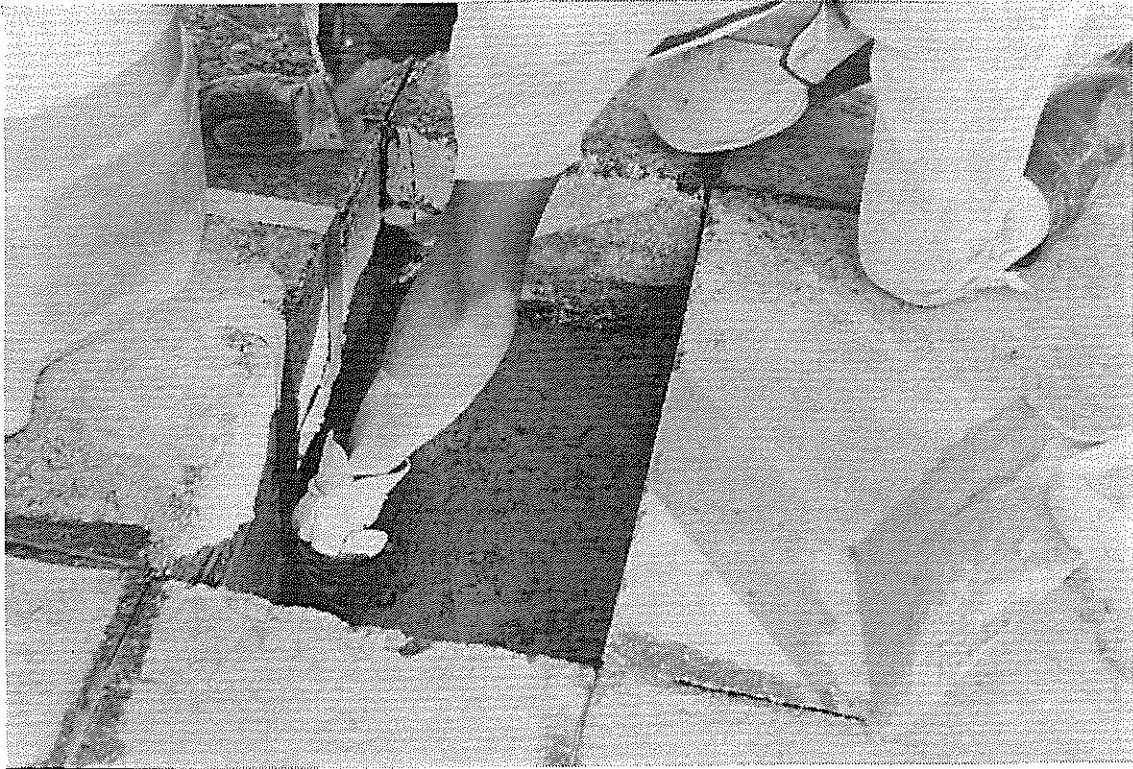

Figure 11. Preparing Base for Utility Box.

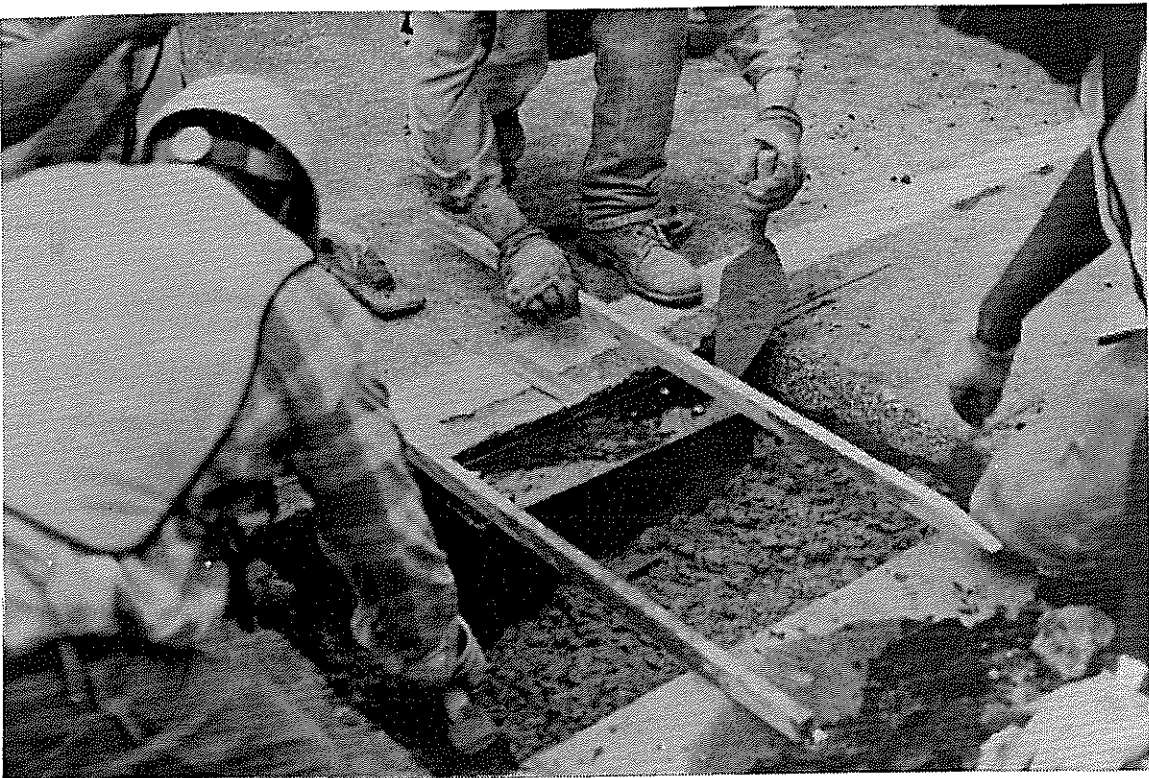

Figure 12. Installation of Utility Box..

8.0 POST OVERLAY TESTING AND MONITORING

8.1 Post Overlay FWD Testing

The Army Corps of Engineers conducted post-overlay FWD testing on the eastbound travel lane on January 30, 1992. The Corps conducted these test using the same number of FWD drops, drop heights and sensor spacing as previously used in the pre-overlay FWD testing. Tests were only conducted at the mid-panel of each slabs in the outside wheel path of the travel lane. To the extent possible, test locations coincided with pre-overlay mid-panel test locations. FWD data is contained on electronic diskettes and are available in the project file.

The FWD data analysis of the un-broken PCC cores will be included in the interim report. The raw FWD data are stored on electronic diskettes in the project file.

The SP-202 experimental design calls for additional FWD testing at the 1st, 3rd and 5th year anniversaries of the paving operation.

8.2 AC Coring

In place HMAC overlay thickness varied from the plans. HMAC thickness verification cores were taken in the outside wheel path of the outside lane. The samples were taken in each of the test sections to coincide with post break FWD mid-slab test locations. The HMAC cores were shipped to the FHWA Turner Fairbanks Highway Research Center (TFHRC) for Diametrol (indirect) resilient modulus testing. The thicknesses of the AC cores are shown in Table 11 and laboratory diametrol resilient modulus values are shown in Table 12.

TABLE 11

AC Core Location and Thickness
Outside Wheelpath, Travel Lane

Section	Station	Total Thickness
1 (6")	951+64	8.201
	957+03	8.129
2 (18")	962+77	8.475
	968+59	8.048
3 (30")	973+88	8.561
	980+27	8.236
4 (Control)	1020+46	8.340
	1023+51	7.757

TABLE 12

AC Modulus

Section	Temperature	Binder			Surface
		Bottom	Middle	Top	
Modulus (Average) (Kpsi)	41° F	1,132,000	1,464,000	1,884,000	1,465,000
	77° F	125,000	159,300	205,500	149,600
	104° F	28,900	33,400	41,000	29,000

8.3 Displacement Readings

The displacement and temperature gauges were originally set and recorded on February 4, 1992. As noted earlier, the initial installation failed prior to obtaining end of monitoring period readings, negating the data collected in February, 1992, at the original start of the monitoring period.

As discussed earlier in section 7, the new start of the monitoring period for the displacement gauge readings were taken on 11/04/92 and 11/05/92, using an electronic digital display caliper and recorded to the nearest 0.0005 inch. Multiple measurements of the width of the remote arm, the diameter of the left pin and the distance from the reference pin to the near and far pins were recorded and averaged. The multiple readings varied by less than 0.003 inch.

As a check on measurement accuracy, the direct measurement of the distance from the reference pin to the far pin was compared to the computed distance (determined by adding the width of the left moveable pin and the remote arm to the distance from the reference pin to the near moveable pin). The difference between the directly measured and computed distance ranged from -0.0030 inches (computed distance larger than direct measurement) to +0.0030 inches (computed distance smaller). The arithmetic mean was 0.0003 inches with a standard deviation of +0.0018 inches.

A similar analysis conducted on other SP-202 participating states' data resulted in similar standard deviations. It is quite evident that potential measurement errors will have negligible effect on the control section especially over large temperature ranges. The impact of potential measurement error increases significantly as the break pattern diminishes in size and the temperature range narrows.

Table 13 is a compilation of the average initial gauge readings. A copy of the raw data and computed average readings are included in the project file. The average readings represent the numbers that will be used to determine the minimum and maximum joint openings over the monitoring period that began on November 4, 1992.

The displacement gauge data have been structured for future analysis. The limited displacement data collected to date preclude any preliminary findings or conclusions on the relative performance of the test sections. Follow up displacement readings are scheduled for winter 1993. A visual distress survey, a video recording of pavement condition, and additional FWD readings will be taken at that time.

Table 13
Average Initial Gauge Readings
Date: 11/04/92 and 11/05/92

Sec. No.	Jt. No.	Remote Arm, in.	WIDTH, in.		CLOSED PINS, in.	
			Left Pin	Joint Assumed	Short Distance	Long Distance
1	59	.2562	.3098	1.0	1.9453	2.5412
	60	.2563	.3107	1.0	1.7568	2.3238
	63	.2587	.3130	1.0	1.7628	2.3330
	66	.2535	.3112	1.0	1.7207	2.2843
	68	.2550	.3085	1.0	1.6423	2.2092
	69	.2593	.3115	1.0	1.6188	2.1918
	70	.3022	.3118	1.0	1.6905	2.3068
	73	.2565	.3120	1.0	2.0342	2.6038
	74	Gauge not attached				
2	80	.2525	.3102	1.0	1.8498	2.4123
	81	.2552	.3128	1.0	1.7657	2.3310
	83	Gauge broke				
	84	.2582	.3120	1.0	2.0495	2.6220
	86	.2550	.3110	1.0	1.8390	2.4047
	88	.2530	.3100	1.0	1.9095	2.4730
	90	.2538	.3115	1.0	1.8132	2.3807
	93	.2540	.3107	1.0	1.7580	2.3247
	96	.2580	.3135	1.0	1.9410	2.5100
	No Box					

Table 13 (cont'd)
Average Initial Gauge Readings
Date: 11/04/92 and 11/05/92

Sec. No.	Jt. No.	Remote Arm, in.	WIDTH, in.		CLOSED PINS, in.	
			Left Pin	Joint Assumed	Short Distance	Long Distance
3	103	.2595	.3130	1.0	1.7570	2.3265
	104	.2530	.3120	1.0	1.7505	2.3135
	108	.2505	.3142	1.0	1.6477	2.2125
	109	.2515	.3123	1.0	1.6945	2.2607
	111	.2353	.3093	1.0	1.8807	2.4247
	112	.2567	.3117	1.0	1.9745	2.5448
	115	.2348	.3108	1.0	1.8798	2.4255
	116	.2535	.3128	1.0	1.7992	2.3650
	117	.2568	.3127	1.0	1.7957	2.3670
	118	.2458	.3113	1.0	1.8578	2.4152
4	C1	.2587	.3127	1.0	1.9157	2.4860
	C2	.2307	.3113	1.0	1.8448	2.3848
	C3	Gauge broke				
	C4	.2507	.3118	1.0	1.9023	2.4643
	C5	.2287	.3172	1.0	Box too narrow	
	C6	.2503	.3108	1.0	1.6738	2.2353
	C7	.2533	.3130	1.0	1.8337	2.4025
	C8	.2537	.3098	1.0	1.8510	2.4173
	C12	.2512	.3105	1.0	1.6785	2.2417

9.0 SUMMARY AND CONCLUSIONS

The SP-202 experimental features were successfully incorporated in this project through the assistance and dedication of many individual and organizational units through the Department. Each test section was constructed satisfactorily to their intended design. Although the original access boxes failed, the new stronger boxes should be adequate to protecting the gauges. Also, this will allow for the proper data acquisition of the gauges.

Initially, information will be limited because of the extended data collection periods and the nature of the research. This research is based on a function of time and temperature to determine it's success. It will determine the effectiveness of the breaking and seating effort of the various break patterns. It will determine which patterns are best in destroying the slab action of the underlying JRCF and reducing the reflective cracking in the asphalt concrete overlay.

SECTION 1
Sht. 2 of 3

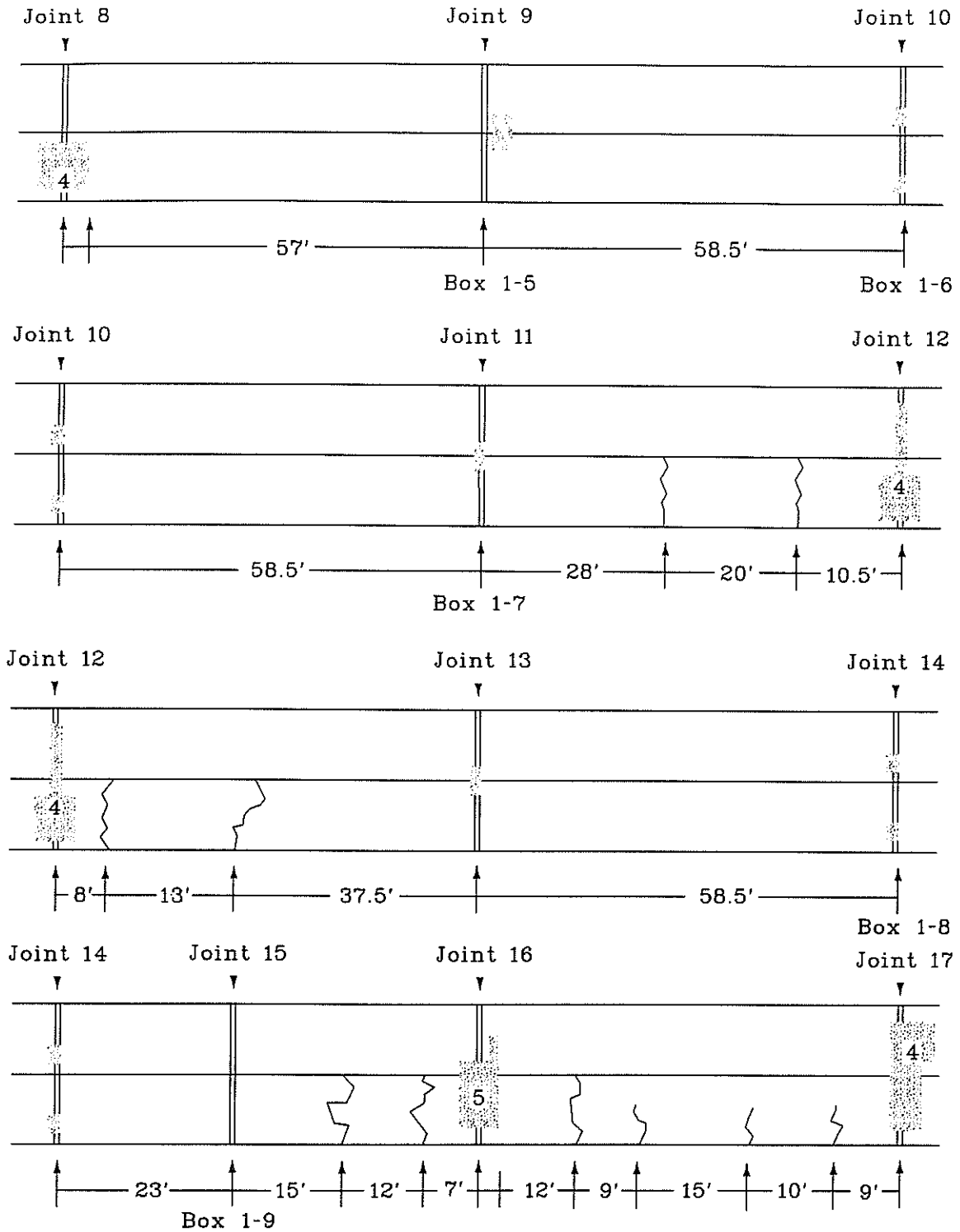

Figure 13 (Cont'd). La. Initial Distress Survey and Gauge Location.

SECTION 1
Sht. 3 of 3

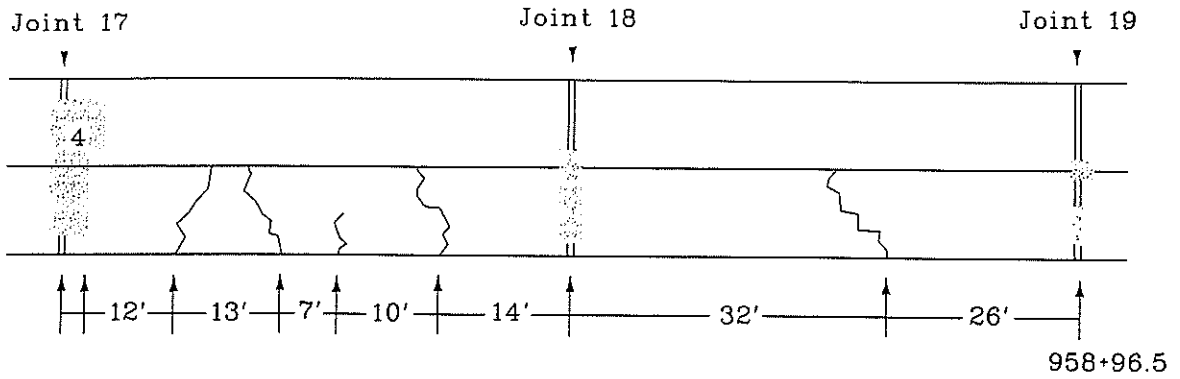

Figure 13 (Cont'd). La. Initial Distress Survey and Gauge Location.

SECTION 2
Sht. 1 of 3

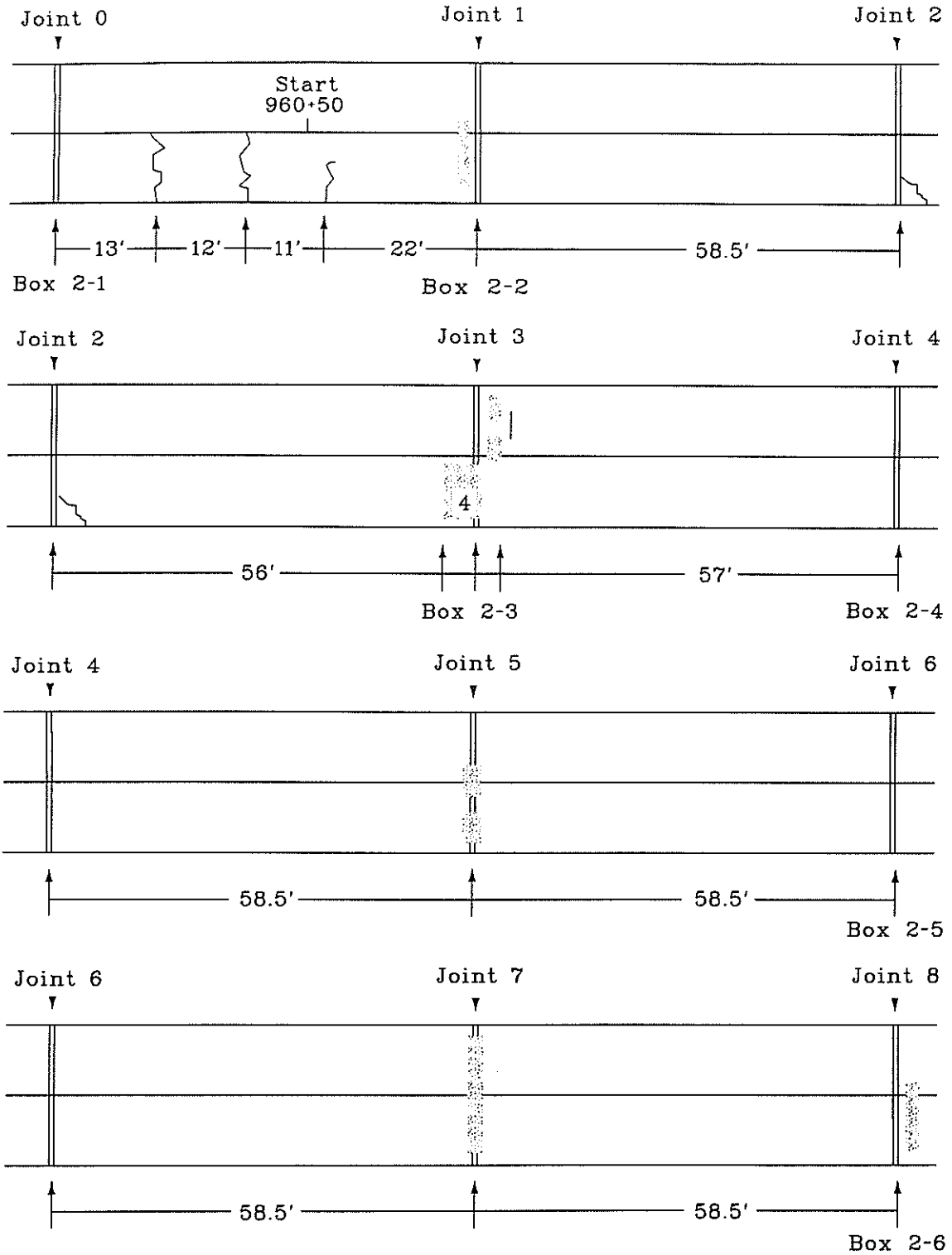

Figure 13 (Cont'd). La. Initial Distress Survey and Gauge Location.

SECTION 1
Sht. 2 of 3

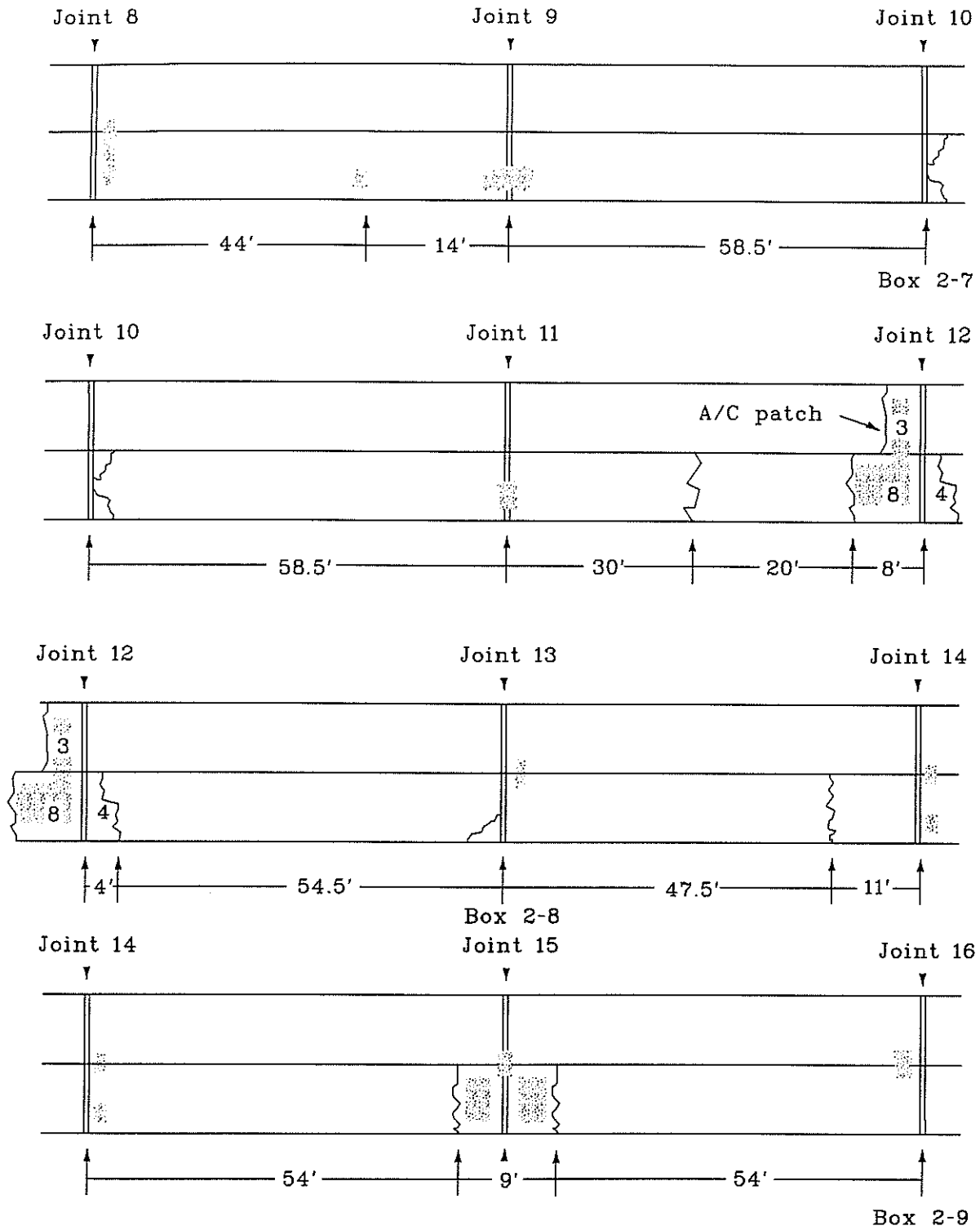

Figure 13 (Cont'd). La. Initial Distress Survey and Gauge Location.

SECTION 1
Sht. 3 of 3

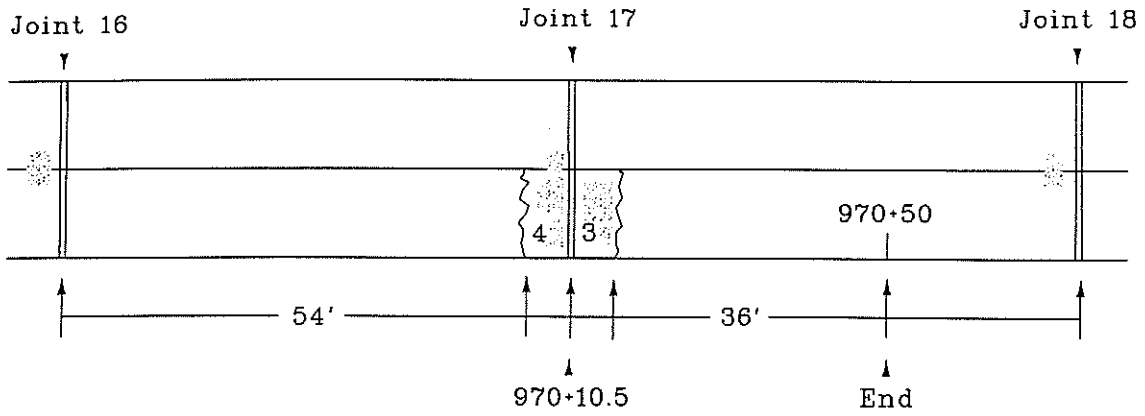

Figure 13 (Cont'd). La. Initial Distress Survey and Gauge Location.

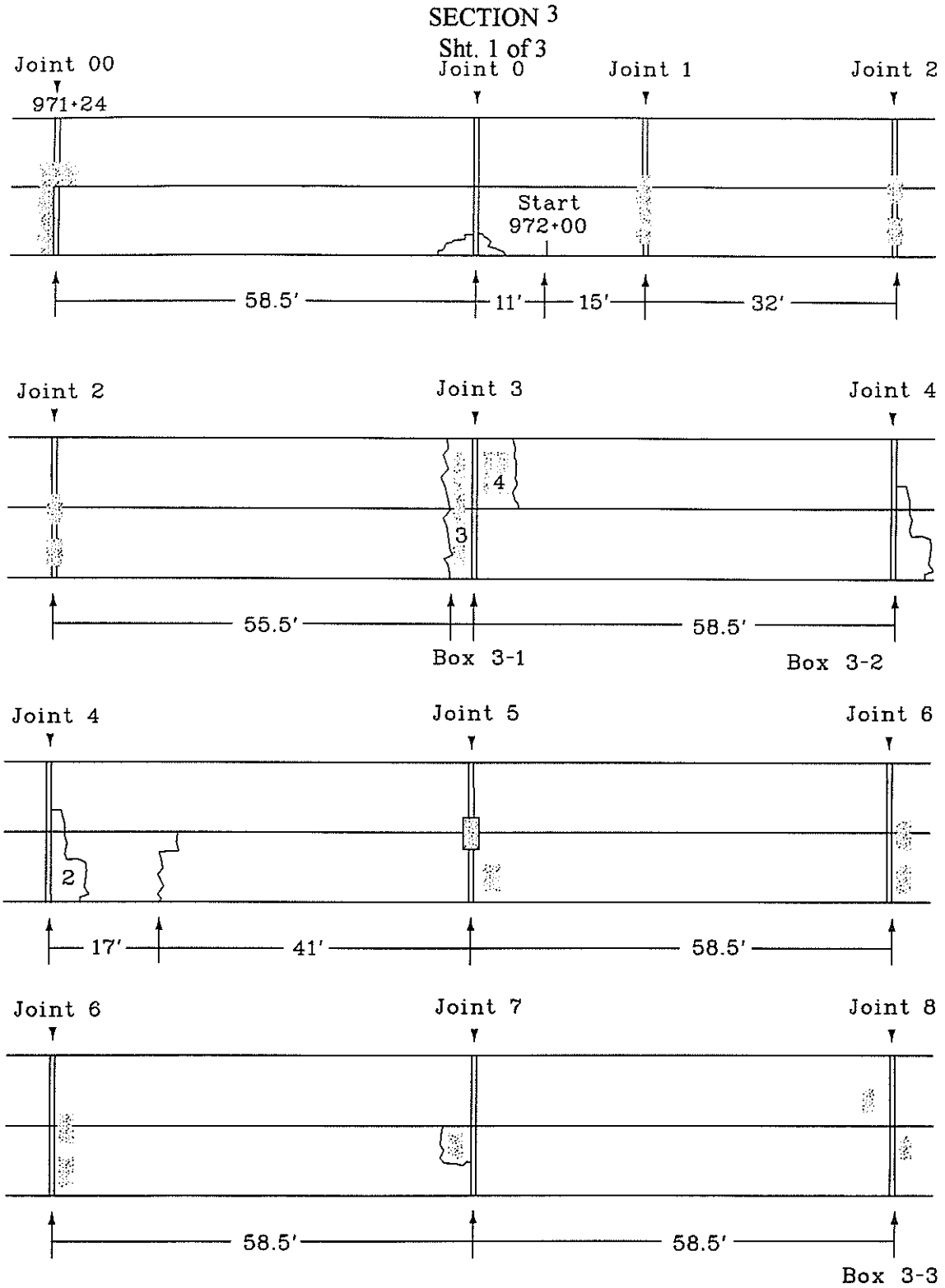

Figure 13 (Cont'd). La. Initial Distress Survey and Gauge Location.

SECTION 3
Sht. 2 of 3

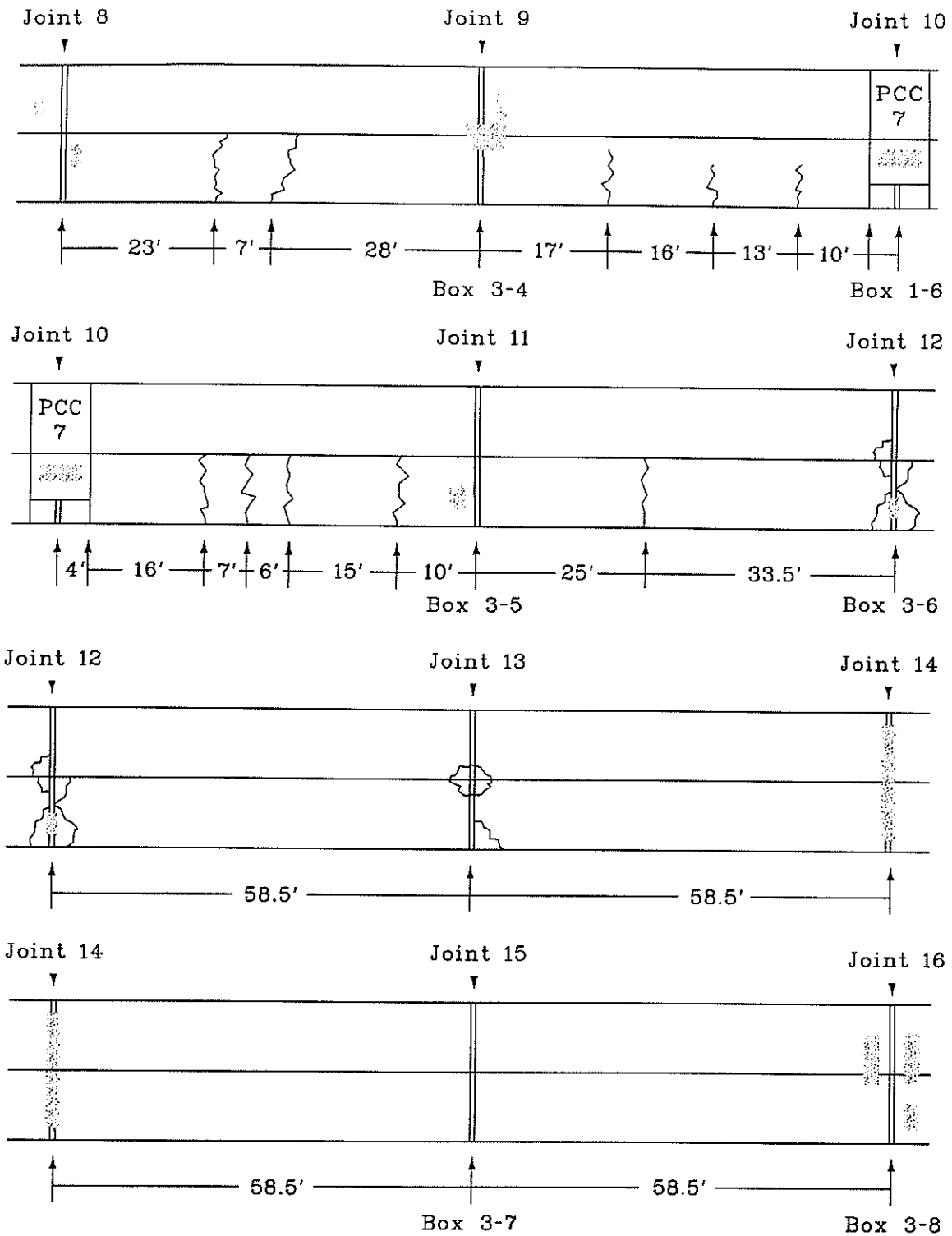

Figure 13 (Cont'd). La. Initial Distress Survey and Gauge Location.

SECTION 3
Sht. 3 of 3

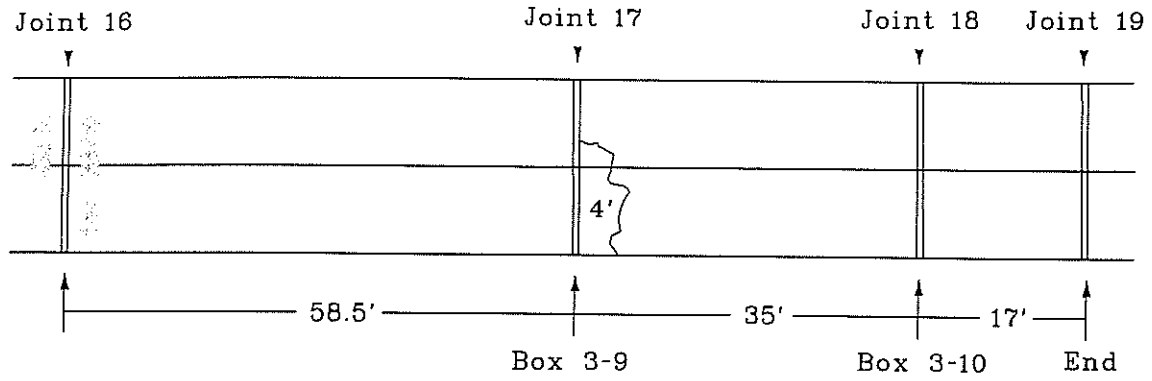

Figure 13 (Cont'd). La. Initial Distress Survey and Gauge Location.

SECTION 4

Sht. 1 of 2

Joint 1

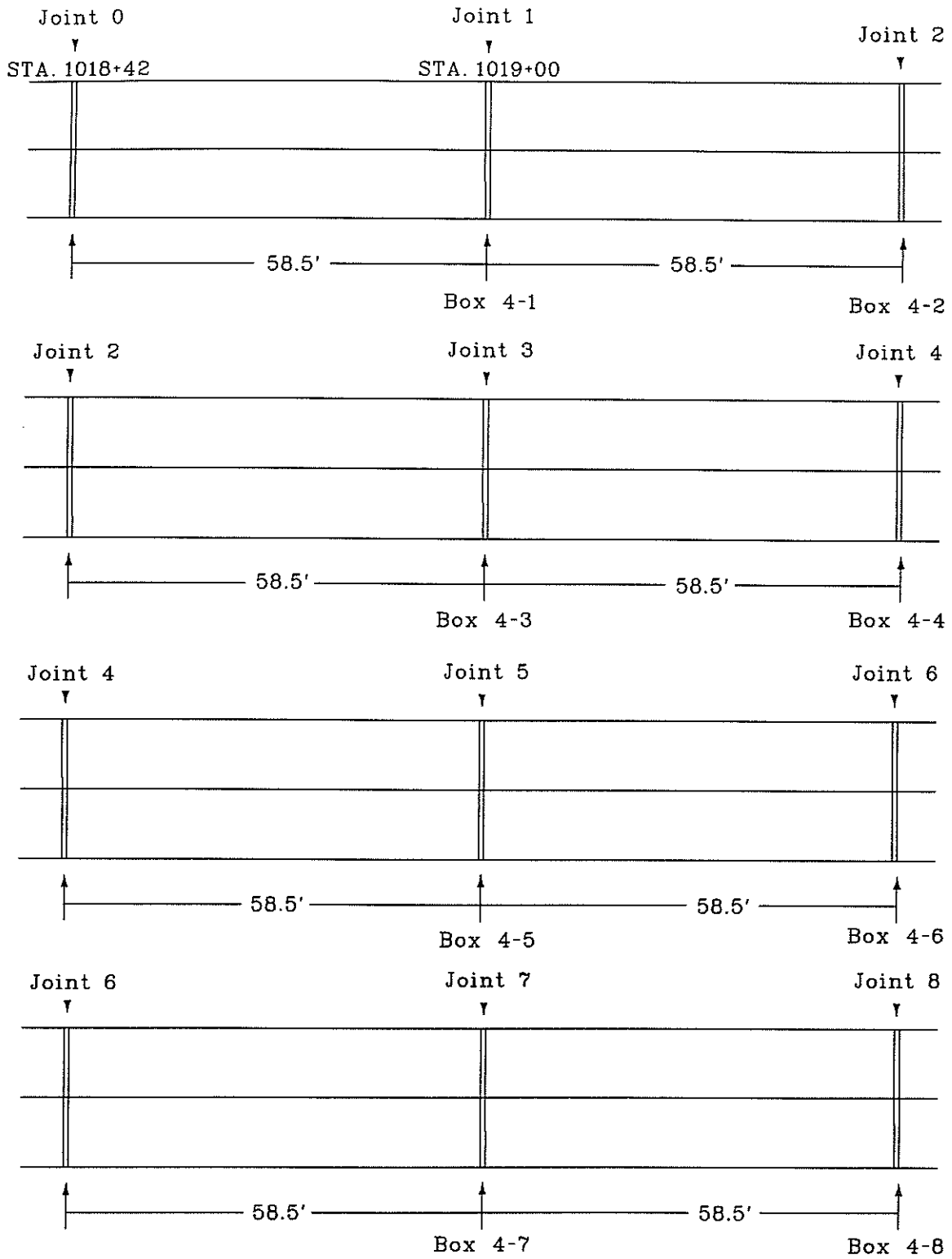

Figure 13 (Cont'd). La. Initial Distress Survey and Gauge Location.

SECTION 4
Sht. 2 of 2

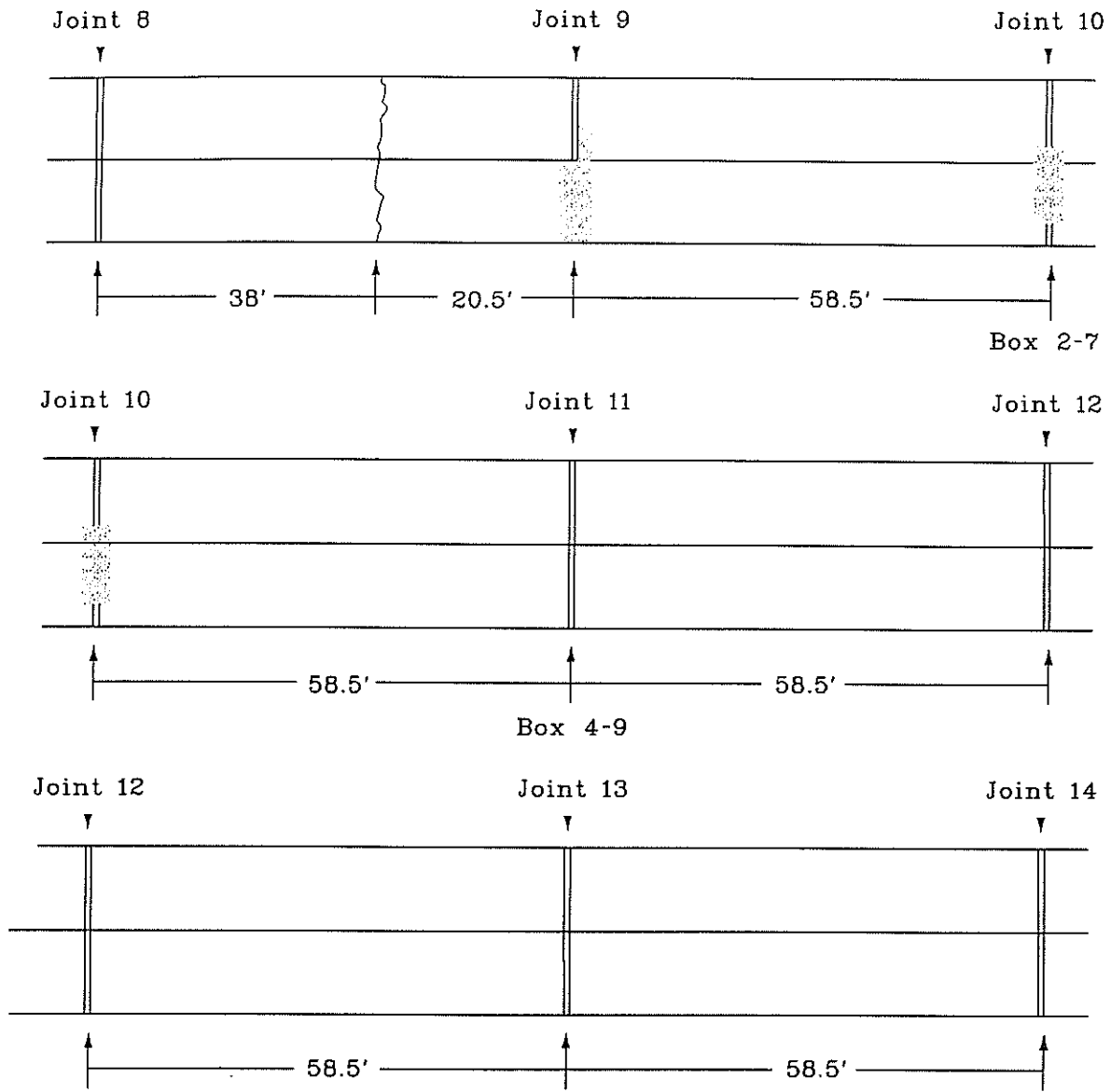

Figure 13 (Cont'd). La. Initial Distress Survey and Gauge Location.

TABLE 14

Louisiana I-20 Pre-break Joint Movement

Date of Readings: 9/06/89

Begin Log Mile at Milepost 53

	Section	Joint No.	Log Mile	Air Temp.	Width Btwn. Dowels, in.	Joint Fault	Joint Width
C l o u d y	1	1	53.044	95° F	9.40"	0.40"	-
		2	53.076	95° F	7.85"	0.00"	1.60"
		3	53.153	95° F	6.90"	0.00"	1.30"
	2	4	53.242	95° F	10.75"	0.00"	1.10"
		5	53.322	95° F	10.90"	0.20"	2.30"
		6	53.338	95° F	10.55"	0.60"	1.80"
	3	7	53.411	95° F	8.95"	0.10"	1.20"
		8	53.456	95° F	9.20"	0.00"	1.30"
		9	53.479	95° F	10.30"	0.05"	1.20"
	4	10	53.620	95° F	10.45"	0.25"	1.00"
		11	53.710	95° F	9.00"	0.15"	0.90"
		12	53.732	95° F	10.80"	0.20"	0.80"
S u n n y	5	13	53.806	90° F	11.45"	0.35"	1.50"
		14	53.840	93° F	12.10"	0.10"	1.30"
		15	53.945	93° F	12.25"	0.15"	1.90"

TABLE 14 Cont'd

Louisiana I-20 Pre-break Joint Movement

Date of Readings: 8/30/90

Begin Log Mile at Milepost 53

	Section	Joint No.	Log Mile	Air Temp.	Width Btwm Dowels, in.	Joint Fault	Joint Width
C l o u d y	1	1	53.044	94° F	9.40"	0.36"	-
		2	53.076	94° F	7.85"	0.00"	1.60"
		3	53.153	94° F	6.95"	0.00"	1.30"
	2	4	53.242	94° F	10.80"	0.00"	1.10"
		5	53.322	94° F	11.00"	0.15"	2.30"
		6	53.338	94° F	10.75"	0.80"	1.80"
	3	7	53.411	94° F	9.00"	0.15"	1.20"
		8	53.456	94° F	9.25"	0.00"	1.30"
		9	53.479	94° F	10.30"	0.05"	1.20"
	4	10	53.620	94° F	10.55"	0.20"	1.00"
		11	53.710	94° F	9.05"	0.30"	0.90"
		12	53.732	94° F	10.80"	0.25"	0.80"
S u n n y	5	13	53.806	94° F	11.50"	0.40"	1.50"
		14	53.840	94° F	12.15"	0.00"	1.30"
		15	53.945	94° F	12.40"	0.20"	1.90"

TABLE 14 Cont'd

Louisiana I-20 Pre-break Joint Movement

Date of Readings: 9/06/91

Begin Log Mile at Mile Post 53

	Section	Joint No.	Log Mile	Air Temp.	Width Btwm Dowels, in.	Joint Fault	Joint Width
C l o u d y	1	1	53.044	71° F	9.55"	0.42"	1.50"
		2	53.076	71° F	7.85"	0.05"	1.80"
		3	53.153	71° F	6.95"	0.10"	1.40"
	2	4	53.242	71° F	10.80"	0.05"	1.20"
		5	53.322	71° F	11.10"	0.20"	2.50"
		6	53.338	71° F	11.05"	0.70"	2.10"
	3	7	53.411	71° F	9.05"	0.15"	1.30"
		8	53.456	71° F	9.25"	0.05"	1.20"
		9	53.479	71° F	10.30"	0.12"	1.25"
	4	10	53.620	71° F	10.65"	0.25"	1.20"
		11	53.710	71° F	9.05"	0.22"	1.10"
		12	53.732	71° F	10.85"	0.17"	0.80"
S u n n y	5	13	53.806	71° F	11.60"	0.30"	1.55"
		14	53.840	71° F	12.15"	0.10"	1.20"
		15	53.945	71° F	12.45"	0.20"	2.00"

This public document is published at a total cost of \$765.00. One hundred twenty copies of this public document were published in this first printing at a cost of \$465.00. The total cost of all printings of this document including reprints is \$765.00. This document was published by Louisiana State University, Graphic Services, 3555 River Road, Baton Rouge, Louisiana 70802, to report and publish research findings of the Louisiana Transportation Research Center as required by R.S. 48:105. This material was printed in accordance with standards for printing by State Agencies established pursuant to R.S. 43:31. Printing of this material was purchased in accordance with the provisions of Title 43 of the Louisiana Revised Statutes.