

1. Report No. FHWA/LA-93/267		2. Government Accession No.		3. Recipient's Catalog No.	
4. Title and Subtitle Crash Testing of Louisiana's 3 1/2" Diameter Multi-Directional, Single Steel Post, Small Sign Support				5. Report Date March 1993	
				6. Performing Organization Code	
7. Author(s) D. Lance Bullard, Jr.				8. Performing Organization Report No. 267	
9. Performing Organization Name and Address Safety Division, Texas Transportation Institute The Texas A & M University System College Station, TX 77843				10. Work Unit No.	
				11. Contract or Grant No. La. HPR Study #93-1SS(B)	
12. Sponsoring Agency Name and Address Louisiana Transportation Research Center 4101 Gourrier Avenue Baton Rouge, LA 70808				13. Type of Report and Period Covered Final Report (December 1992-March 1993)	
				14. Sponsoring Agency Code	
15. Supplementary Notes Conducted in cooperation with the U.S. Department of Transportation, Federal Highway Administration.					
16. Abstract The Louisiana Department of Transportation and Development (LDOTD) contracted with the Texas Transportation Institute (TTI) to evaluate the impact characteristics of Louisiana's multi-directional, 8.9 cm (3-1/2 in) diameter steel post, small sign support when impacted by an 820 kg (1,808 lb) vehicle at 35 km (22 mi/h) and 100 km/h (62 mi/h). The full-scale crash tests were conducted and evaluated in accordance with the criteria provided in the 1985 American Association of State Highway and Transportation Officials (AASHTO) Guide: <u>Standards Specifications for Structural Supports for Highway Signs, Luminaries, and Traffic Signals</u> and the National Cooperative Highway Research Program (NCHRP) Draft Report 350. Both the low and high-speed impact tests satisfied the test criteria by: (1) the sign support yielding to the vehicle, (2) the sign installation and vehicle presented no undue hazard to other motorist after impact and (3) occupant risk values were well below the maximum allowable levels. This sign installation in "standard soil" is acceptable according to the test level 3 evaluation criteria recommended in NCHRP Report 350 and the 1985 AASHTO Standards.					
17. Key Words Crash testing, multi-directional bases, small sign supports.			18. Distribution Statement Unrestricted. This document is available to the public through the National Technical Information Service, Springfield, Virginia 21161.		
19. Security Classif. (of this report) Unclassified		20. Security Classif. (of this page) Unclassified		21. No. of Pages 41	22. Price

CRASH TESTING OF LOUISIANA'S
3 1/2" DIAMETER MULTI-DIRECTIONAL,
SINGLE STEEL POST, SMALL SIGN SUPPORT

FINAL REPORT
BY

D. LANCE BULLARD, JR.
ENGINEERING RESEARCH ASSOCIATE

RESEARCH REPORT NO. 267
RESEARCH PROJECT NO. 93-1SS(B)

Conducted by
SAFETY DIVISION, TEXAS TRANSPORTATION INSTITUTE,
THE TEXAS A&M UNIVERSITY SYSTEM
COLLEGE STATION, TEXAS 77843
and
LOUISIANA TRANSPORTATION RESEARCH CENTER,
LOUISIANA DEPARTMENT OF TRANSPORTATION AND DEVELOPMENT
In Cooperation With
U.S. DEPARTMENT OF TRANSPORTATION
FEDERAL HIGHWAY ADMINISTRATION

The contents of this report reflect the views of the authors who are responsible for the facts and the accuracy of the data presented herein. The contents do not necessarily reflect the official views or policies of the State or Federal Highway Administration. This report does not constitute a standard, specification, or regulation. The Louisiana Department of Transportation and Development and the Louisiana Transportation Research Center do not endorse products, equipment or manufacturers.

March 1993

ABSTRACT

The Louisiana Department of Transportation and Development (LDOTD) contracted with the Texas Transportation Institute (TTI) to evaluate the impact characteristics of Louisiana's multi-directional, 8.9 cm (3-1/2 in) diameter steel post, small sign support when impacted by an 820 kg (1,808 lb) vehicle at 35 km (22 mi/h) and 100 km/h (62 mi/h). The full-scale crash tests were conducted and evaluated in accordance with the criteria provided in the 1985 American Association of State Highway and Transportation Officials (AASHTO) Guide: Standards Specifications for Structural Supports for Highway Signs, Luminaires, and Traffic Signals and the National Cooperative Highway Research Program (NCHRP) Draft Report 350.

Both the low and high-speed impact tests satisfied the test criteria by: (1) the sign support yielding to the vehicle (2) the sign installation and vehicle presented no undue hazard to other motorist after impact and (3) occupant risk values were well below the maximum allowable levels. This sign installation in "standard soil" is acceptable according to the test level 3 evaluation criteria recommended in NCHRP Report 350 and the 1985 AASHTO Standards.

IMPLEMENTATION STATEMENT

LDOTD has been involved since 1990 in the pooled funded HPR-2(144), Testing of Small and Large Sign Supports, which crash tested various state's current sign standards to determine if they meet the new AASHTO crashworthiness criteria. The Oregon DOT's small sign support details were tested and failed when the stub risers dug into the bottom surface of the top slip plate. This could prove devastating to the department if it were required to remove and replace all existing small sign supports of this type. LDOTD'S Bridge Design section felt that their design of the multi-directional slip base system would meet the new AASHTO criteria.

LDOTD's design of the 3 1/2" diameter, single steel post, multi-directional slip base sign support proved to be successful in meeting the AASHTO criteria for the crash tests performed. The department plans to continue the use of its current system and will not have to remove and replace thousands of existing signs with a new system.

TABLE OF CONTENTS

ABSTRACT	iii
IMPLEMENTATION STATEMENT	v
LIST OF FIGURES	ix
I. INTRODUCTION	1
II. STUDY APPROACH	3
Description of Test Installations	3
Description of Crash Test Procedures	3
III. INSTRUMENTATION AND DATA ANALYSIS	9
Electronic Instrumentation and Data Processing	9
Photographic Instrumentation and Data Processing	10
Evaluation Criteria	10
Test Vehicle Propulsion and Guidance	12
IV. CRASH TEST RESULTS	13
Test 7222-1	13
Test 7222-2	26
V. CONCLUSION	41

LIST OF FIGURES

<u>Figure</u>		<u>Page</u>
1	Multi-directional slip-base, single steel sign support installation	4
2	Details of multi-directional slip-base, single steel sign support installation	5
3	3 1/2" multi-directional slip-base sign support installation as tested	7
4	Vehicle/sign geometrics for test 7222-1	14
5	Vehicle prior to test 7222-1	15
6	Vehicle properties for test 7222-1&2	16
7	Sign installation after test 7222-1	17
8	Sequential photographs for test 7222-1 (perpendicular and side views)	18
9	Damage sustained to vehicle during test 7222-1	20
10	Data summary for test 7222-1	21
11	Vehicle angular displacements for test 7222-1.	22
12	Longitudinal accelerometer trace for test 7222-1	23
13	Lateral accelerometer trace for test 7222-1	24
14	Vertical accelerometer trace for test 7222-1	25
15	Vehicle prior to test 7222-2	27
16	Vehicle/sign geometrics for test 7222-2	28
17	Sign installation after test 7222-2	29
18	Sequential photographs for test 7222-2 (perpendicular and side views)	31
19	Damage sustained to vehicle during test 7222-2	33
20	Data summary for test 7222-2	35
21	Vehicle angular displacements for test 7222-2	36
22	Longitudinal accelerometer trace for test 7222-2	37
23	Lateral accelerometer trace for test 7222-2	38
24	Vertical accelerometer trace for test 7222-2	39

INTRODUCTION

The Louisiana Department of Transportation and Development (herein referred to as the Department) contracted with the Texas Transportation Institute (TTI) to conduct two full-scale crash tests on multi-directional, single steel post, small sign support installations installed in standard soil.

The objective of these crash tests was to evaluate the impact characteristics of Louisiana's multi-directional, single 3-1/2 inch diameter steel post, small sign support when impacted by 820 kg (1,808 lb) vehicles at 35 km/h (20.0 mi/h) and 100 km/h (62 mi/h). The sign installation was evaluated on its ability to perform in a safe and predictable manner. The crash test was conducted and evaluated in accordance with criteria provided in the 1985 American Association of State Highway and Transportation Officials (AASHTO) Guide: Standards Specifications for Structural Supports for Highway Signs, Luminaires, and Traffic Signals and the National Cooperative Highway Research Program (NCHRP) Draft Report 350 test level 3.

This page left blank intentionally.

STUDY APPROACH

Description of Test Installations

A single-support sign installation was constructed from 8.9 cm (3-1/2 in) diameter schedule 40 steel pipe. The ground stub was anchored in a 0.5 m (1 ft-6 in) dia. x 0.9 m (3 ft-0 in) concrete footing placed in NCHRP Report 350 standard soil. The length of the sign support was 3.0 m (10 ft-0 in) and the ground stub was 0.9 m (3 ft-0 in) as shown in Figure 1. The post and ground stub were fitted with a multi-directional slip base. The slip-base connection utilized 1.6 cm (5/8 in) diameter high strength bolts torqued to 25.5 N-m (226 in-lb), as specified in Louisiana DOTD standards. Attached to the support was a 1.2 m x 1.2 m (4 ft x 4 ft) type A octagon sign panel. The sign panel was mounted to two Z-stiffeners with machine bolts. Each stiffener was attached to a flared leg mounting bracket with 2 bolts (5/16"-18 N.C.). A 1.9 cm (3/4 in) strap attached the sign blank assembly to the mounting brackets and support. The bottom of the sign panel mounting height was 2.0 m (6 ft-6 in) to the roadway. Figures 1 and 2 illustrate construction details of the sign installation. Figure 3 shows the actual sign installation as tested.

Description of Crash Test Procedures

According to NCHRP Report 350 guidelines, two crash tests are recommended for the evaluation of single support sign installations:

NCHRP Test Designation 60: 820C (1,808 lb) vehicle impacting the sign support at a speed of 35 km/h (22 mi/h) with the quarter point of the vehicle bumper.

NCHRP Test Designation 61: 820C (1,808 lb) vehicle impacting the sign support at a speed of 100 km/h (62 mi/h) with the quarter point of the vehicle bumper.

The crash test procedures were in accordance with the guidelines presented in NCHRP Report 350. The test inertia weight of the crash vehicle was 820 kg (1,808 lb). This weight represents the weight of the test vehicle and all rigidly attached on-board test equipment. In addition, the gross static weight was 896 kg (1,975 lb). The gross static weight is the sum of the vehicle inertial weight and an unrestrained anthropomorphic dummy.

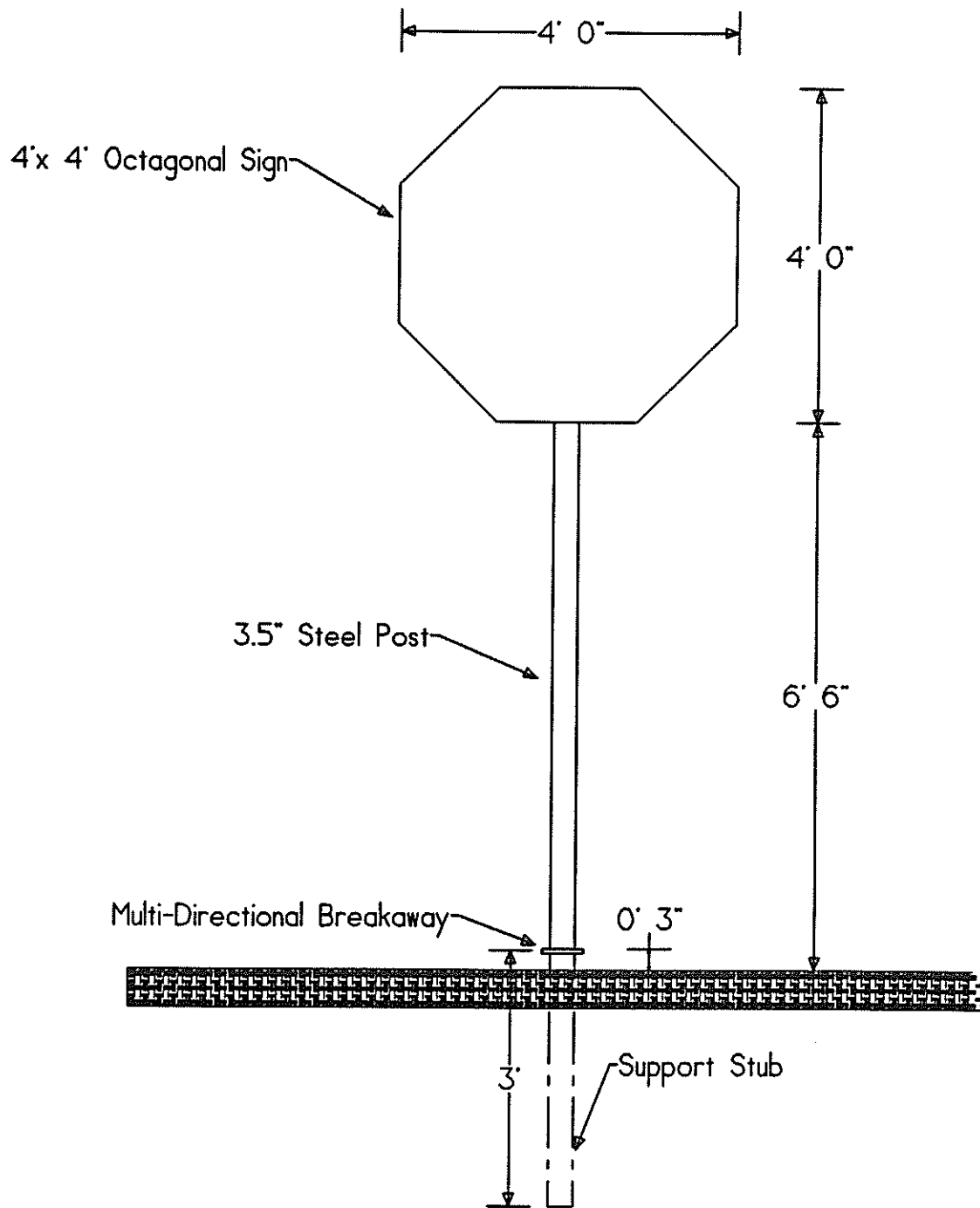
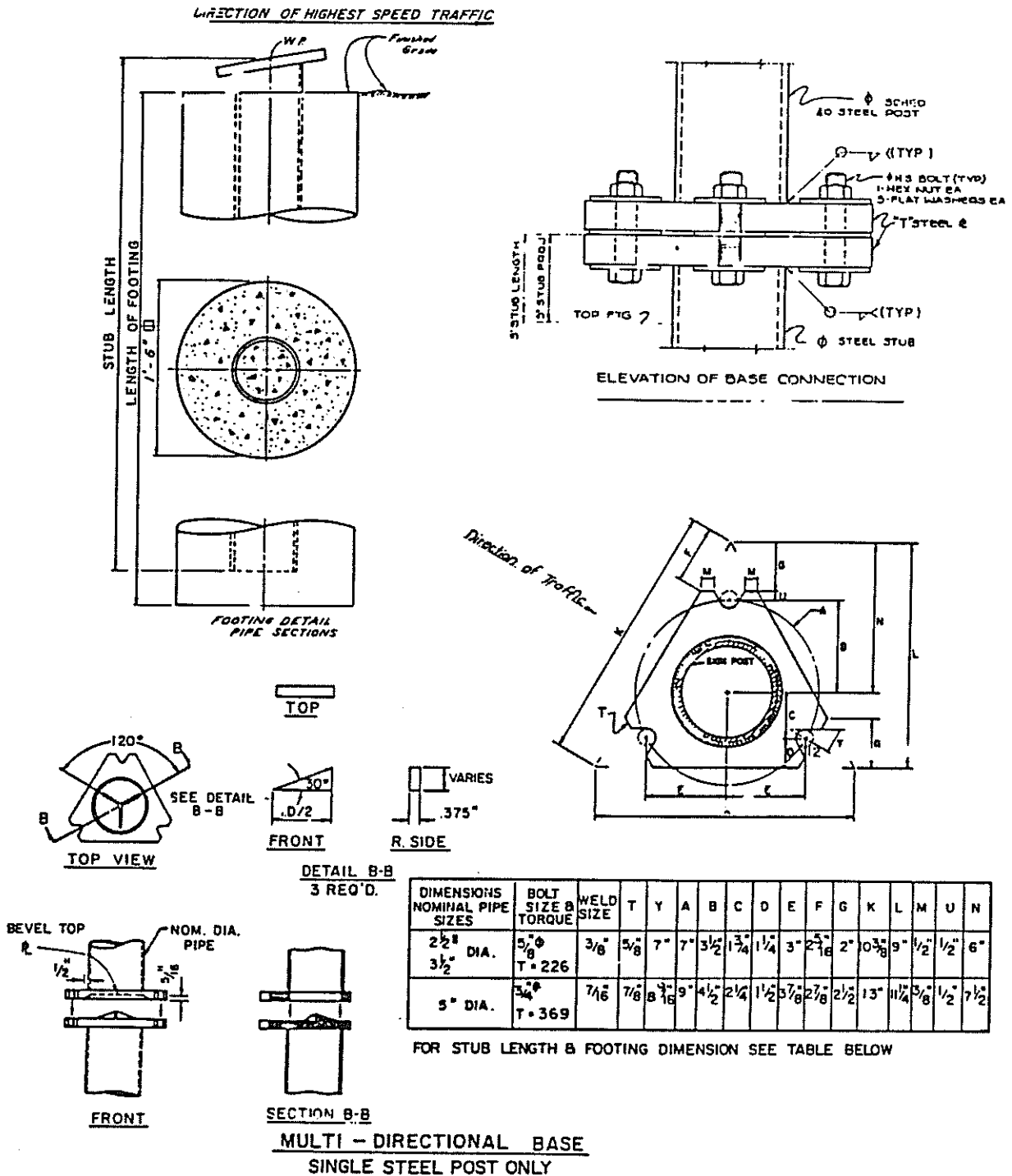
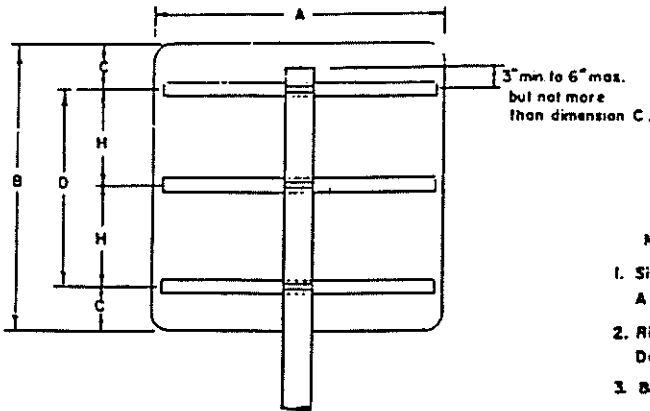

Figure 1. Multi-directional slip base, single steel sign support installation.



NOTE:
MULTI-DIRECTIONAL BREAK-AWAY FEATURE IS TO BE USED ONLY AT LOCATIONS WHERE SIGN IS LIKELY TO BE STRUCK FROM MORE THAN ONE COMMON DIRECTION.

Figure 2. Details of Multi-directional slip base, single steel sign support installation.



NOTES:

1. Sign Blanks shall be 0.080 inch Aluminum Alloy 6061-T6 or 5052-H38 A.S.T.M. Designation B-209.
2. Rivets shall be 3/16" ϕ Aluminum Alloy 2024-T4, A.S.T.M. Designation B-316. Rivet Head Shall Be 3/8" Max. Diameter.
3. Bolt shall be as required by applicable Mounting Detail Type.
4. Stiffeners shall be Aluminum Alloy 6061-T6, A.S.T.M. Designation B-221. Stiffeners may be 1/2" x 1/2" Bar, 2" x 1/4" x 1.07 or 2" x 3/4" x 1.08 at the Contractors Option, Unless Otherwise Noted.
5. Nylon Washers shall be Furnished for Sign Face Protection
6. Sign Mounting Bracket, Strap and Seal Required for Mounting Detail (Type I) Shall be A.S.T.M. A167 Type 301 or Approved Equal. Hardware Shall be A.S.T.M. A167 Type 301 or Approved Equal.
7. Sign Mounting Hardware Required for Mounting Detail (Type II) Shall be Hot Dipped Galvanized, A.S.T.M. A153 after Fabrication or Electroplated, A.S.T.M. B633 SC4, Type 1 Zinc Coating. Bolt Holes in Sign Support Shall be Field Drilled.

SQUARE, RECTANGLE, CIRCLE, OCTAGON and ROUTE MARKERS

A	B	C	D	H	STIFFENER	
					number required	
Variable 12" to 48"	6	3			1 when A \geq 36	
	12	6			1 when A \geq 36	
	15	7.5			1 when A \geq 36	
	18	9			1 when A \geq 36	
	24	6		12	2 when A \geq 36	
	30	7.5		15	2 when A \geq 36	
	36	7.5		21	2	
	48	10		28	2	
	60	9		42	21	3
	72	11		ϕ 6	25	3
84	10.5		ϕ 6	21	4	
48	96	12	ϕ 6	24	4	

ϕ LOCATION OF BORDER ANGLE FROM EDGE

TYPE A SIGNS

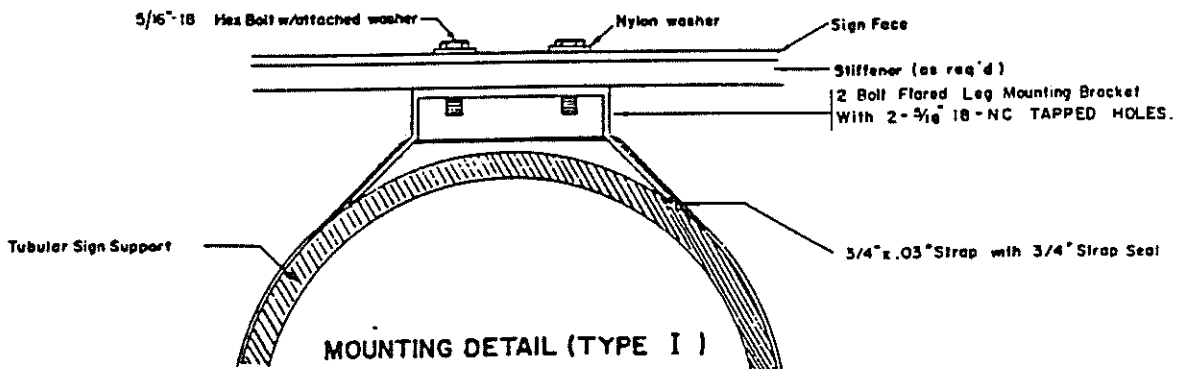

Figure 2. Details of Multi-directional slip base, single steel sign support installation (cont.).

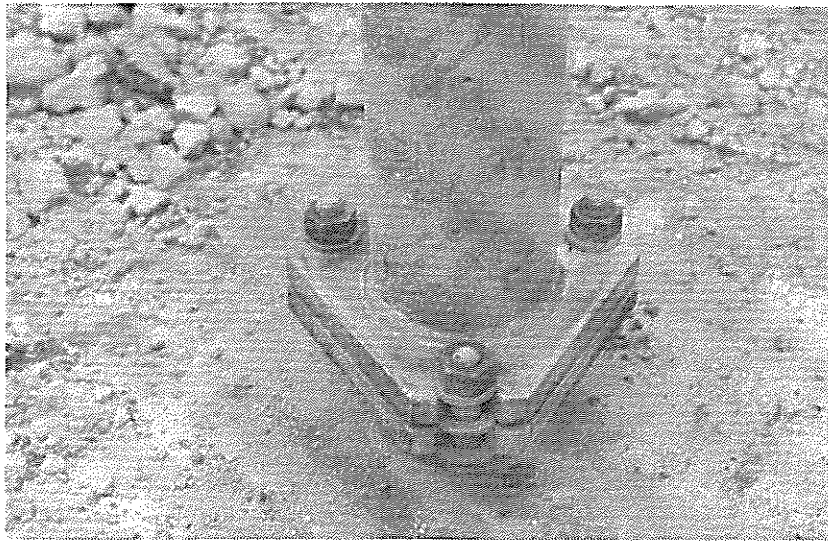
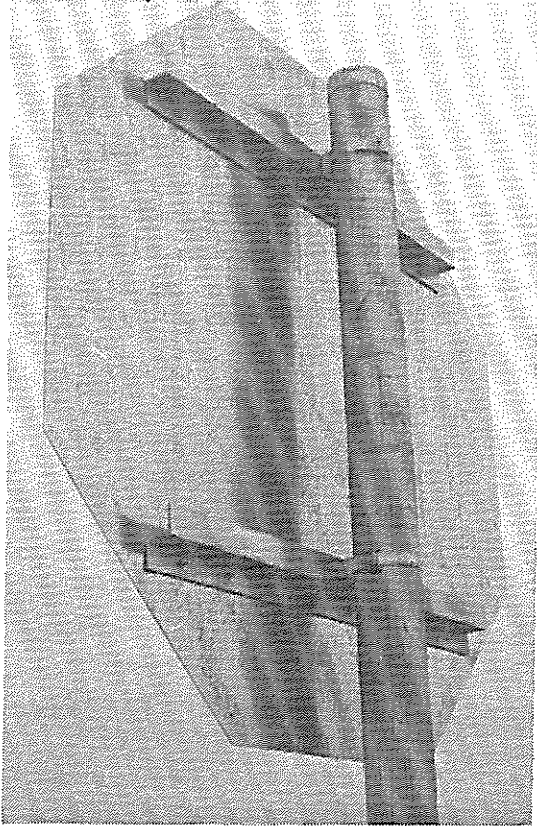

Figure 3. 3 1/2" multi-directional slip base sign support installation as tested.

This page left blank intentionally.

INSTRUMENTATION AND DATA ANALYSIS

Electronic Instrumentation and Data Processing

The test vehicle was instrumented with three solid-state angular rate transducers to measure yaw, pitch and roll rates; a triaxial accelerometer at the vehicle center-of-gravity to measure longitudinal, lateral, and vertical acceleration levels, and a back-up biaxial accelerometer in the rear of the vehicle to measure longitudinal and lateral acceleration levels. The accelerometers were strain gauge type with a linear millivolt output proportional to acceleration.

The electronic signals from the accelerometers and transducers were transmitted to a base station by means of constant bandwidth FM/FM telemetry link for recording on magnetic tape and for display on a real-time strip chart. Provision was made for the transmission of calibration signals before and after the test, and an accurate time reference signal was simultaneously recorded with the data. Pressure sensitive contact switches on the bumper were actuated just prior to impact by wooden dowels to indicate the elapsed time over a known distance to provide a measurement of impact velocity. The initial contact also produced an "event" mark on the data record to establish the exact instant of contact with the barrier.

The multiplex of data channels, transmitted on one radio frequency, was received at a data acquisition station, and demultiplexed into separate tracks of Intermediate Range Instrumentation Group (I.R.I.G.) tape recorders. After the test, the data was played back from the tape machines, filtered with a SAE J211 Class 180 filter, and were digitized using a microcomputer, for analysis and evaluation of impact performance. The digitized data were then processed using two computer programs: DIGITIZE and PLOTANGLE. Brief descriptions on the functions of these two computer programs are as follows.

The DIGITIZE program uses digitized data from vehicle-mounted linear accelerometers to compute occupant/compartiment impact velocities, time of occupant/compartiment impact after vehicle impact, and the highest 10-millisecond average ridedown acceleration. The DIGITIZE program also calculates a vehicle impact velocity and the change in vehicle velocity at the end of a given impulse period. In addition, maximum average accelerations over 50-millisecond intervals in each of the three directions

are computed. Acceleration versus time curves for the longitudinal, lateral, and vertical directions are then plotted from the digitized data of the vehicle-mounted linear accelerometers using a commercially available software package (QUATTRO PRO).

The PLOTANGLE program uses the digitized data from the yaw, pitch, and roll rate charts to compute angular displacement in degrees at 0.00067-second intervals and then instructs a plotter to draw a reproducible plot: yaw, pitch, and roll versus time. It should be noted that these angular displacements are sequence dependent with the sequence being yaw-pitch-roll for the data presented herein. These displacements are in reference to the vehicle-fixed coordinate system with the initial position and orientation of the vehicle-fixed coordinate system being that which existed at initial impact.

An unrestrained, uninstrumented special-purpose 50th percentile anthropomorphic test dummy was positioned in the front seat of the test vehicle. The dummy was used to create an asymmetrical vehicle mass distribution. The effect of this load configuration was used to evaluate vehicle stability during impact.

Photographic Instrumentation and Data Processing

Photographic coverage of the test included two high-speed cameras; one placed with a field of view perpendicular to the side of the installation and one placed downstream from impact at approximately a 45 degree angle to impact. A flash bulb activated by a pressure sensitive tape switch was positioned on the impacting vehicle to indicate the instant of contact with the sign support and was visible from each camera. The films from these high-speed cameras were analyzed on a computer-linked motion analyzer to, (1) observe phenomena occurring during the collision, (2) to obtain time-event and displacement, and (3) as a back-up for the angular data. A professional video camera, 3/4-in video recorder and 35-mm cameras were used for documentary purposes to record conditions of the test vehicle and sign installation before and after the test.

Evaluation Criteria

All crash tests were evaluated in accordance with the criteria presented in NCHRP Draft Report 350 and 1985 AASHTO. The safety performance of a highway appurtenance

can be judged on the basis of one or more of the following three principle performance factors: structural adequacy, occupant risk, and post-collision vehicle trajectory. In accordance, the following safety evaluation criteria from Table 5.1, NCHRP Report 350 were used:

- Structural adequacy

(B) The test article shall readily activate in a predictable manner by breaking away, fracturing or yielding.

- Occupant Risk

(D) Detached elements, fragments or other debris from the test-article should not penetrate or show potential for penetrating the passenger compartment or present undue hazard to other traffic, pedestrians, or personnel in a work zone. Deformations of, or intrusions into, the occupant compartment that could cause serious injuries should not be permitted.

(F) The vehicle shall remain upright during and after collision although moderate roll, pitching and yawing are acceptable.

(H) Impact velocity of hypothetical front seat passenger against vehicle interior, calculated from the vehicle accelerations and 0.6 m (24 in) forward and 0.3 m (12 in) lateral displacement, shall be less than:

	<u>Occupant Impact Velocity - mps</u>	
	<u>Preferred</u>	<u>Maximum</u>
Longitudinal	3 (9.8 ft/s)	5 (16.4 ft/s)

(I) Highest 10 ms average occupant ridedown accelerations subsequent to instant of hypothetical passenger impact should be less than:

	<u>Occupant Ridedown Accelerations - g's</u>	
	<u>Preferred</u>	<u>Maximum</u>
Longitudinal and Lateral	15	20

- Vehicle Trajectory

(N) Vehicle trajectory behind the test article is acceptable.

In addition, 1985 AASHTO states:

Satisfactory dynamic performance is indicated when the maximum change in velocity for a standard 1,800 pound (816.5 kg) vehicle, or its equivalent, striking a breakaway support at speeds from 20 mi/h to 60 mi/h (32 km/h to 97 km/h) does not exceed 15 fps (4.57 mps), but preferably does not exceed 10 fps (3.05 mps) or less.

It should be noted, 1985 AASHTO was amended in Vol. 54, No.3 of the Federal Register (01/05/89) to allow a maximum change in velocity of 4.9 m/s (16 ft/s).

Test Vehicle Propulsion and Guidance

The test vehicle was towed into the test installation using a steel cable guidance and reverse tow system. A steel cable for guiding the test vehicle was tensioned along the vehicle travel path. The guide cable was threaded through a guide rod attached to the front spindle of the test vehicle. An additional steel cable was attached to the front of the test vehicle, passed to and around a pulley near the impact point, and to and around an additional pulley mounted to the tow vehicle, and then anchored to the ground. This configuration allowed the tow vehicle to move away from the test site with a 2 to 1 speed ratio existing between the test vehicle and tow vehicle. Immediately prior to impact with the sign installation, the test vehicle was released to be free-wheeling and unrestrained. The vehicle remained free-wheeling, i.e., no steering or braking inputs, until the vehicle cleared the immediate area of the test site, at which time brakes on the vehicle were activated to bring the vehicle to a safe and controlled stop.

CRASH TEST RESULTS

Test 7222-1

A 1988 Subaru Justy (shown in Figures 4 & 5) impacted a 8.9 cm (93-1/2 in) diameter steel pipe, multi-directional slip-base, sign installation in standard soil. The impact was at 35.7 km/h (22.2 mi/h) using a cable reverse tow and guidance system. The point of impact was the front left quarter point of the vehicle bumper with the sign installation. Test inertia weight of the vehicle was 1,808 lb (820 kg) and its gross static weight was 1,976 lb (896 kg). The height from roadway surface to the lower edge of the vehicle bumper was 32.5 cm (12.8 in) and 50.5 cm (19.9 in) to the top of the bumper. Other dimensions and information on the vehicle are given in Figure 6.

The vehicle was free wheeling and unrestrained just prior to impact. Shortly after impact, the sign support displaced the bolts in the slip-base and began to rise up off the base plate. By approximately 0.034 seconds, the vehicle had temporarily lost contact with the support. As the vehicle continued to move forward, the support was displaced over the vehicle. The sign panel and, subsequently, the end of the support impacted the roof (at the top of the rear hatchback) of the vehicle at approximately 0.408 second. The vehicle lost contact with the sign support at 0.692 second. At approximately 2.5 seconds after impact, the brakes were applied and the vehicle came to rest 24.1 m (79.0 ft) from the point of impact as shown in Figure 7. Sequential photographs of the test are shown in Figure 8.

The installation yielded to the vehicle. Damage sustained to the sign installation is shown in Figure 7. The sign support came to rest 18.5 ft (5.6 m) from the point of impact. The vehicle sustained very minimal damage to the bumper and hood as shown in Figure 9. Maximum crush to the vehicle was 2.5 cm (1.0 in), located at the rear left side of the roof.

A summary of the test results and other information pertinent to this test are given in Figure 10. The maximum 0.050 second average acceleration experienced by the vehicle was -0.9 g in the longitudinal direction and 0.3 g in the lateral direction. Vehicle angular displacements are plotted in Figure 11 and vehicle accelerometer traces are displayed in Figures 12 through 14. Occupant impact velocity in the longitudinal and lateral direction are not applicable to this test, as theoretical occupant displacement did not reach 0.6 m (2.0 ft) longitudinal or 0.3 m (1 ft) lateral. Occupant ridedown accelerations were not

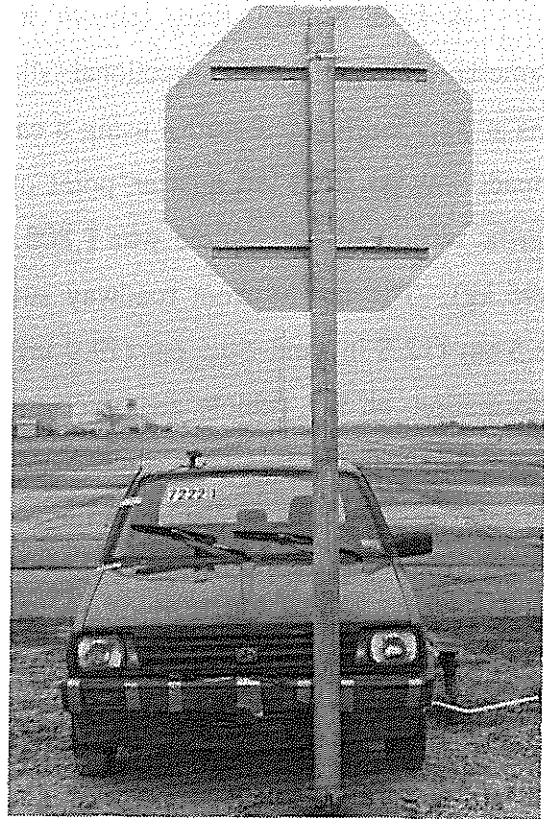
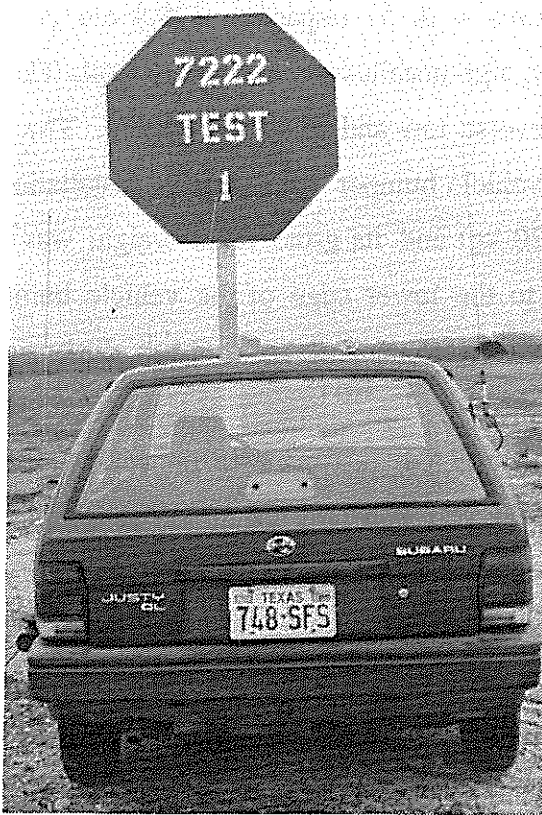

Figure 4. Vehicle/sign geometrics for test 7222-1.

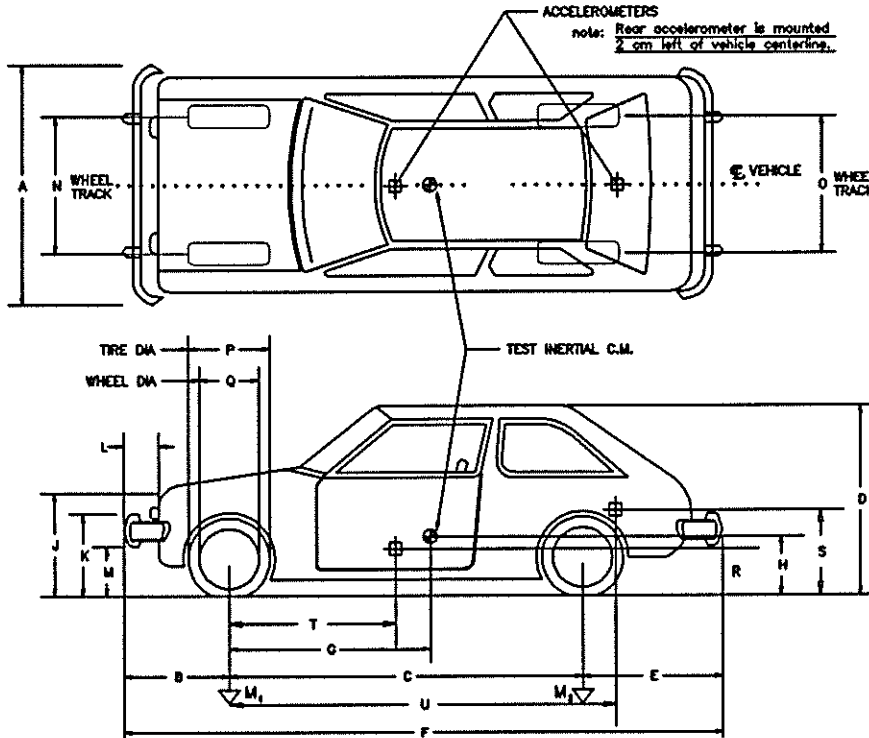

Figure 5. Vehicle prior to test 7222-1.

DATE: 12/21/92 TEST NO.: 7222-1&2 VIN NO.: JFLKA72A4JB704721 MAKE: Subaru
 MODEL: Justy YEAR: 1988 ODOMETER: 83726 TIRE SIZE: 155R12
 TIRE INFLATION PRESSURE: _____

MASS DISTRIBUTION (kg) LF 261.0 RF 253.0 LR 149.0 RR 157.0

DESCRIBE ANY DAMAGE TO VEHICLE PRIOR TO TEST:



ENGINE TYPE: 3 Cylinder

ENGINE CID: 73.0

TRANSMISSION TYPE:

AUTO
 MANUAL

OPTIONAL EQUIPMENT:

N/A

DUMMY DATA:

TYPE: _____

MASS: _____

SEAT POSITION: _____

GEOMETRY - (cm)

A	<u>153.5</u>	E	<u>55.0</u>	J	<u>72.0</u>	N	<u>135.5</u>	R	<u>39.5</u>
B	<u>63.0</u>	F	<u>346.5</u>	K	<u>50.5</u>	O	<u>129.5</u>	S	<u>76.0</u>
C	<u>228.5</u>	G	<u>85.3</u>	L	<u>9.0</u>	P	<u>56.0</u>	T	<u>84.0</u>
D	<u>135.5</u>	H	_____	M	<u>32.5</u>	Q	<u>33.5</u>	U	<u>255.5</u>

<u>MASS - (kg)</u>	<u>CURB</u>	<u>TEST INERTIAL</u>	<u>GROSS STATIC</u>
M ₁	_____	<u>514</u>	<u>553</u>
M ₂	_____	<u>306</u>	<u>343</u>
M _T	_____	<u>820</u>	<u>896</u>

Figure 6. Vehicle properties for test 7222-1&2.

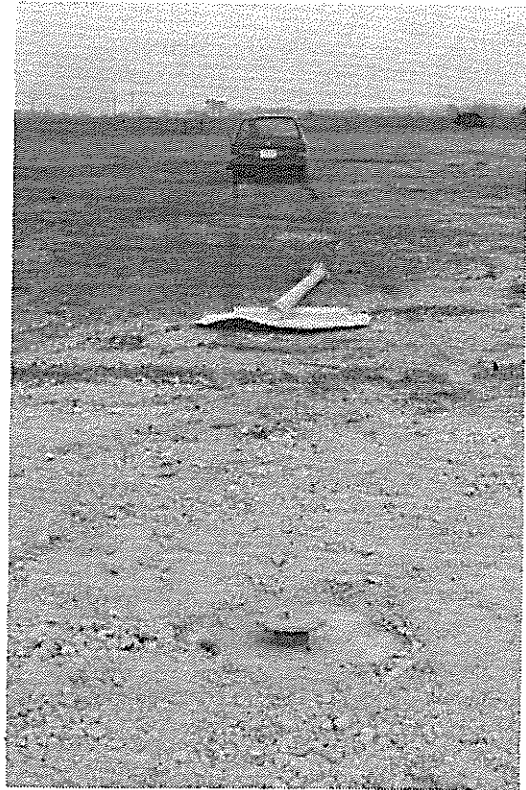
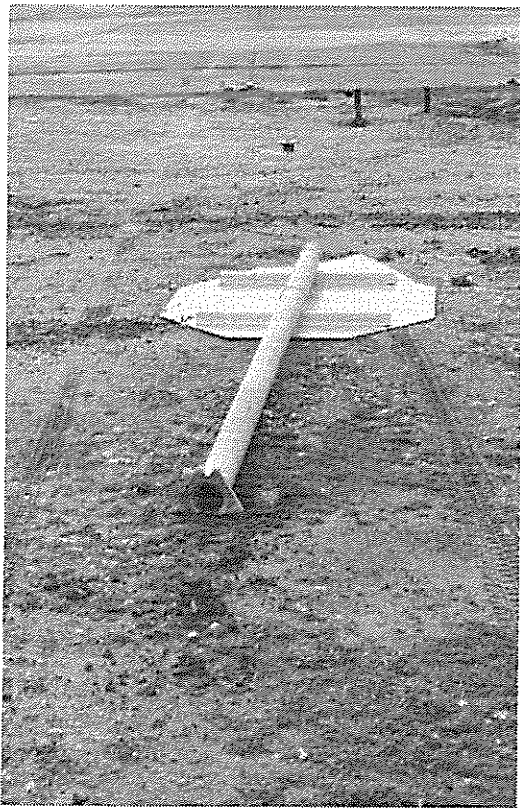
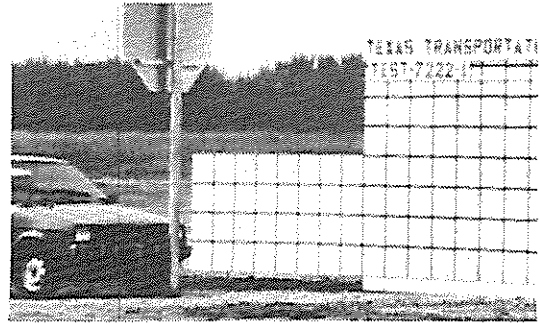
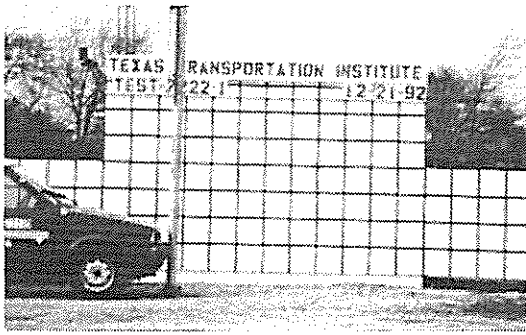
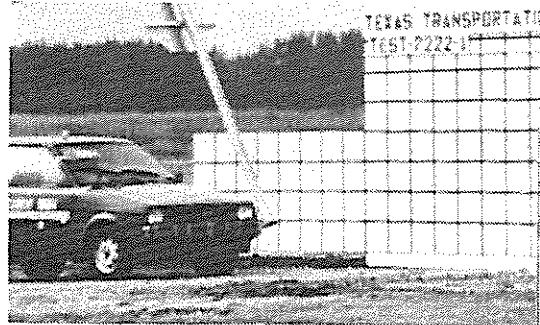
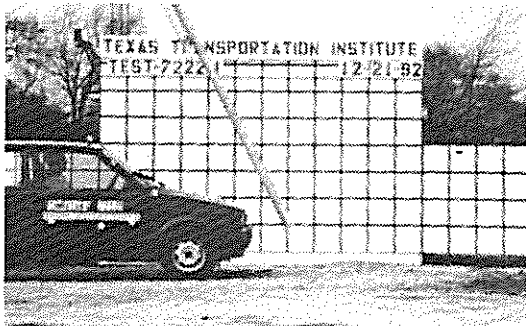

Figure 7. Sign installation after test 7222-1.



0.000 s



0.100 s

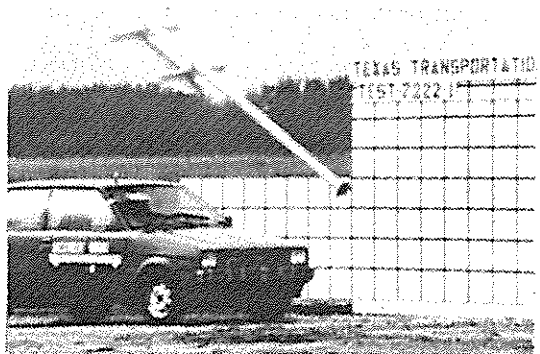
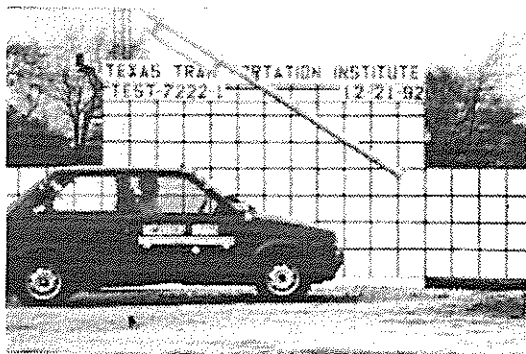

0.199 s



0.299 s

Figure 8. Sequential photographs for test 7222-1 (perpendicular and side views).

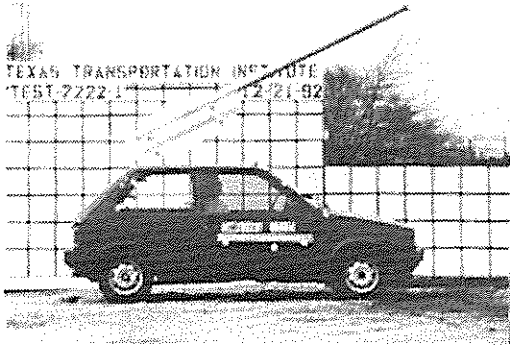

0.398 s

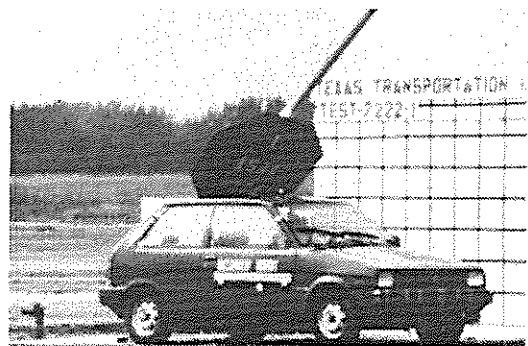

0.498 s



0.597 s

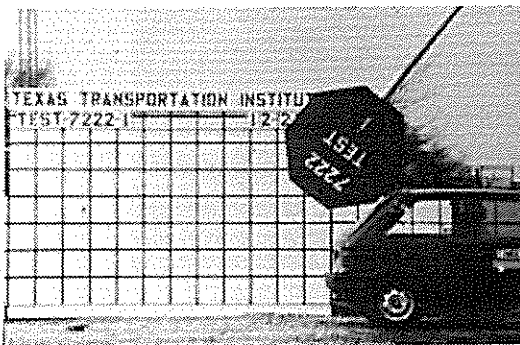

0.697 s

Figure 8. Sequential photographs for test 7222-1 (perpendicular and side views) cont.



Figure 9. Damage sustained to vehicle during test 7222-1.

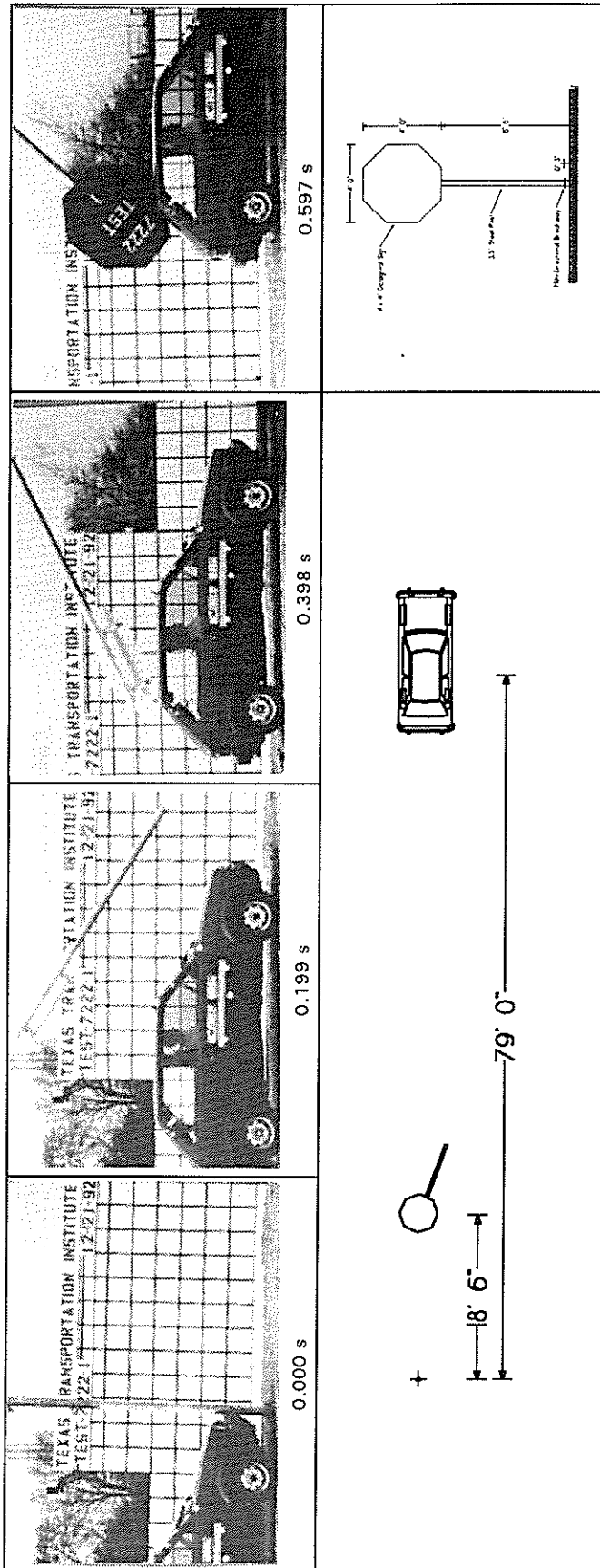

General Information		Impact Conditions		Test Article Deflections(m)	
Test Agency	Texas Transportation Institute	Speed (km/h)	35.7 (22.2 mi/h)	Dyanmic	N/A
Test No.	7222-1	Angle (deg)	0	Permanent	N/A
Date	12/21/92	Exit Conditions		Vehicle Damage	
Test Article	8.9 cm (3-1/2 in) steel, multi-directional slip base sign support	Speed (km/h)	32.9 (20.5 mi/h)	Exterior	
Type		Angle (deg)	0	VDS	12FC-1
		Occupant Risk Values		CDC	12FLLN1
Size and/or dimension and material of key elements	2.0 m (6'-6") from roadway to bottom of sign panel	Impact Velocity (m/s)		Interior	
Soil Type and Condition	NCHRP Report 350 - "Standard Soil"	x-direction	N/A	OCDI	N/A
Test Vehicle		y-direction	N/A	Maximum Exterior	
Type	Production Model	THIV (optional)		Vehicle Crush (cm)	2.5 (1.0 in)
Designation	820C	Ridedown Accelerations (g's)		Max. Occ. Compart.	
Model	1988 Subaru Justy	x-direction	No contact	Deformation (cm)	0.0
Mass (kg)	Curb	y-direction	No contact	Post-Impact Behavior	
Test Inertial	820 kg (1,808 lb)	PHD (optional)		Max. Roll Angle (deg)	1.2
Dummy	76 kg (168 lb)	ASI (optional)		Max. Pitch Angle (deg)	-1.2
Gross Static	1,976 (896 kg)	Max. 0.050-sec Averages (g's)		Max. Yaw Angle (deg)	-1.4
		x-direction	-0.9		
		y-direction	-0.3		

Figure 10. Data summary for test 7222-1.

7222-1

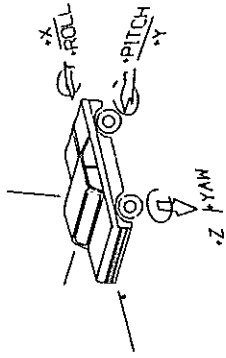

Axes are vehicle fixed.
Sequence for determining
orientation is:

1. Yaw
2. Pitch
3. Roll

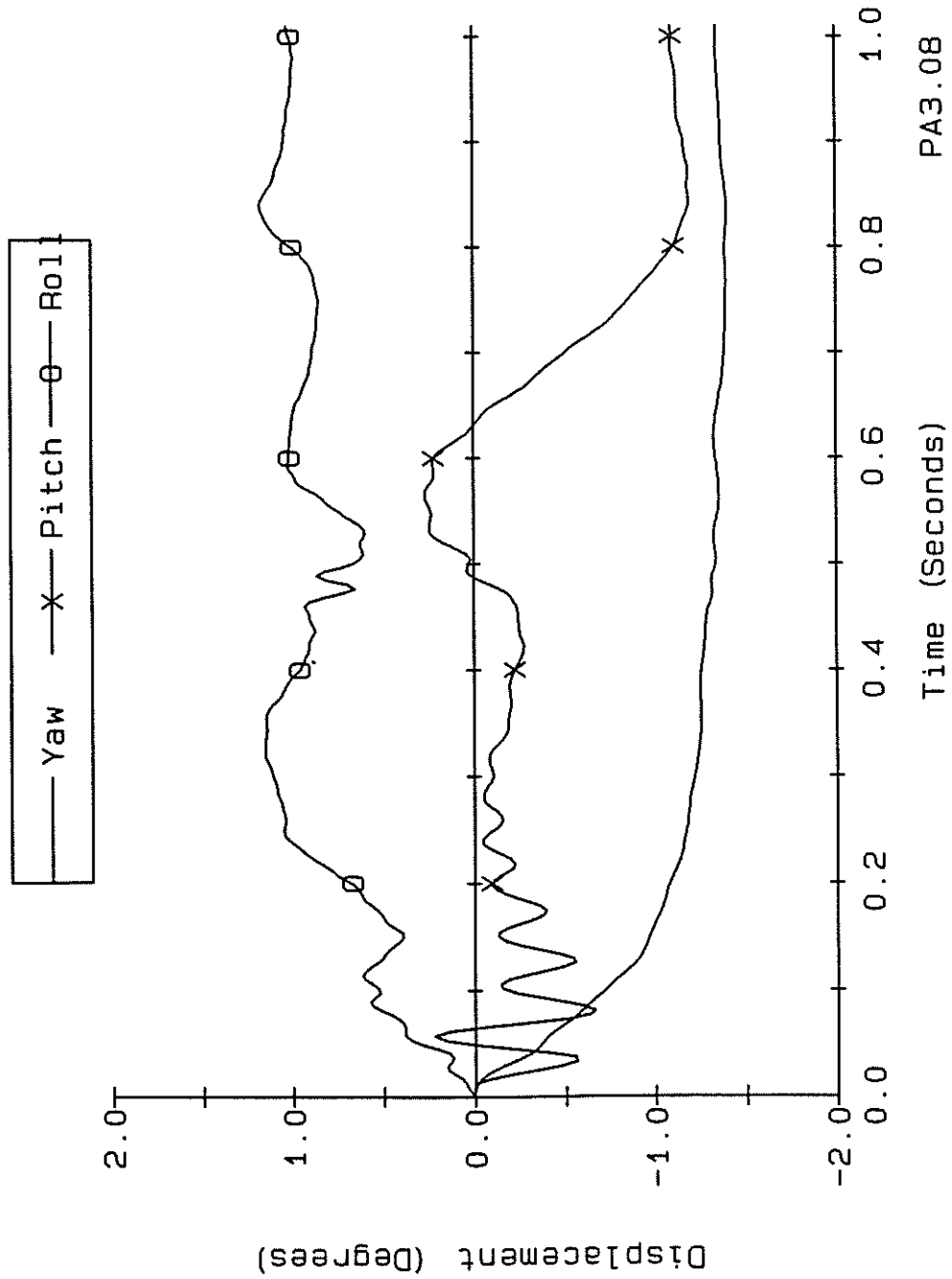

Figure 11. Vehicle angular displacements for test 7222-1.

Crash Test 7222-1
Class 60 Filter

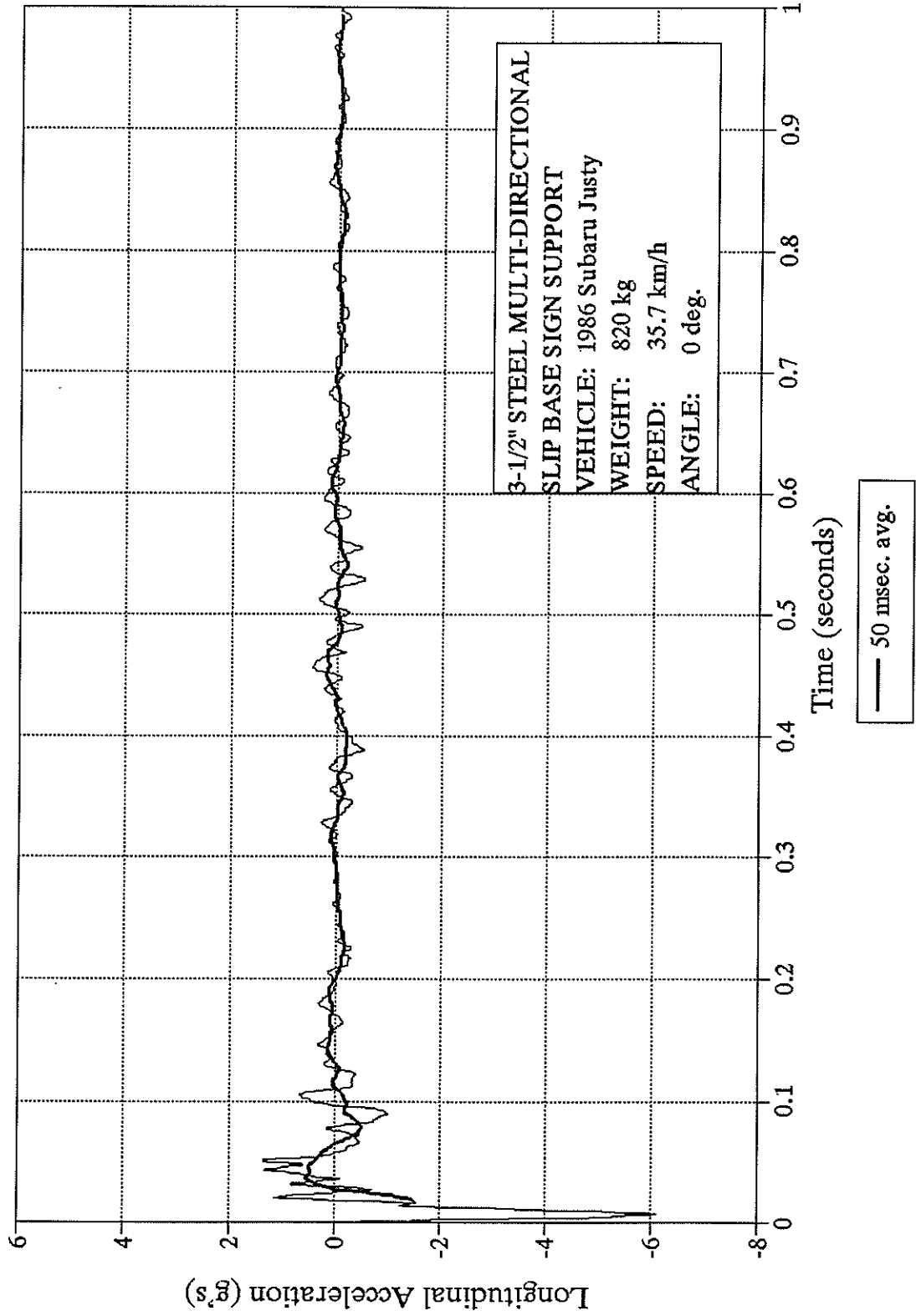

Figure 12. Longitudinal accelerometer trace for test 7222-1.

Crash Test 7222-1
Class 60 Filter

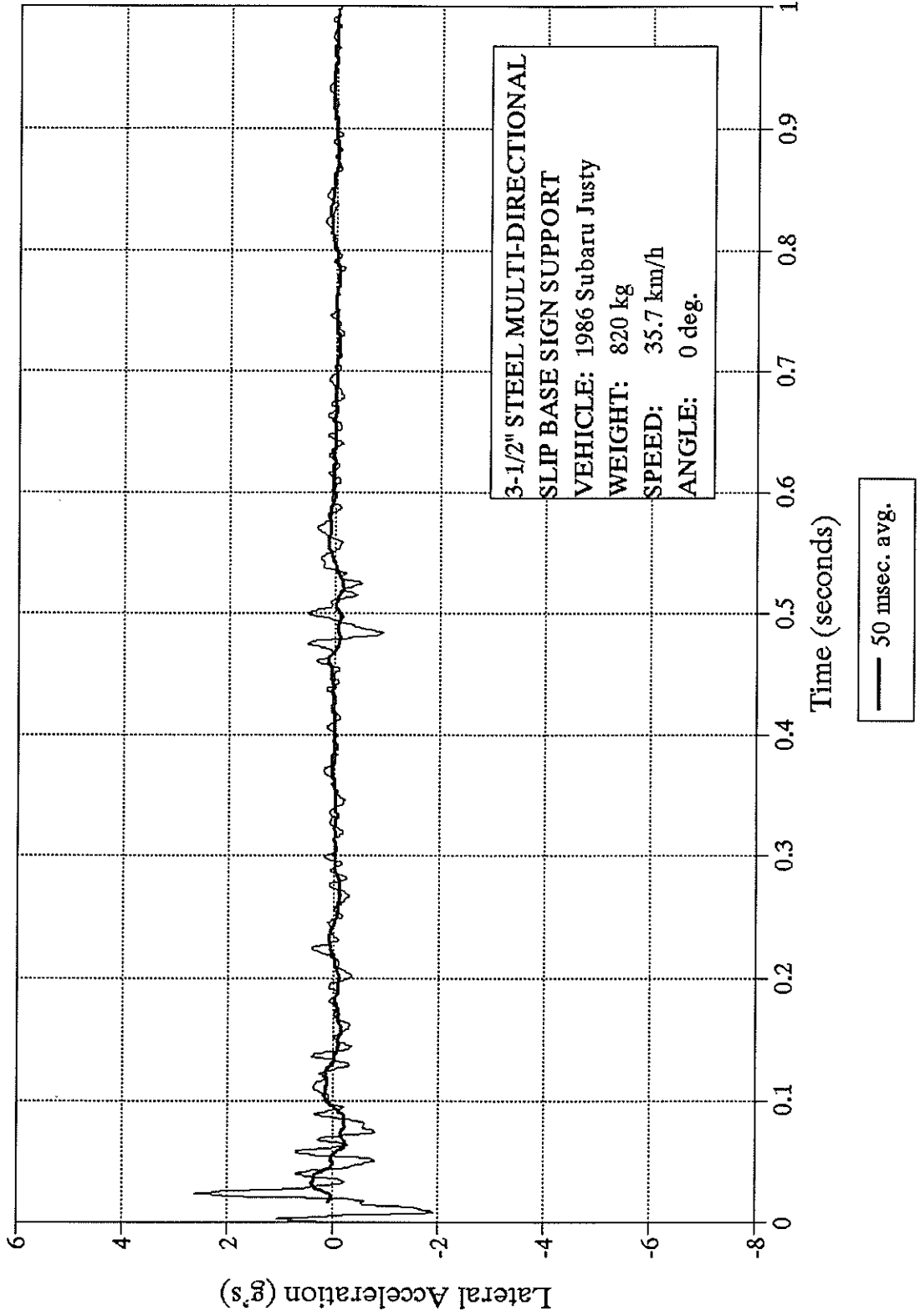

Figure 13. Lateral accelerometer trace for test 7222-1.

Crash Test 7222-1
Class 60 Filter

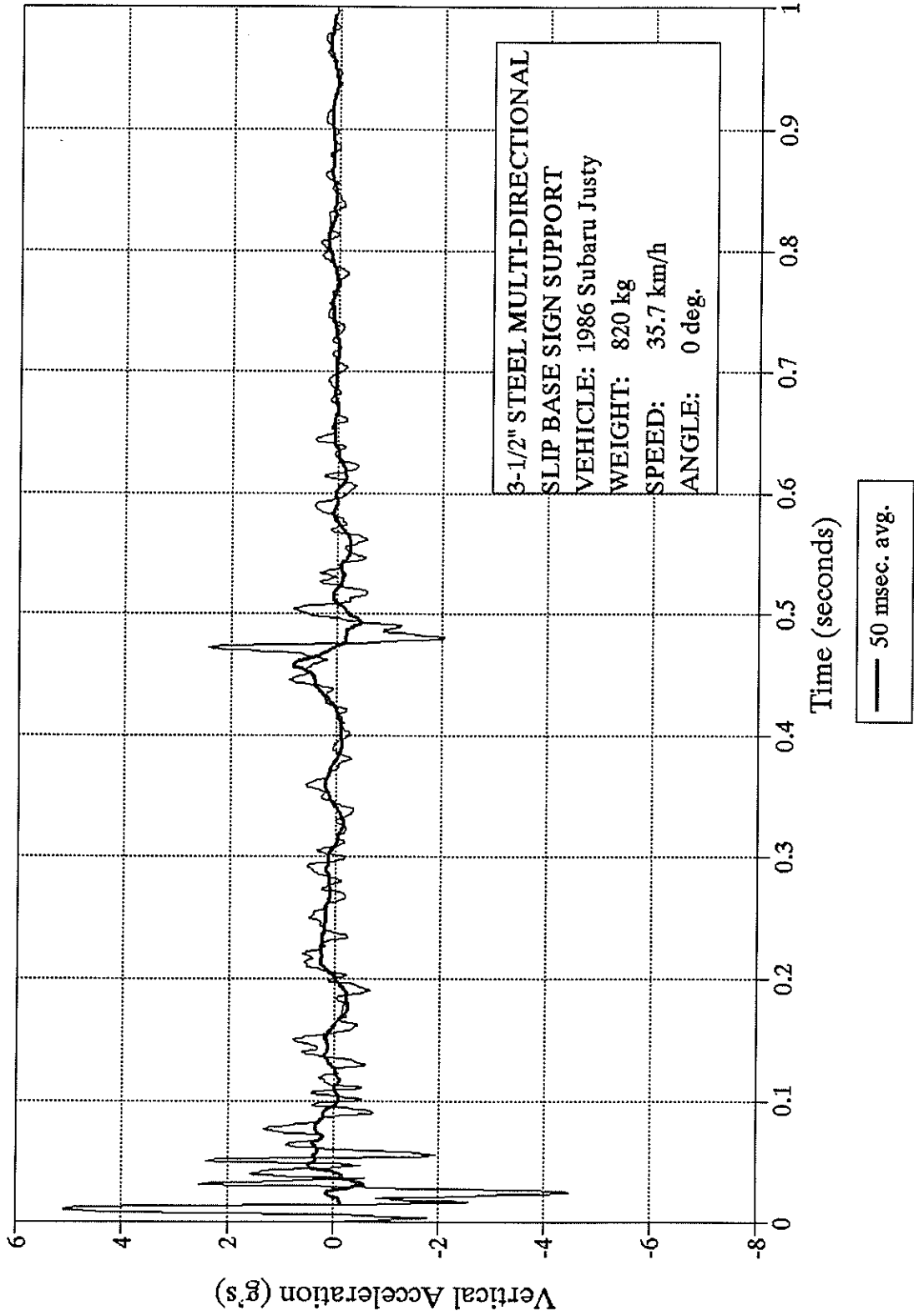

Figure 14. Vertical accelerometer trace for test 7222-1.

applicable as well because theoretical occupant contact did not occur. Change in vehicle velocity was 2.8 km/h (1.7 mi/h).

Test 7222-2

The same 1988 Subaru Justy used in Test No. 7222-1 (shown in Figure 15) was re-used in Test 7222-2. The sign installation was of the same type as Test No. 7222-1, a 8.9 cm (3-1/2 in) diameter steel pipe, multi-directional slip-base, sign installation in standard soil (shown in Figure 16). The impact was at 105.3 km/h (65.5 mi/h) using a cable reverse tow and guidance system. The point of impact was the front right quarter point of the vehicle bumper with the sign installation.

The vehicle was free wheeling and unrestrained just prior to impact. Shortly after impact, the sign support displaced the bolts in the slip-base and began to rise up off the base plate. By approximately 0.044 seconds, the vehicle had lost contact with the support. As the vehicle continued to move forward, the support moved over the top of the vehicle. Shortly thereafter, the hood began to fly open.

The impact force of the vehicle caused a wave motion to be transferred into the sign panel. Subsequently, at 0.126 second, the wave motion of the sign panel caused the panel to "walk" the top strap anchoring the sign panel to the support off the end of the support. Shortly thereafter, the lower strap failed. At approximately 0.45 seconds after impact, the brakes were applied and the vehicle came to rest 84 m (276.0 ft) from the point of impact as shown in Figure 17. Sequential photographs of the test are shown in Figure 18.

The installation yielded to the vehicle. Damage sustained to the sign installation is shown in Figure 17. The sign support came to rest 18.7 m (61.3 ft) from the point of impact and the sign panel 10.1 m (33.3 ft). The vehicle sustained moderate damage to the bumper, grill, radiator, fender and hood as shown in Figure 19. It should be noted, the extreme rearward displacement of the right front wheel is due to the lower ball joint coming out of the spindle assembly. The nut from the ball joint was found to be stripped off. It was inconclusive whether the nut was stripped off from prior fatigue or from possibly impacting the support stub. No evidence was found to conclusively support the latter. Maximum crush to the vehicle was 13.5 cm (5.3 in), located at the front right quarter of the vehicle.



Figure 15. Vehicle prior to test 7222-2.

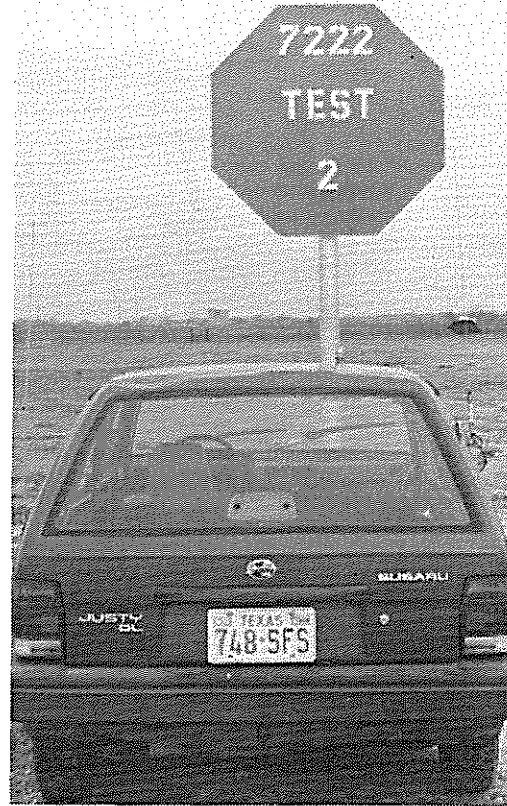

Figure 16. Vehicle/sign geometrics for test 7222-2.

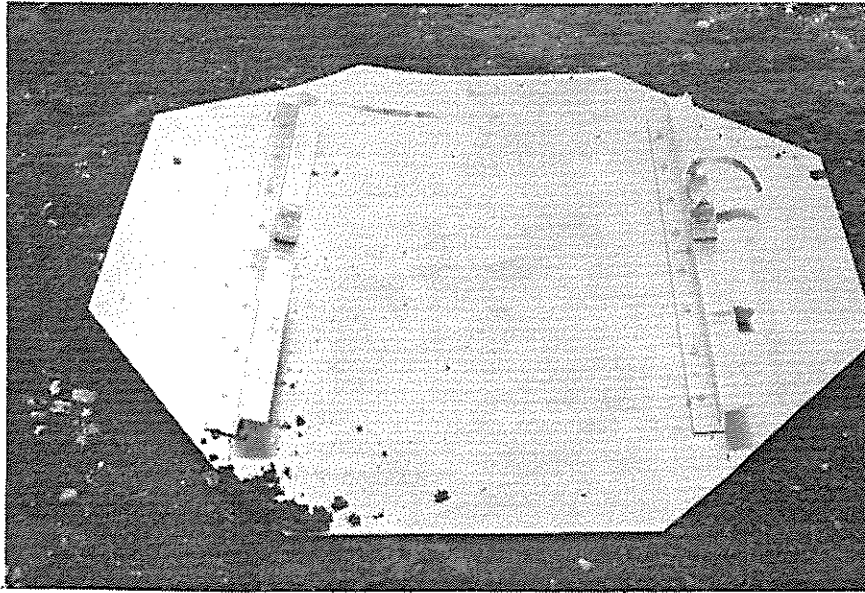
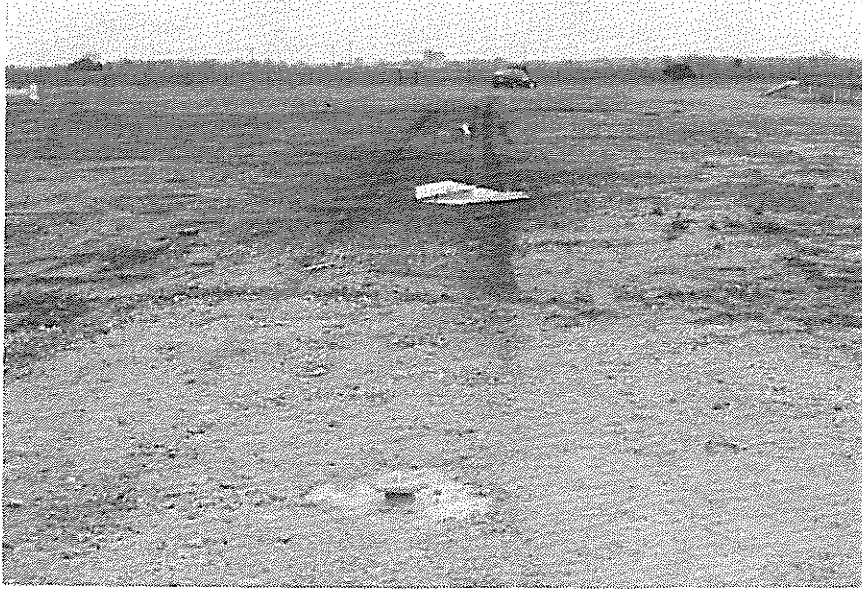

Figure 17. Sign installation after test 7222-2.

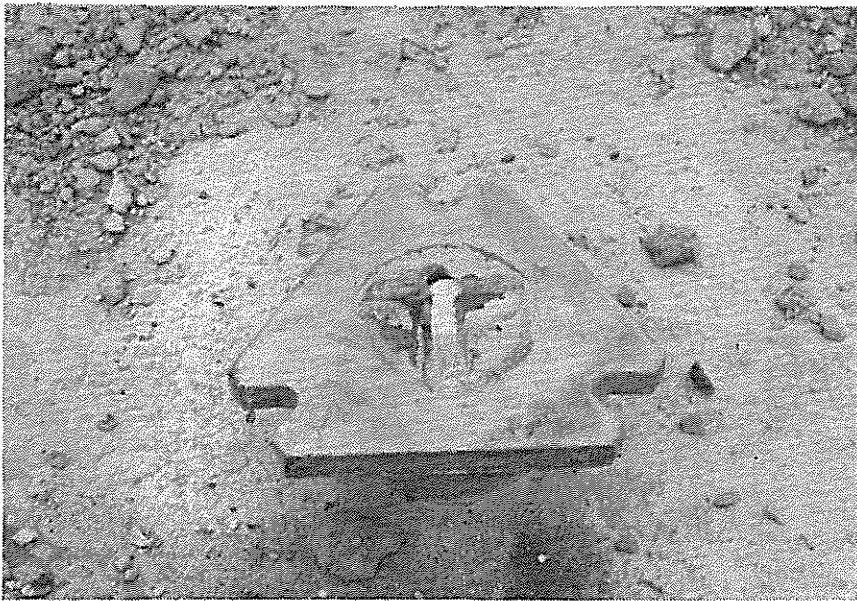
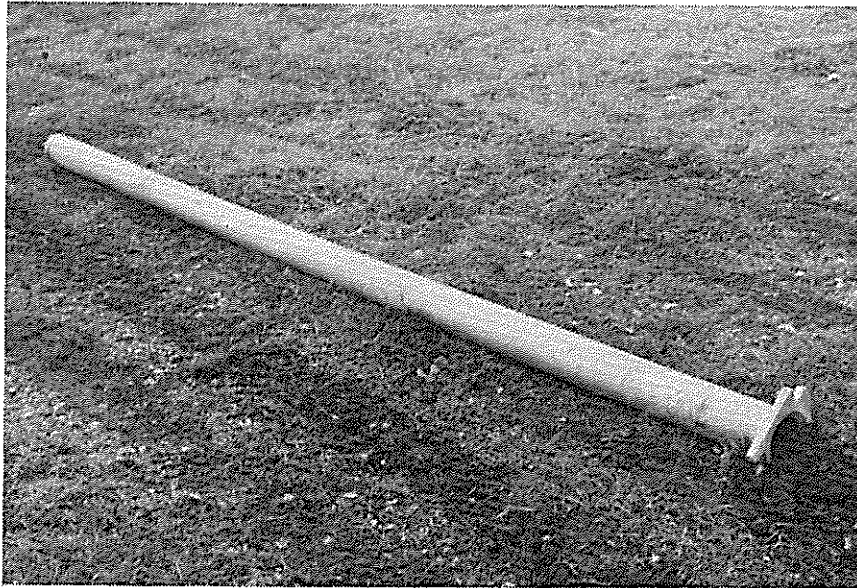
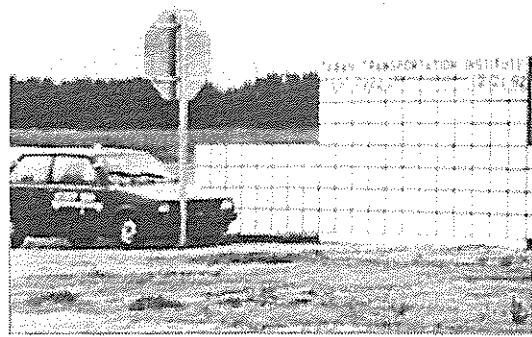
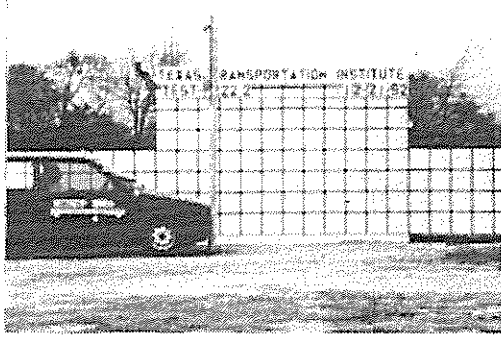
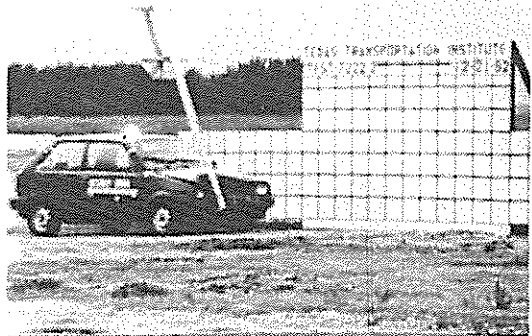
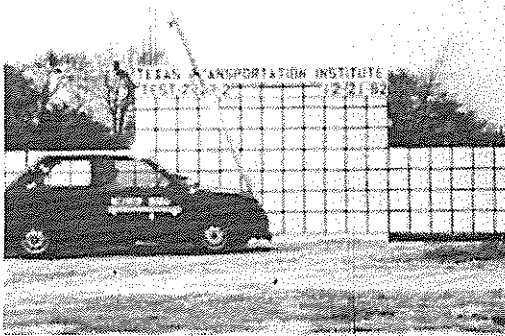

Figure 17. Sign installation after test 7222-2 (cont.).



0.000 s



0.034 s

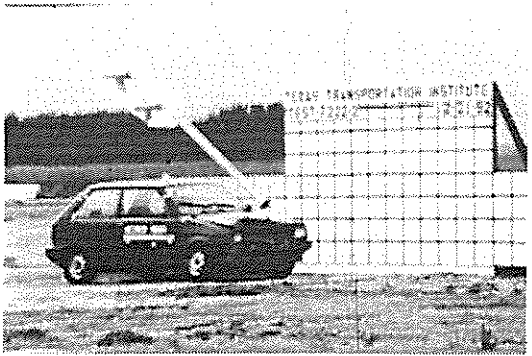
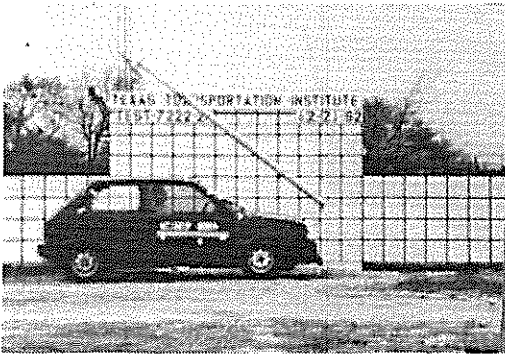

0.068 s

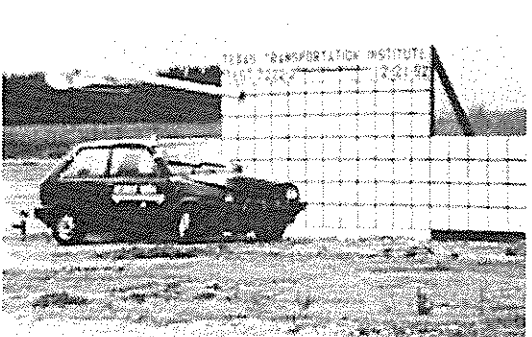
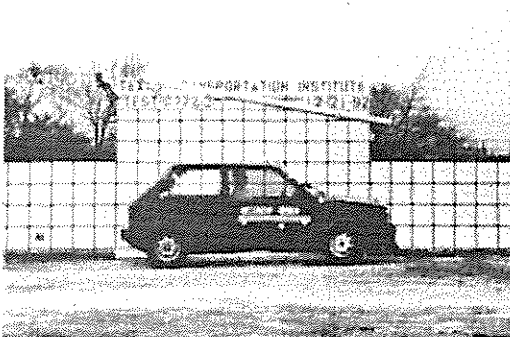

0.102 s

Figure 18. Sequential photographs for test 7222-2
(perpendicular and side views).

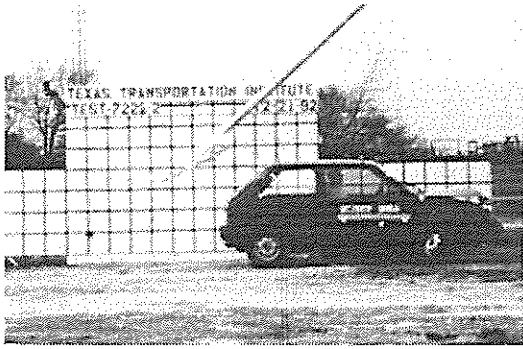

0.136 s

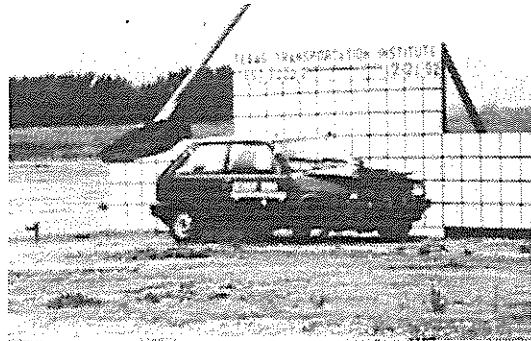
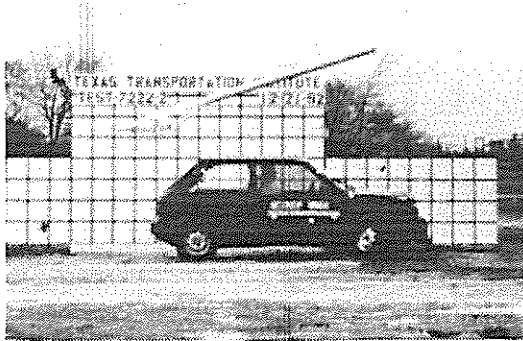

0.170 s

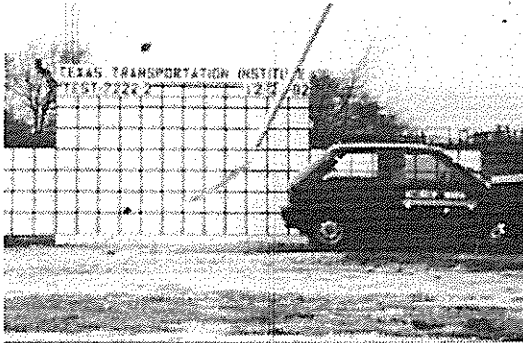

0.204 s

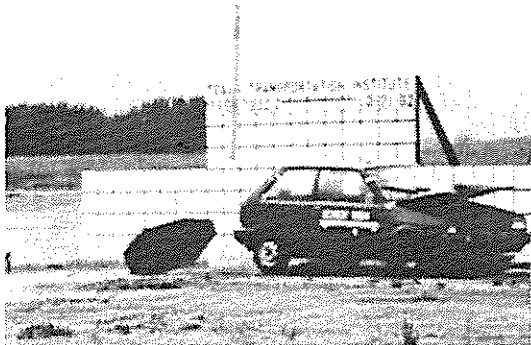
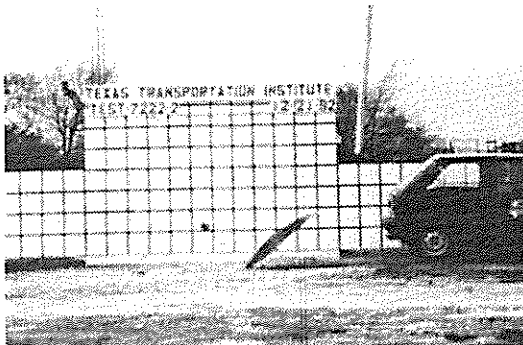

0.238 s

Figure 18. Sequential photographs for test 7222-2
(perpendicular and side views) cont.

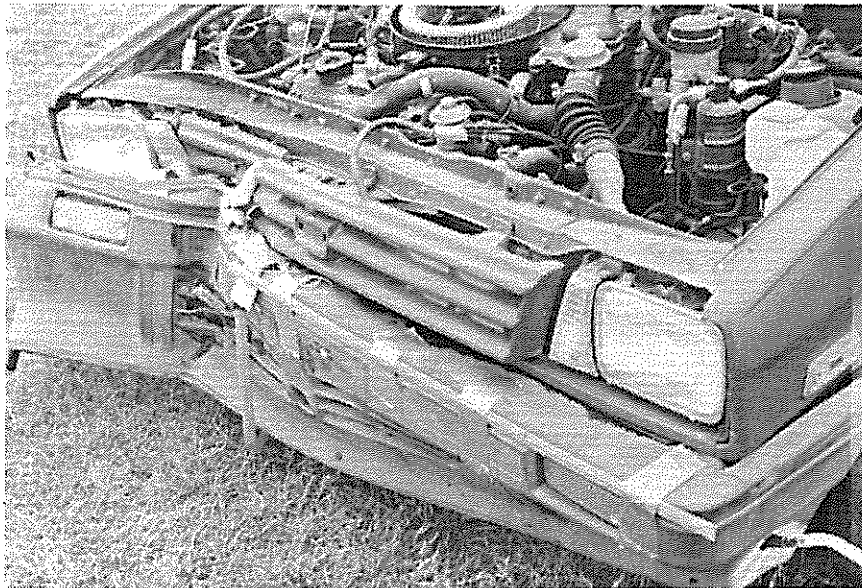
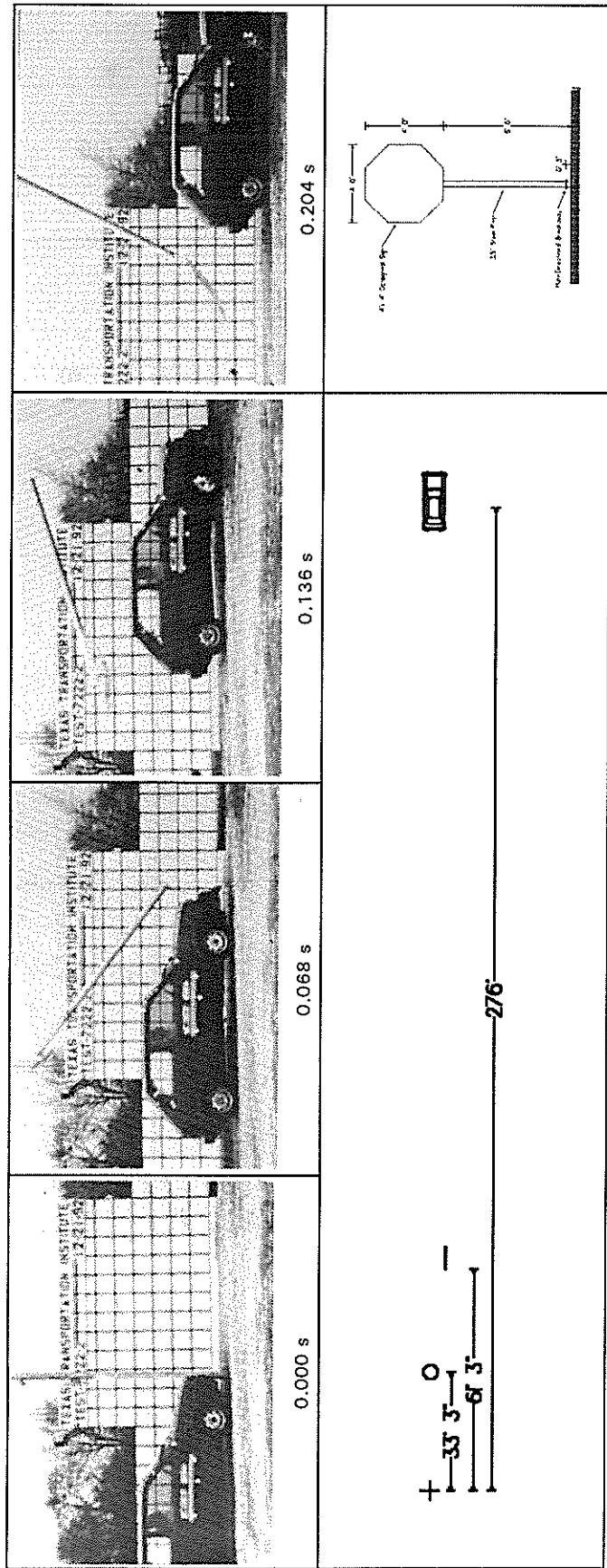

Figure 19. Damage sustained to vehicle during test 7222-2.

A summary of the test results and other information pertinent to this test are given in Figure 20. The maximum 0.050 second average acceleration experienced by the vehicle was -2.3 g in the longitudinal direction and -0.8 g in the lateral direction. Vehicle angular displacements are plotted in Figure 21 and vehicle accelerometer traces are displayed in Figures 22 through 24. Occupant impact velocity in the longitudinal and lateral direction are not applicable to this test, as theoretical occupant displacement did not reach 0.6 m (2.0 ft) longitudinal or 0.3 m (1 ft) lateral. Occupant ridedown accelerations were not applicable as well because theoretical occupant contact did not occur. Change in vehicle velocity was 5.3 km/h (3.3 mi/h).



General Information	Impact Conditions	Test Article Deflections(m)
Test Agency Texas Transportation Institute Test No. 7222-2 Date 12/21/92 Test Article Type 8.9 cm (3-1/2 in) steel, multi-directional slip base sign support Size and/or dimension and material of key elements 2.0 m (6'-6") from roadway to bottom of sign panel Soil Type and Condition NCHRP Report 350 - "Standard Soil" Test Vehicle Type Production Model Designation 820C Model 1988 Subaru Justy Mass (kg) Curb 820 kg (1,808 lb) Test Inertial 76 kg (168 lb) Dummy Gross Static 1,976 (896 kg)	Speed (km/h) 105.3 (65.5 mi/h) Angle (deg) 0 Exit Conditions Speed (km/h) 100.0 (62.2 mi/h) Angle (deg) 0 Occupant Risk Values Impact Velocity (m/s) x-direction N/A y-direction N/A THIV (optional) Ridedown Accelerations (g's) x-direction No contact y-direction No contact PHD (optional) ASI (optional) Max. 0.050-sec Averages (g's) x-direction -2.3 y-direction -0.8	Dynamic N/A Permanent N/A Vehicle Damage Exterior VDS 12FC-2 CDC 12FLLN1 Interior OCDI N/A Maximum Exterior Vehicle Crush (cm) 13.5 (5.3 in) Max. Occ. Compartment Deformation (cm) 0.0 Post-Impact Behavior Max. Roll Angle (deg) 3.3 Max. Pitch Angle (deg) 2.2 Max. Yaw Angle (deg) 6.7

Figure 20. Data summary for test 7222-2.

7222-2

— Yaw — X — Pitch — θ — Roll

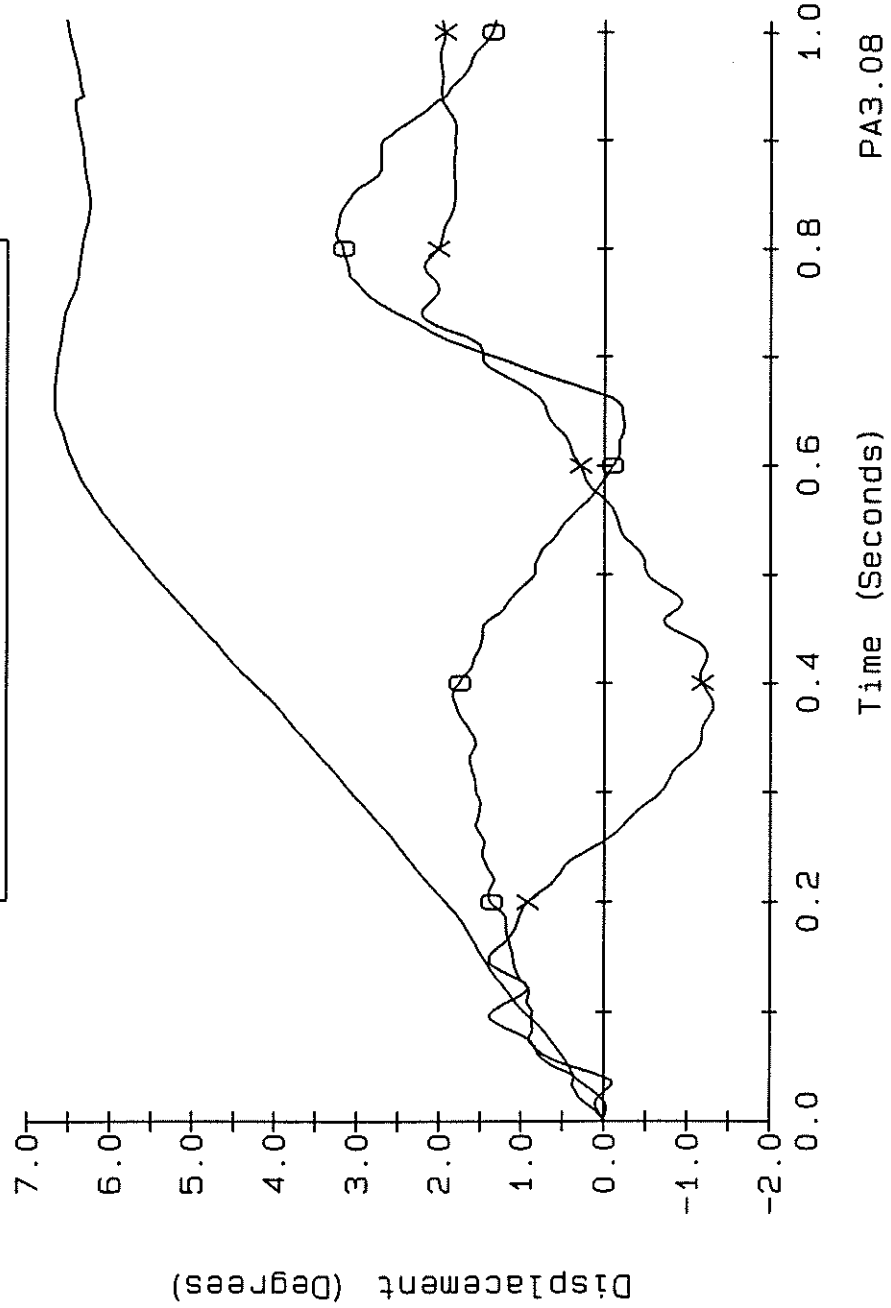

PA3.08

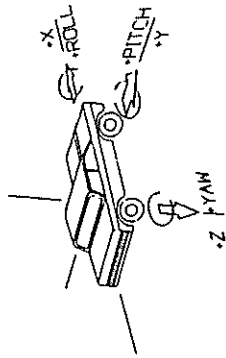

Axes are vehicle fixed.
Sequence for determining orientation is:

1. Yaw
2. Pitch
3. Roll

Figure 21. Vehicle angular displacements for test 7222-2.

Crash Test 7222-2
Class 60 Filter

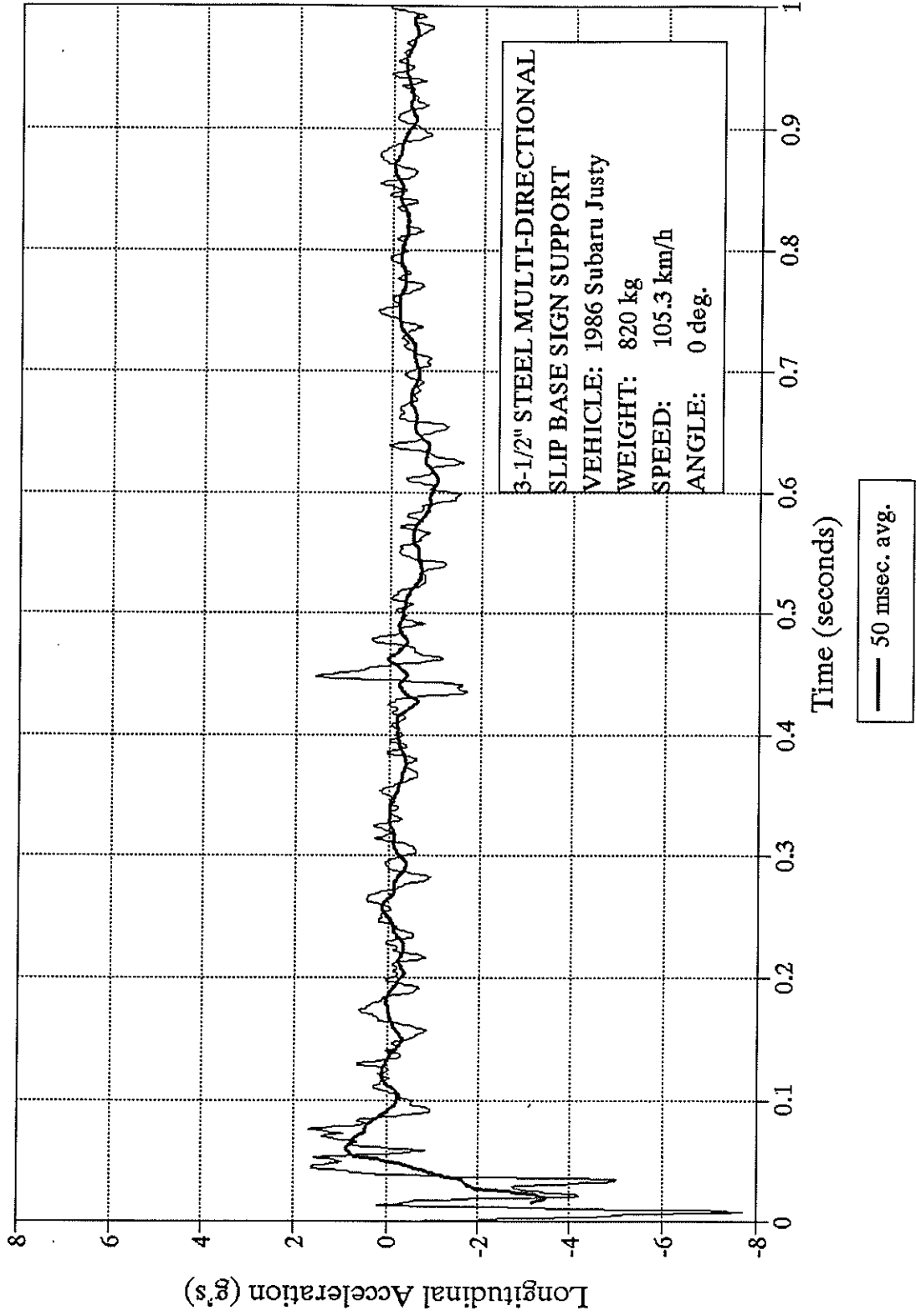

Figure 22. Longitudinal accelerometer trace for test 7222-2.

Crash Test 7222-2
Class 60 Filter

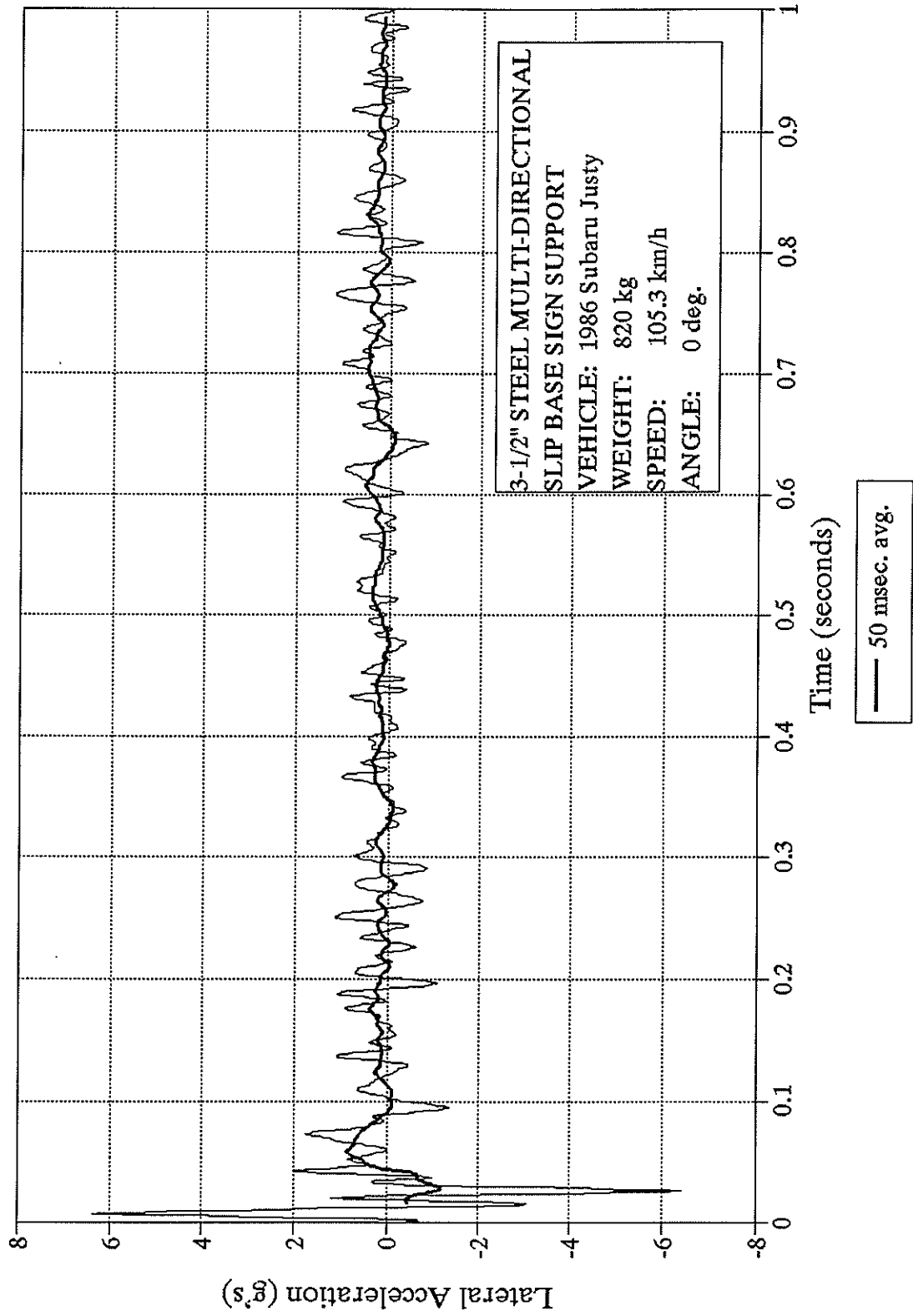

Figure 23. Lateral accelerometer trace for test 7222-2.

Crash Test 7222-2
Class 60 Filter

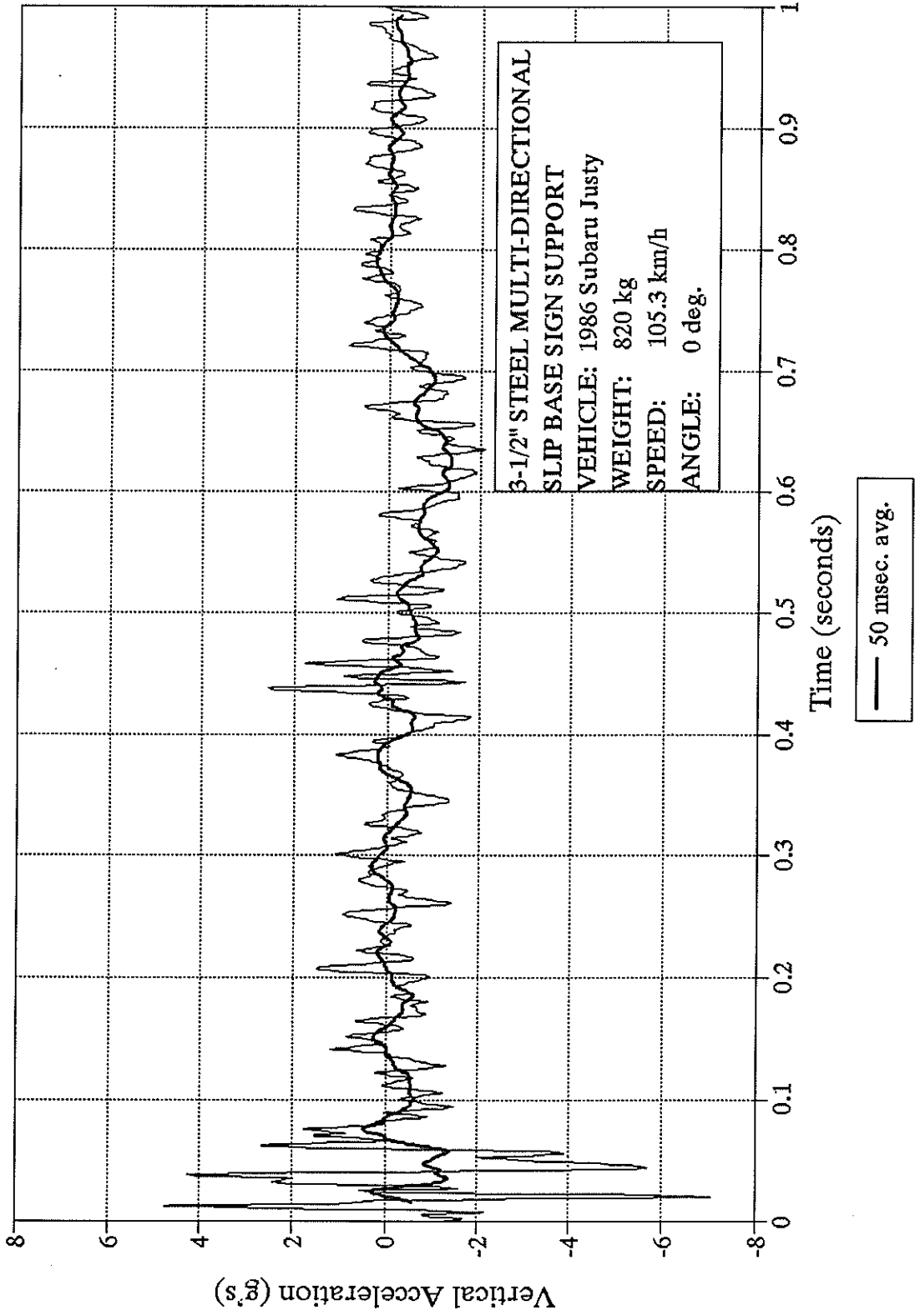

Figure 24. Vertical accelerometer trace for test 7222-2.

This page left blank intentionally.

CONCLUSION

Louisiana's multi-directional, 8.9 cm (3-1/2 in) diameter steel post, small sign support performed satisfactorily when impacted by an 820 kg (1,808 lb) vehicle at 35 km (22 mi/h) and 100 km/h (62 mi/h). The full-scale crash tests were conducted and evaluated in accordance with the criteria provided in the 1985 American Association of State Highway and Transportation Officials (AASHTO) Guide: Standards Specifications for Structural Supports for Highway Signs, Luminaires, and Traffic Signals and the National Cooperative Highway Research Program (NCHRP) Draft Report 350, test level 3.

The sign installation readily activated in a predictable manner by displacing the bolts in the slip-base. Detached elements from the sign installation did not show undue potential for penetrating the passenger compartment or present undue hazard to other traffic. It should be noted, in test 7222-2, the sign panel detached from the support, but did not present a hazard to the occupants. Further investigation of the strap failure is not warranted. The vehicle in both the low and high-speed tests remained upright and stable during and after collision. No contact to the interior of the vehicle was made by the hypothetical occupants in both the low or high-speed test.

This sign installation in "standard soil" is acceptable according to the test level 3 evaluation criteria recommended in NCHRP Report 350 and the 1985 AASHTO Standards.

This public document is published at a total cost of \$ 1,188.41. One Hundred Seventy-Five (175) copies of this public document were published in this first printing at a cost of \$ 715.91. The total cost of all printings of this document including reprints is \$ 1,188.41. This document was published by Louisiana State University, Graphic Services, 3555 River Road, Baton Rouge, Louisiana 70802, to report and publish research findings of the Louisiana Transportation Research Center as required in R.S.48:105. This material was printed in accordance with standards for printing by State Agencies established pursuant to R.S.43:31. Printing of this material was purchased in accordance with the provisions of Title 43 of the Louisiana Revised Statutes.